

University of Rajshahi

Rajshahi-6205

Bangladesh.

RUCL Institutional Repository

<http://rulrepository.ru.ac.bd>

Department of Mathematics

PhD Thesis

2005

Investigation of some aspects of protoplanetary model of planetary formation

Paul, Gour Chandra

University of Rajshahi

<http://rulrepository.ru.ac.bd/handle/123456789/908>

Copyright to the University of Rajshahi. All rights reserved. Downloaded from RUCL Institutional Repository.

Investigation of some aspects of protoplanetary model of planetary formation

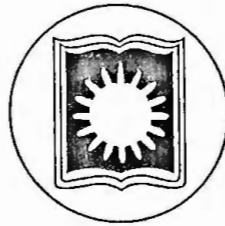

Thesis submitted for the degree of Doctor of Philosophy
in the University of Rajshahi

by

Gour Chandra Paul, M.Sc. (Raj)

April, 2005

Department of Mathematics
University of Rajshahi
Rajshahi-6205
Bangladesh

Dedicated
To
My Late Father

Professor S. K. Bhattacharjee

Department of Mathematics
University of Rajshahi
Rajshahi – 6205, Bangladesh.



Phone: (off) 750041-49/4108
(Res) 0721-750223

E-mail: skbru@yahoo.com

Fax: 0088-0721-750064

Date 21.4.05

Certificate of Originality

This is to certify that Mr. Gour Chandra Paul has worked on some aspects of protoplanetary model of planetary formation under my supervision for a Ph.D. degree. As far as I know this work is new and it has not been submitted anywhere else for the award of any degree.

I wish him success.

S. K. Bhattacharjee

(Prof. Shishir Kumar Bhattacharjee)

Supervisor

Acknowledgement

I would like to acknowledge, with gratitude, the help and guidance given to me, at all times, by my supervisor Professor Shishir Kumar Bhattacharjee.

I would like to express thanks to the Chairman, Department of Mathematics, University of Rajshahi and to all my colleagues in the Department who have helped and cooperated with me in preparing the thesis. In particular, I am grateful to Mr. Jogendra Nath Pramanik and Prof. M. Zulfikar Ali, Department of Mathematics, University of Rajshahi with whom I have had many valuable discussions.

I am thankful to Prof. Subrata Majumdar, Prof. M. Abdus Sattar, Dr. Nasima Akthar, Dr. Md. Ashabul Hoque And Mr. Kalyan Kumar Dey of the Department of Mathematics, University of Rajshahi for their constant encouragement throughout the period.

Gz. Paul

(Gour Chandra Paul)

Abstract

In this thesis we have investigated some aspects of the protoplanetary theory of planetary formation, namely, the structure of a protoplanet, sedimentation of heavy elements in a protoplanet, and the effect of mass loss on the orbit of a protoplanet.

The thesis contains five different chapters. The first chapter deals with a brief outline of the current view of planetary formation while in the other chapters we have investigated the problems under consideration.

In chapter 2, we have determined the structure of a protoplanet by numerical method in which the protoplanet is assumed to be a sphere of solar composition, which is in a steady state of quasi-static equilibrium. It is also assumed that the only source of energy in a protoplanet is gravitational. Regarding the heat transference of heat inside the protoplanet we have considered two cases of interest i) the convective case and ii) the conductive – radiative case.

In chapter 3, the distribution of thermodynamic variables in a protoplanet has been determined by polytropic method assuming that the protoplanet is a polytrope of index $n = .5, 1, 3/2$ and 3.

In the fourth chapter, we have investigated the segregation time of falling grains inside a protoplanet. We have calculated the time for two possible cases of interest, namely, i) the mass of the grain remains constant during falling, ii) the grain mass increases due to its adherence with other grains, and have found that a solid core having mass roughly equal to that of a terrestrial type planet can form at the centre of a protoplanet in a reasonable short period of time on astronomical scale.

In chapter 5, we have investigated the effect of mass loss on the orbital distance of a protoplanet in a two body problem as well as in a three body problem, and have shown that the planetary spacing observed today can satisfactorily be explained in terms of mass loss from a set of identical protoplanets.

CONTENTS

Chapter One: Planetary formation

Page No.

- | | |
|-------------------------|---|
| 1. Introduction | 1 |
| 2. Planetesimal model | 2 |
| 3. Protoplanetary model | 3 |
| 4. References | 9 |

Chapter Two: Structure of a protoplanet: Numerical method

- | | |
|---------------------------------|----|
| 1. The Model of a protoplanet | 11 |
| 2. Integration of the equations | 15 |
| 3. Summary and discussion | 28 |
| 4. References | 30 |

Chapter Three: Structure of a protoplanet: Polytopic method

- | | |
|-------------------------------------------|----|
| 1. Polytopes | 31 |
| 2. Lane-Emden equation | 33 |
| 3. Physical characteristic of a polytrope | 36 |
| 4. Application to protoplanets | 39 |
| 5. Discussion | 48 |
| 6. References | 49 |

Chapter Four: segregation of heavy elements in a protoplanet

	Page No.
1. Introduction	50
2. The model used	52
3. Summary and conclusion	73
4. References	74

Chapter Five: Orbital evolution of protoplanet with mass loss

1. Introduction	75
2. The rate of mass loss	75
3. Equation of motion and its solution	77
4. Conclusion	98
5. References	100

Chapter-1

Planetary formation

1. Introduction

The formation of the planetary system has been a topic of interest to the mankind ever since the dawn of civilization. However, scientific theories for the formation of the system largely dates from Descartes (1644) when he proposed his vortex theory of planetary formation. Since that time many theories have been advanced. In most cases these theories were primarily speculative because of the lack of observational characteristics of the system. Fortunately for the theorists of today there are some convenient observational constrains of the system. For example,

- i) There exists a central condensation, the Sun, which is many times (a factor of 750) more massive than the sum of the remaining parts of the system.
- ii) The Sun rotates very slowly, both in relation to the angular momentum present in interstellar gas clouds and in relation to the angular momentum of the planets. Infact, the sum of the angular momenta of the planets about the Sun is about 200 times larger than that of the Sun about its own axis.
- iii) There are nine known planets in orbit about the Sun.
- iv) The orbits of the planets all lie close to a well-defined plane, so that the planetary system is essentially two-dimensional. The rotation of the Sun about its own axis is also essentially in the plane.

- v) All the planets move in the same, prograde, sense round their orbits. There is also a tendency for the planets to rotate about their own axis in the same sense; while the majority of the satellites also have prograde orbits.
- vi) There exists a clear division in the chemical composition of the planets, which corresponds both to their different spatial position and to their different masses.
- vii) The orbital distances of the planets roughly follow the Titius-Bode law. This cannot be considered independently of the angular momentum of the planets. Nevertheless, some explanation is needed for the consistent increase in the distance between the planets (or in their angular momentum per unit mass) as one moves away from the Sun.
- viii) There are also some minor objects to be found in the system. They are meteorites, comets, asteroids, etc.
- ix) The age of the solar system based on the meteoritic observation is about 4.5 billion years, etc.

In the theoretical modelling of the system these constraints serve as the boundary conditions for the theorists. From time to time many theories have so far been advanced for formation of the system. Some reviews are available in, for example, Williams and Cremin (1969), Woolfson (1969), Mccrea (1972), Pickett and Lim (2004). There are found two schools of thought for formation of the solar planets: the planetesimal model and the protoplanetary model.

2. Planetesimal model

The planetesimal model is often referred to as the standard model of the formation of the solar system. In this model, the solar system formed about five billion years ago from a placental cloud of gas and dust that was cold, large and slowly rotating. The cloud collapsed, perhaps triggered by the shock wave from a nearby

supernova. Most of the mass, which was already concentrated towards the rotational axis of the cloud, fell straight to the center due to its low angular momentum. The remaining, higher angular momentum material rained down towards this central, growing protosun, but not directly, because the large spin prevented direct accretion, and so instead the material fell into a circumstellar disk. The disk is called the solar nebula. It is from the disk that the planets somehow coalesced. Close to the forming Sun, where the temperatures were high enough to vaporize most volatiles, the terrestrial planets formed by the accumulation of silicon, iron, nickel and other planetary grains into progressively larger bodies. Far from the Sun, where it stayed cool enough for various ices to form, providing additional solid material for planet building, the gas giants were born. Most of the remaining nebular material then dissipated, the thermonuclear fusion of hydrogen into helium started in the core of the Sun, and the remaining solid debris was incorporated into larger bodies, thrown into highly eccentric orbits, or incorporated, uncoalesced, in the asteroid and Kuiper belts. The result is the planetary system more or less as we know it today. The growth of planetesimals and formation of planets by accumulation of planetesimals have been and is being under thorough investigation by many, some of these investigations are those of Goldreich and Ward (1973), Greenberg, Hartman, Chapman and Walker (1978), Harris (1978), etc.

3. Protoplanetary model

In the protoplanetary picture, the planets, as we know them today, have formed from a set of identical gaseous giant protoplanets, identical in mass, radius and chemical composition, which subsequently formed planets by contraction and possibly mass loss. The most of the observed feature of the solar system is found to be explainable in this scenario of protoplanetary formation (for example, McCrea and Williams 1965, Williams and Handbury 1974, Williams and Crampin 1971, Williams and Bhattacharjee 1979). The formation of protoplanets has thus always been a topic of interest for the cosmogonists. Earlier attempts to produce

protoplanets by different mechanisms are those of McCrea (1960), Woolfson (1964) and Cameron (1978).

McCrea (1960) put forward the protoplanet theory, which as a central feature, explained both the slow rotation of the Sun and the formation of the planets. The model begins with a dense interstellar cloud that is going to form a stellar cluster. As it collapsed, it became turbulent and colliding streams of turbulent material created dense regions, which moved haphazardly in the less dense background material. These were termed floccules. When they collided they coalesced and about 20 of them would have formed a stable aggregate according to Jeans' criterion. Here and there in the cloud an aggregate would have formed of sufficient mass to act as a substantial gravitational attracter and this would eventually have become a star. Smaller aggregates would then have been captured in orbit around the star to form a planetary system.

The most detailed version of Woolfson's theory was published in 1964. In this theory, he considers the encounter between the Sun and a protostar of mass 3×10^{32} gm. The closest approach distance is taken to be 6.67×10^{14} cm, comparable to the dimensions of the planetary system. Woolfson takes the protostar to have a mean radius of the order of 3×10^{14} cm, so that its mean density and mean temperature are both very low, namely 4×10^{-12} gm cm⁻³ and 30 K respectively. It is assumed that the Sun moves past the star that is to be distorted. Woolfson produced a computer model of such a distorted star, where its interior is represented by a series of discrete point masses. The model considered is two dimensional, and most of the mass is concentrated in one point at the centre. The remainder of the star is represented by a network of points in the outer annular region, and mutual gravitational attraction between these points is considered. In a real star, pressure would keep such points apart. However, in the computer simulation, he is able to follow the material after it has left the star. He finds that this material can move in orbits with a perihelion distance ranging from 31

Astronomical Units to .05 Astronomical Units, depending on when ejection from the distorted star occurs. He concludes that these limiting distances are in very good agreement in the solar system. A study of the condensation of protoplanets indicates that, while they all lose considerable quantities of material, stable core should form which will not disrupt under solar tidal forces. However, the collapsing planetary cores will lack an axis of symmetry and it is shown that as they collapse a filament of mater should be left behind. Condensation in this filament can give rise to satellite families and approximate calculations give results consistent with the orbital characteristics of Jupiter's satellites.

Cameron (1978) put forward the protoplanet theory, which involved a very massive disk with mass equal to that of the Sun, with planets forming by direct condensation as giant protoplanets with up to 30 times the mass of Jupiter. These large bodies were then assumed to have been broken up by collisions and subsequently the debris collected together again to form a few giant planets and a large number of small bodies, the asteroids. This process would have required the disposal of a considerable mass of material but Cameron did not deal with this problem. One of the features of the model is that material falling onto the disk as it is forming gives a great deal of turbulence and hence energy dissipation. Cameron then called on a theoretical result from Lynden-Bell and Pringle (1974) that if a rotating disk evolves in such a way that its energy of rotation decreases while its angular momentum remains constant then this is achieved by material close to the spin axis moving inwards while material further out moves outwards. This is tantamount to an outward transmission of angular momentum. Another feature of this model is that it does not give the meteoriticists what they want a hot nebula. Cameron pointed out quite specifically that at no time, anywhere in the solar nebula, anywhere outwards from the formation of Mercury, is the temperature in the unperturbed solar nebula ever high enough to evaporate completely the solid materials contained in interstellar grains.

With the discovery of extra solar planets the interest in the protoplanets has rekindled. It is now widely accepted that many, perhaps most, young stars have disks around them. Some of these stars are also found to have some gas giant in orbit about the parent stars. About 10% of the stars surveyed have exoplanets, a number that is certain to improve as observation improve. These gas giants have mass comparable to Jupiter. Presumably these gas giants form from the protostellar disks. The most widely accepted explanation for gas giant formation is the core-accretion model (e.g., Mizuno 1980, Pollack 1984, Pollack et al. 1996). In this scenario, solid material, including various ices, accumulates to form the future core of a gas giant planet. The same process is responsible for the formation of the terrestrial planets (e.g., Whetherill 1990). Once a trigger mass of about 10-15 Earth masses is achieved, the core rapidly gathers nebular gas; Jupiter, for example, contains at least 300 Earth masses of hydrogen and helium. The actual accretion of the core may take anywhere from about 10 to 100 million years, depending on model dependent parameters, particularly the local surface mass density of the disk (e.g., Pollack et al. 1996). The core accretion scenario has the great advantage of working. Other authors have pointed to some of the difficulties with the model: gas giants like Jupiter may not even have appreciable cores (e.g., Guillot 1999); planetary migration, if it occurs, is a much faster phenomenon than planet building by accretion, and so the core of a proto-Jupiter would fall into the Sun before it could become massive enough to shut down migration, at least in a non turbulent nebula (e.g., Nelson et al. 2000a); it is difficult to make objects more massive than Jupiter (Boss 2002). However, the single greatest defect, and one that is very difficult to fix, is that of timescale. Even as gas, dust and ice accumulate to form the protoplanetary disk around the young protostar, the race against the time has started. We know, based on observations of young stars (e.g., Briceno et al. 2001), that stars older than about 10 million years do not have massive, optically thick circumpolar disks. Protoplanetary disk dissipate, and although the timescale for the disappearance of the disks is not entirely certain, it is on the order of or smaller than the timescale for core-accretion. Thus, by the

time a core reaches the trigger mass, the nebular gas may have disappeared. There may be exposed cores of failed gas giants in the universe, but they are not among the extrasolar planets so far detected and, at any rate, their small masses make them invisible to detection by current spectroscopic methods. It is possible that Uranus and Neptune are examples of such objects, although they might owe their relatively small gaseous envelopes to photoevaporation from nearby, massive stars (Boss 2002). In the gravitational instabilities model giants could form directly from disk via gravitational instabilities. Formation of gas giants through instability has recently been discussed by many authors (e.g., Boss 2000, 20001, 20002, 20003, Nelson et al. 2000, Rich et al. 2003). According to this model, the protoplanetary disk becomes gravitationally unstable early in its development. The manifestation of the gravitational instabilities is non-axisymmetric structure having multiarmed spirals. As spiral features intensify, and perhaps interact with each other, gaseous giant protoplanets might form from the nebular material. Since protoplanetary core formation would then occur by the sedimentation of dust and ice into the growing gas spheres, the predicted core mass should be substantially lower than the needed in the core accretion model (Boss 2002). The gravitational instability scenario is attractive, both aesthetically and scientifically. But the question is, can the gravitational instability of the disk form stable protoplanets? The answer to this question is not yet very clear. The formation of protoplanets in gravitational instability mechanism is a twin problem. It is one thing for a disk to break into spiral arms, another thing for the spirals to produce Jupiter like planets. The disk evolution has been extensively investigated in recent years by many authors (e.g., Tomley et al. 1994, Truelove et al. 1997, Nelson 2000, Pickett et al. 2003). It is found that the gravitational instability is very fast and furious and the formation of stable protoplanet is model dependent (Pickett and Lim 2004). Tidal, thermal or rotational stresses in the disk are often enough to rip apart potential protoplanets before they are fully formed (Pickett et al. 2000a, b). A recent smoothed particle hydrodynamics simulation of a protoplanetary disk is found to produce long lasting protoplanetary clumps under highly idealized

conditions (Mayer et al. 2002). However, some of the latest simulations seem to suggest that gravitational instabilities are a promising route to giant gaseous protoplanets. Assuming that protoplanets do form via gravitational instability and in course of evolution they reach a state of quasi-static equilibrium we attempt to determine the structure of a protoplanet in the next section.

4. References

- Boss, A. P., 2000. *Astrophys. J.*, 545, L61.
- Boss, A. P., 2001. *Astrophys. J.*, 563, 367.
- Boss, A. P., 2002. *Astrophys. J.*, 576, 462.
- Boss, A. P., 2003. *34th Annual Linear and Planetary Science conference abstract no.1075.*
- Briceno, C.; Vivas, A. K.; Calvet, N. H. L.; Pacheco, R.; Herrera, D; Romero, L.; Berlind, P.; Sanchez, G.; Snyder, J. A. and Andrew, P., 2001. *Science*, 291, 93.
- Cameron, A. G. W., 1978. *The origin of the solar system*, P. 49, ed. Dermott, S. F. Wiley, Chichester.
- Descartes, R., 1644. *Principia Philosophiae*, Amsterdam.
- Goldreich, P. and Ward, W. R., 1973. *Ap. J.*, 183, 1051.
- Greenburg, R. G., Hartman, W. K., Chapman, C. R. and Walker, J. F., 1978. *Protostars and planets*, ed. Gehrels, T., University of Arizona Press.
- Guillot, T., 1999. *Planet Space Sci.*, 47, 1183.
- Harris, A. W., 1978. *The Origin of the Solar System*, ed. Dermott, S. F., Wiley, J. & Sons Pub. Co..
- Lynden-Bell, D. and Pringle, J. E., 1974. *Mon. Not. R. Astr. Soc.*, 168, 603.
- Mayer, L.; Quinn, T.; Wadsley, J. and Stadal, J., 2002. *Science*, 298, 1756.
- McCrea, W.H. and Williams, I. P., 1965. *Proc. Roy. Soc.*, A, 287, 143
- McCrea, W. H., 1972. *Proceedings Nice Symposium on the Origin of the Solar System*, p. 2.
- McCrea, W. H., 1960. *Proc. Roy. Soc.*, London, A, 256, 245.
- Mizuno, H., 1980. *Progr. Theor. Phys.*, 64, 544.
- Nelson, A. F.; Benz, W. and Ruzmaikina, T. V., 2000. *Astrophys. J.*, 529, 357.
- Nelson, R. P.; Papaloizou, J. C. B.; Masset, F. and Kley, W., 2000a. *MNRAS*, 318, 18.
- Pickett, B. K.; Cassen, P.; Durisen, R. H. and Link, R., 2000a. *Astrophys. J.*, 529, 1034.

- Pickett, B. K.; Durisen, R. H.; Cassen, P. and Mejia, A. C., 2000b. *Astrophys. J.*, 540, L95.
- Pickett, B. K.; Mejia, A. C.; Durisen, R. H. Cassen, P.; Berry, D. K. and Link, R. P., 20003. *Astrophysical J.*, 590, 1060.
- Pickett, M. K. and Lim, A. J., 2004. *Astr. and Geophys.*, 45, 1.12.
- Pollack, J. B., 1984. *ARAA*, 22, 389.
- Pollack, J. B., 1996. *ARAA*, 22, 389.
- Pollack, J. B.; Hubickyj, o.; Bodenheimer, p.; Lissauer, J. J.; Podolak, M. and Greenzweig, Y., 1996. *Icarus*, 124, 62.
- Rice, W. K. M.; Armitage, P. J.; Bate, M. R. and Bonnell, I. A., 2003. *MNRAS*, 339, 1025.
- Tomley, L.; Steiman-Cameron, T. Y. and Cassen, P., 1994. *Ap. j.*, 422, 850.
- Truelove, J. K.; Klein, R. I.; McKee, C. F. Holliman, J. H., II; Howell, L H. and Greenough, J. A., 1997. *Astrophys. J.*, 489, L179.
- Whetherill, G. W., 1990. *Ann. Rev. Earth Planet Sci.*, 18, 205.
- Williams, I. P. and Bhattacharjee, S. K., 1979. *Astrophys. Space Sci.*, 66, 319.
- Williams, I. P. and Cremin, A. W., 1969. *MNRAS*, 44, 359.
- Williams, I. P. and Handbury, M. J., 1974. *Astrophys. Space Sci.*, 30, 215.
- Williams, I. P. and Crampin, D. J., 1971. *Mon. Not. R. Astr. Soc.*, 152, 261.
- Wolfson, M. M., 1964. *Proc. Roy. Soc.*, A, 282, 485.
- Wolfson, M. M., 1969. *Prog. Phys.*, 32, 135.

Chapter-2

Structure of a protoplanet: Numerical method

1. The Model of a protoplanet

By a protoplanet we mean a non-rotating nonmagnetic spherical gaseous object of mass $M = 2 \times 10^{30}$ gm and radius $R = 3 \times 10^{12}$ cm, as suggested by several authors (e.g., McCrea 1960, McCrea and Williams 1965). The object is assumed to be in a steady state of quasi-static equilibrium in which ideal gas laws hold. We also assume that there is no nuclear energy source in the protoplanet. The only source of energy is gravitational. For heat transfer inside the protoplanet we consider two possible cases of interest, namely, i) the convective case and ii) the conductive-radiative case. The temperature gradient for convective heat flux is given by (e.g., Schwarzschild 1958)

$$\frac{dT}{dr} = \left(1 - \frac{1}{\gamma}\right) \frac{T}{P} \frac{dP}{dr}, \quad (2.1)$$

where T is the temperature, P the pressure, γ the ratio of specific heats, and r is the usual radial distance.

For heat flux in the conductive-radiative case we follow Erika Bohm-Vitense (1997) in which the formulation states that the total heat flux in which both conduction and radiation play their role in transference of heat is given by

$$F(r) = 4\pi r^2 \left(-\frac{16}{3K} \sigma T^3 \frac{dT}{dr} \right) \quad (2.2)$$

with

$$\frac{1}{K} = \frac{1}{K_{cm}} + \frac{1}{K_{hc}}. \quad (2.3)$$

Here K_{cm} is the radiative absorption coefficient and $K_{hc} = \frac{16}{3}\sigma T^3 / \eta$ is the conductive absorption coefficient where σ is the Stefan-Boltzmann constant and η is the thermal conductivity of the gas.

In a protoplanet, the source of energy being gravitational, some energy will be released due to its slow contraction. Half of this released energy is used to raise the internal temperature and the other half goes through radiation. However, the system is in a steady state, so no heat will go into raising the temperature. Therefore, all energy released will be available for energy flux. If we consider a spherical surface of radius r inside a protoplanet of radius R , the amount of energy available as the heat flux through the sphere of radius r is given by

$$F(r) = -\frac{dE(r)}{dt},$$

where $E(r)$ is the total energy of the system of radius r .

Now,

$$E(r) = -\lambda \frac{GM^2(r)}{r}, \text{ as is discussed in the next section,}$$

where λ is a constant of order unity whose value depends on the internal structure of the system, G the universal gravitational constant and $M(r)$ is the mass inside radius r .

Therefore,

$$F(r) = \lambda \frac{GM^2(r)}{r^2} \frac{dr}{dt},$$

since $M(r)$ remains constant during contraction.

$$\text{or } F(r) = \lambda \frac{GM^2(r)}{r^2} \frac{dr}{dR} \frac{dR}{dt}. \quad (2.4)$$

For uniform contraction,

$$\frac{dR}{dt} = \mu, \text{ a constant} \quad (2.5)$$

and
$$\frac{dr}{dR} = \frac{r}{R}. \quad (2.6)$$

Therefore, with the help of the equations (2.5) and (2.6), from equation (2.4), we have

$$\begin{aligned} F(r) &= \lambda\mu \frac{GM^2(r)}{r^2} \frac{r}{R} \\ &= \frac{C}{R} \frac{GM^2(r)}{r}, \text{ where } \lambda\mu = C. \end{aligned} \quad (2.7)$$

Here C is an unknown constant. We shall consider this constant as a free parameter.

From equations (2.2) and (2.7), we get

$$-\frac{16}{3K} \sigma T^3 \frac{dT}{dr} = \frac{C}{4\pi R} \frac{GM^2(r)}{r^3}.$$

Substituting for $\frac{1}{K}$ from equation (2.3), we get

$$-\frac{16}{3} \sigma T^3 \frac{dT}{dR} \left(\frac{1}{K_{cm}} + \frac{1}{K_{hc}} \right) = \frac{C}{4\pi R} \frac{GM^2(r)}{r^3}.$$

Substituting for K_{hc} , we have

$$\left(\frac{16\sigma T^3(r)}{3K_{cm}} + \eta \right) \frac{dT(r)}{dr} = -C \frac{GM^2(r)}{4\pi R r^3}. \quad (2.8)$$

Now, $K_{cm} = nK_{at}$ (Erika 1997), where n is the number of particles per unit volume and K_{at} is the absorption cross section of each particle. It is found that K_{at} is roughly equal to $2 \times 10^{-24} \text{ cm}^2$ (Erika 1997). With this value K_{cm} becomes

$$K_{cm} \approx \frac{2 \times 10^{-24} \rho(r)}{H},$$

where H is the mass of a hydrogen atom.

Substituting this value of K_{cm} in equation (2.8), we have the conductive-radiative flux in the form

$$\left(\frac{8\sigma H}{3 \times 10^{-24}} \frac{T^3(r)}{\rho(r)} + \eta \right) \frac{dT(r)}{dr} = -\frac{C}{4\pi R} \frac{GM^2(r)}{r^3}. \quad (2.9)$$

The structure of a protoplanet in its quasi-static equilibrium state is then given by the following set of equations:

The equation of hydrostatic equilibrium,

$$\frac{dP(r)}{dr} = \frac{GM(r)}{r^2} \rho(r). \quad (2.10)$$

The equation of conservation of mass,

$$\frac{dM(r)}{dr} = 4\pi r^2 \rho(r). \quad (2.11)$$

The equation of convective heat flux,

$$\frac{dT}{dr} = \left(1 - \frac{1}{\gamma} \right) \frac{T}{P} \frac{dP}{dr}. \quad (2.12)$$

The equation of conductive-radiative heat flux,

$$\left(\frac{8\sigma H}{3 \times 10^{-24}} \frac{T^3(r)}{\rho(r)} + \eta \right) \frac{dT(r)}{dr} = -\frac{C}{4\pi R} \frac{GM^2(r)}{r^3}. \quad (2.13)$$

The gas law,

$$\rho = \frac{k}{\mu H} \mathfrak{R}T. \quad (2.14)$$

In the above equations $T(r)$, $P(r)$ and $\rho(r)$ give the temperature, pressure and the density respectively at distance r from the centre of the protoplanet.

Boundary conditions

Considering a sphere of infinitesimal radius r at the centre, we find that

$$M(r) = \frac{4}{3} \pi r^3 \rho,$$

since we may treat ρ sensibly constant in this sphere. Hence as $r \rightarrow 0$, $M(r) \rightarrow 0$.

It is also clear that $M(r) = M$ at the surface, i.e., at $r = R$.

In addition, we may derive suitable conditions for pressure and temperature of a protoplanet at its surface. The protoplanets having cold origin must have low surface temperature. In the first approximation we assume that the surface temperature is zero. So the approximate boundary conditions are

$$T = 0, P = 0 \text{ at } r = R,$$

$$M(r) = M \quad \text{at } r = R$$

with $M(r) = M \quad \text{at } r = 0.$

2. Integration of the equations

It is evident that the equations of structure can not be integrated analytically. Therefore, we must rely on numerical method. However, integration can not be started right from the surface. This complication arises from the fact that at the boundary vanishing denominators occur in the basic differential equations (2.10), (2.11), (2.12) and (2.13). Therefore, one has to develop the solution at the boundary, use the development to compute the solution at point little distance from the boundary, and start at this point step-by-step integration procedure.

Transformation

Let us replace the physical variables $P(r)$, $T(r)$, $M(r)$ and r by the non dimensional variables p , t , q and x respectively with the help of the following transformations (Schwarzschild 1946):

$$P(r) = \frac{GM^2}{4\pi R^4} p,$$

$$T(r) = \frac{\mu HGM}{kR} t,$$

$$M(r) = qM$$

and

$$r = xR.$$

Here the symbol μ represents the mean molecular weight given by

$$\mu = \frac{1}{2X + \frac{3}{4}Y + \frac{1}{2}Z},$$

where X , Y and Z denoting the abundances by weight of hydrogen, helium and the heavy elements respectively. For standard solar composition $\mu \approx .6$.

Then from equation (2.10), we get

$$\frac{GM^2}{4\pi R^4} \frac{1}{R} \frac{dp}{dx} = -G \frac{qM}{x^2 R^2} \frac{M}{4\pi R^3} \frac{p}{t},$$

since from equation (2.14),

$$\rho(r) = \frac{M}{4\pi R^3} \frac{p}{t}$$

or

$$\frac{GM^2}{4\pi R^5} \frac{dp}{dx} = -\frac{GM^2}{4\pi R^5} \frac{pq}{tx^2}$$

or

$$\frac{dp}{dx} = -\frac{pq}{tx^2}. \quad (2.15)$$

From equation (2.11), we get

$$\frac{M}{R} \frac{dq}{dx} = 4\pi x^2 R^2 \frac{M}{4\pi R^3} \frac{p}{t}$$

or

$$\frac{dq}{dx} = \frac{px^2}{t}. \quad (2.16)$$

Again from (2.12),

$$\frac{\mu HGM}{kR} \frac{1}{R} \frac{dt}{dx} = \left(1 - \frac{1}{\gamma}\right) \frac{\mu HGM}{kR} \frac{4\pi R^4}{GM^2} \frac{GM^2}{4\pi R^4} \frac{1}{R} \frac{dp}{dx}$$

or
$$\frac{dt}{dx} = \left(1 - \frac{1}{\gamma}\right) \frac{t}{p} \frac{dp}{dx}, \quad (2.17)$$

Substituting for $\frac{dp}{dx}$ from (2.15), we have

$$\frac{dt}{dx} = -\left(1 - \frac{1}{\gamma}\right) \frac{t}{p} \frac{pq}{tx^2}$$

or
$$\frac{dt}{dx} = -\left(1 - \frac{1}{\gamma}\right) \frac{q}{x^2}. \quad (2.18)$$

Also from (2.13), we get

$$\left\{ \frac{8\sigma H}{3 \times 10^{-24}} \left(\frac{\mu HGM}{kR} \right)^3 t^3 + \eta \frac{p}{t} \frac{M}{4\pi R^3} \right\} \frac{\mu HGM}{kR^2} \frac{dt}{dx} = -C \frac{GM^3}{16\pi^2 R^7} \frac{pq^2}{tx^3}$$

or
$$\left\{ \frac{8\sigma H}{3 \times 10^{-24}} \left(\frac{\mu HGM}{kR} \right)^3 t^3 + \eta \frac{p}{t} \frac{M}{4\pi R^3} \right\} \frac{\mu H}{k} \frac{dt}{dx} = -C \frac{M^2}{16\pi^2 R^5} \frac{pq^2}{tx^3}$$

or
$$\left\{ \frac{8\sigma H}{3 \times 10^{-24}} \left(\frac{\mu HGM}{kR} \right)^3 t^3 + \eta \frac{p}{t} \frac{M}{4\pi R^3} \right\} \frac{dt}{dx} = -C \frac{M^2 k}{16\pi^2 R^5 \mu H} \frac{pq^2}{tx^3}$$

or
$$\left\{ \frac{8\sigma H}{3 \times 10^{-24}} \left(\frac{\mu HGM}{kR} \right)^3 t^4 + \eta p \frac{M}{4\pi R^3} \right\} \frac{dt}{dx} = -C \frac{M^2 k}{16\pi^2 R^5 \mu H} \frac{pq^2}{x^3}$$

or
$$(\alpha t^4 + \beta p) \frac{dt}{dx} = -C \gamma \frac{pq^2}{x^3}, \quad (2.19)$$

where
$$\alpha = \frac{8\sigma H}{3 \times 10^{-24}} \left(\frac{\mu HGM}{kR} \right)^3,$$

$$\beta = \frac{M\eta}{4\pi R^3}$$

and
$$\gamma = \frac{M^2 k}{16\pi^2 R^5 \mu H}$$

Inserting the parameters involved, namely, $\sigma = 5.6686 \times 10^{-5}$ erg cm⁻² deg⁴ sec,
 $H = 1.67352 \times 10^{-24}$ gm, $R = 3 \times 10^{12}$ cm, $\mu = .6$, $G = 6.675 \times 10^{-8}$ dyne cm² gm⁻²,

$M = 2 \times 10^{30}$ gm, $\eta = 1.2684 \times 10^4$ erg cm⁻¹ s⁻¹ K⁻¹ and $k = 1.38062 \times 10^{-16}$ erg molecule⁻¹ K⁻¹, we get

$$\alpha = \frac{8 \times 5.6686 \times 10^{-5} \times 1.67352 \times 10^{-24}}{3 \times 10^{-24}} \times \left(\frac{.6 \times 1.67352 \times 10^{-24} \times 6.675 \times 10^{-8} \times 2 \times 10^{30}}{1.38062 \times 10^{-16} \times 3 \times 10^{12}} \right)^3$$

$$= 8.5759 \times 10^3,$$

$$\beta = \frac{2 \times 10^{30} \times 1.2684 \times 10^4}{4 \times 3.14159 \times (3 \times 10^{12})^3} = 7.4768 \times 10^{-5}$$

and

$$\gamma = \frac{(2 \times 10^{30})^2 \times 1.38062 \times 10^{-16}}{16 \times (3.14159)^2 \times (3 \times 10^{12})^5 \times .6 \times 1.67352 \times 10^{-24}}$$

$$= 1.4333 \times 10^4.$$

To summarise, the non-dimensional equations of structure are given by

$$\frac{dp}{dx} = -\frac{pq}{tx^2}, \quad (2.20)$$

$$\frac{dq}{dx} = \frac{px^2}{t}, \quad (2.21)$$

$$\frac{dt}{dx} = -\left(1 - \frac{1}{\gamma}\right) \frac{q}{x^2} \quad (2.22)$$

and

$$(\alpha t^4 + \beta p) \frac{dt}{dx} = -C\gamma \frac{pq^2}{x^3}. \quad (2.23)$$

The boundary conditions being

$$t = 0, \quad p = 0 \quad \text{at } x = 1,$$

$$q = 1 \quad \text{at } x = 1$$

with

$$q = 0 \quad \text{at } x = 0$$

i) Solution for the convective case

For this case we have to solve the equations (2.20), (2.21) and (2.22).

For mono atomic gas $\gamma = 5/3$, then equation (2.22) reduces to

$$\frac{dt}{dx} = -\frac{2}{5} \frac{q}{x^2}. \quad (2.24)$$

If we introduce the variable $\xi = \frac{1}{x} - 1$, then

$$\frac{dp}{dx} = \frac{dp}{d\xi} \frac{d\xi}{dx}$$

or
$$\frac{dp}{dx} = -\frac{dp}{d\xi} \frac{1}{x^2}$$

or
$$\frac{dp}{dx} = -(\xi + 1)^2 \frac{dp}{d\xi}.$$

Hence from equation (2.15), we get

$$-(\xi + 1)^2 \frac{dp}{d\xi} = -(\xi + 1)^2 \frac{pq}{t}$$

or
$$\frac{dp}{d\xi} = \frac{pq}{t}. \quad (2.25)$$

Similarly from (2.16) and (2.17), we get

$$\frac{dq}{d\xi} = -\frac{p}{t(1+\xi)^4} \quad (2.26)$$

and
$$\frac{dt}{d\xi} = \frac{2}{5} q. \quad (2.27)$$

Near the surface $q \approx 1$, then from (2.27), we have

$$\frac{dt}{d\xi} = \frac{2}{5}. \quad (2.28)$$

Integrating (2.28), we have

$$t = \frac{2}{5}\xi + d,$$

where d is an integrating constant.

When $\xi = 0$, then $t = 0$ and hence $d = 0$.

Therefore, near the surface $t \approx \frac{2}{5}\xi$.

From (2.25) and (2.28), we get

$$\frac{dp}{dt} = \frac{\frac{dp}{d\xi}}{\frac{dt}{d\xi}} = \frac{\frac{p}{2}}{\frac{t}{5}}$$

or
$$\frac{dp}{dt} = \frac{5}{2} \frac{p}{t}. \quad (2.29)$$

Integrating (2.29), we get

$$p = et^{\frac{5}{2}},$$

where e is the constant for integration. We will consider this constant as a free parameter.

We solve the equations (2.25), (2.26) and (2.27) with the help of the 4th order Runge-Kutta method using the boundary conditions given by $p = et^{\frac{5}{2}}$, $q = 1$ and $t = .4\xi$. In general it is found that these equations hold good accuracy from the surface inwards for some values of ξ near to zero.

If we put $\xi = \frac{y}{1-y}$, we have

$$\frac{dp}{dy} = \frac{dp}{d\xi} \frac{d\xi}{dy}$$

or
$$\frac{dp}{dy} = \frac{dp}{d\xi} \frac{1}{(1-y)^2}$$

or
$$\frac{dp}{d\xi} = (1-y)^2 \frac{dp}{dy}.$$

Hence from equation (2.25), we have

$$(1-y)^2 \frac{dp}{dy} = \frac{pq}{t}$$

or
$$\frac{dp}{dy} = \frac{pq}{t(1-y)^2}. \quad (2.30)$$

Similarly from (2.26) and (2.27), we get

$$\frac{dq}{dy} = -\frac{p(1-y)^2}{t} \quad (2.31)$$

and
$$\frac{dt}{dy} = \frac{4q}{(1-y)^2} \quad (2.32)$$

respectively.

Equations (2.30), (2.31) and (2.32) give the equations of structure in the convective equilibrium in the new variable y . It is evident that as $\xi \rightarrow 0$, $y \rightarrow 0$.

Therefore, the forms of the variables near the surface are $p = \left(\frac{.4y}{1-y}\right)^5 e$,

$$t = \frac{.4y}{1-y} \text{ and } q \approx 1.$$

If we start the integration inwards from a point very near to the surface, say, $y = .01$, then at that point

$$t = \left(\frac{.4y}{1-y}\right)_{y=.01} = 4.0404 \times 10^{-3},$$

$$p = \left[\left(\frac{.4y}{1-y}\right)^{\frac{5}{2}} e \right]_{y=.01} = 1.0377 \times 10^{-6} e \text{ and } q \approx 1.$$

With these boundary conditions equations (2.30), (2.31) and (2.32) can be integrated step by step inwards for given value of e . But e is not known.

Borrowing the idea from Osterbrock (1953) we have considered a number of trial values of e , namely, $e = 45, 45.2, 45.4, 45.7$ and 46 . For these values of e we have solved equations (2.30), (2.31) and (2.32) numerically by the 4th order Runge-Kutta method.

Now,
$$\xi = \frac{1}{x} - 1 = \frac{y}{y-1}. \text{ This gives } x = 1 - y.$$

That means x can be calculated for given y . Therefore, solutions of equations (2.30), (2.31) and (2.32) for different y can easily be converted to solutions for different x . Some of these calculations for mass distribution are shown in the figure 2.1.

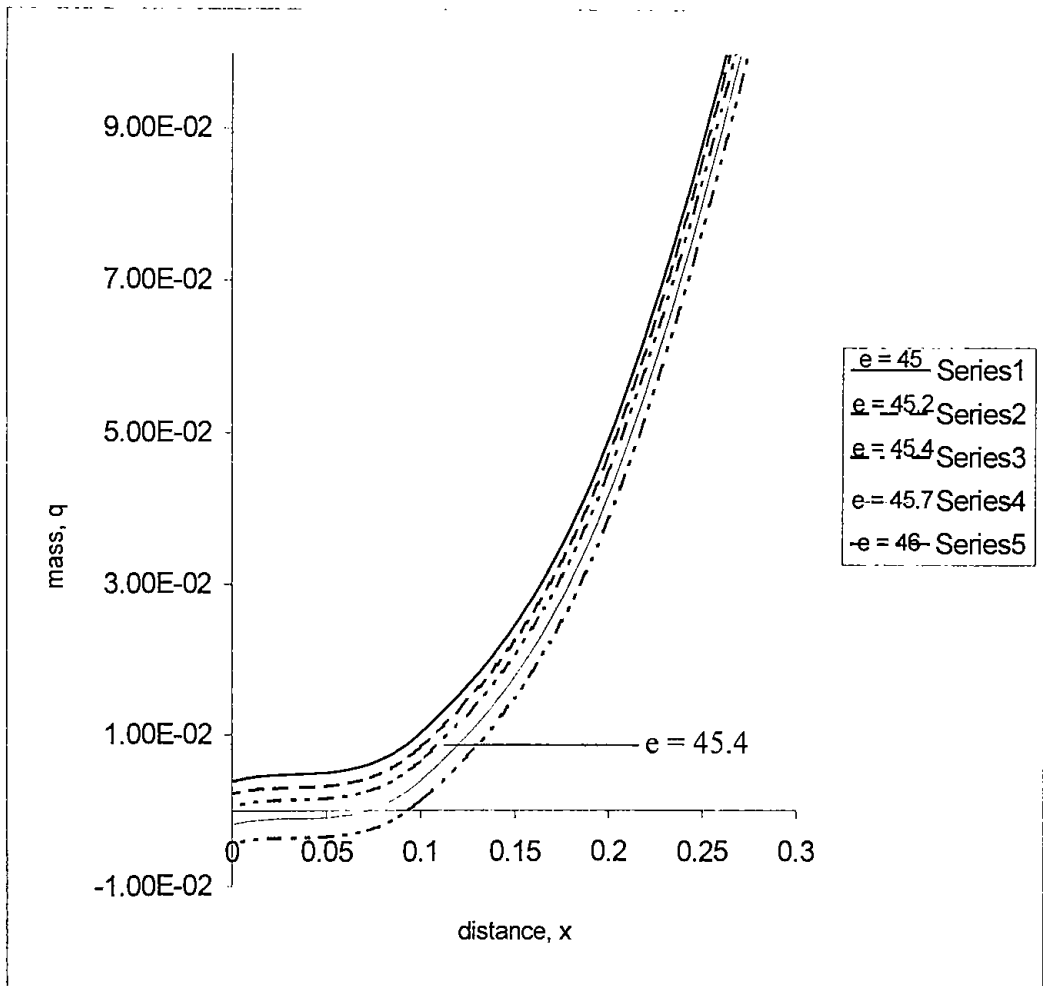

Fig. 2.1: Mass distribution in a protoplanet for different values of e .

The correct value of e will be for which the central boundary condition, $q = 0$ at $r = 0$ is satisfied. From the diagram the correct value of e is found to be 45.4. The result of our calculation, i.e., the distribution of thermodynamic variables for different values of x for $e = 45.4$ is shown in table 2.1.

Table 2.1

The distribution of temperature, mass, density and pressure in a protoplanet for

$$e = 45.4$$

Non dimensional distance x	Non dimensional pressure p	Non dimensional mass q	Non dimensional temperature t
.99	0	1	.0040
.9	.0188	3.86×10^{-1}	.0443
.8	.0135	9.25×10^{-1}	.0976
.7	.4625	8.09×10^{-1}	.1597
.6	1.1384	6.47×10^{-1}	.2289
.5	2.2778	4.61×10^{-1}	.3021
.4	3.8981	2.81×10^{-1}	.3746
.3	5.8448	1.36×10^{-1}	.4404
.2	7.7747	4.51×10^{-2}	.4937
.1	9.2576	6.58×10^{-3}	.5294
.01	10.8939	6.57×10^{-4}	.5650
.001	25.9424	6.50×10^{-4}	.7998

ii) Solution for the conductive-radiative case

For this case we have to solve the equations (2.15), (2.16) and (2.19).

Introducing the same variable $\xi = \frac{1}{x} - 1$ in equations (2.15) and (2.16), we have

$$\frac{dp}{d\xi} = \frac{pq}{t}, \quad (2.33)$$

$$\frac{dq}{d\xi} = -\frac{p}{t(1+\xi)^4} \quad (2.34)$$

respectively that we have already derived.

Similarly from (2.19), we get

$$\frac{dt}{d\xi} = C\gamma \frac{pq}{\alpha t^4 + \beta p} (1+\xi). \quad (2.35)$$

To obtain starting values for our variables for integrations from surface inwards, we assume a series solution satisfying the boundary conditions, which are valid for small values of ξ in the following form:

$$p = \xi^u (a_0 + a_1\xi + a_2\xi^2 + \dots), \quad (2.36)$$

$$q = 1 \quad (2.37)$$

and
$$t = \xi^v (c_0 + c_1\xi + c_2\xi^2 + \dots). \quad (2.38)$$

Using (2.36), (2.37) and (2.38) in (2.33), we have

$$\{a_0 u \xi^{u-1} + a_1 (u+1) \xi^u + a_2 (u+2) \xi^{u+1} + \dots\} \times \\ \xi^v (c_0 + c_1 \xi + c_2 \xi^2 + \dots) = \xi^u (a_0 + a_1 \xi + a_2 \xi^2 + \dots)$$

or

$$\xi^{v-1} \xi^u \{a_0 u + a_1 (u+1) \xi + a_2 (u+2) \xi^2 + \dots\} \times \\ (c_0 + c_1 \xi + c_2 \xi^2 + \dots) = \xi^u (a_0 + a_1 \xi + a_2 \xi^2 + \dots)$$

To exist a solution,

$$v = 1 \quad (2.39)$$

and then,
$$u a_0 c_0 = a_0$$

or
$$u c_0 = 1. \quad (2.40)$$

Therefore, from (2.38) with the help of (2.39), we get

$$t = c_0 \xi + c_1 \xi^2 + c_2 \xi^3 + \dots \quad (2.41)$$

Again using (2.36), (2.37) and (2.41) in (2.35), we get

$$\{\alpha(c_0\xi + c_1\xi^2 + c_2\xi^3 + \dots)^4 + \beta\xi^u(a_0 + a_1\xi + a_2\xi^2 + \dots)\} \times \\ (c_0 + 2c_1\xi + \dots) = C\gamma(1 + \xi)\xi^u(a_0 + a_1\xi + a_2\xi^2 + \dots)$$

or

$$\alpha(c_0\xi + c_1\xi^2 + \dots)^4(c_0 + 2c_1\xi + \dots) \\ = C\gamma(1 + \xi)\xi^u(a_0 + a_1\xi + a_2\xi^2 + \dots) \\ - \beta\xi^u(a_0 + a_1\xi + a_2\xi^2 + \dots)(c_0 + 2c_1\xi + \dots)$$

To exist a solution,

$$u = 4, \quad (2.42)$$

$$\alpha c_0^5 = C\gamma a_0 - a_0 c_0 \beta, \quad (2.43)$$

etc.

From (2.40) and (2.42), we get

$$c_0 = \frac{1}{4} = .25. \quad (2.44)$$

From (2.43), we get

$$a_0 = \frac{\alpha c_0^5}{C\gamma - c_0 \beta}. \quad (2.45)$$

The series (2.36) and (2.38) are convergent for small values of ξ .

Therefore considering only first term, we have

$$p = a_0 \xi^4, \text{ and } t = .25\xi,$$

where

$$a_0 = \frac{8.5759 \times 10^3 \times (.25)^5}{1.4333 \times 10^4 C - .25 \times 7.4768 \times 10^{-5}} \\ \approx \frac{8.5759 \times 10^3 \times (.25)^5}{1.4333 \times 10^4 C} \\ = \frac{5.84309 \times 10^{-4}}{C}.$$

We will solve equations (2.33), (2.34) and (2.35) with the help of the 4th order Runge-Kutta method using the boundary conditions given by $p = a_0 \xi^4$, $q = 1$ and $t = .25\xi$. In general it is found that these equations hold good accuracy from the surface inwards for some values of ξ near to zero.

Putting $\xi = \frac{y}{y-1}$ in (2.33) and (2.34), we get

$$\frac{dp}{dy} = \frac{pq}{t(1-y)^2}, \quad (2.46)$$

and
$$\frac{dq}{dy} = -\frac{p(1-y)^2}{t} \quad (2.47)$$

respectively that we have already shown in (2.30).

Similarly from (2.35), we get

$$\frac{dt}{dy} = C \frac{\gamma pq^2}{(1-y)^3(\alpha t^4 + \beta p)}. \quad (2.48)$$

We have solved equations (2.46), (2.47) and (2.48) by the 4th order Runge-Kutta method to obtain the distribution of p , q and t . Since the values of ξ are very close to zero, so the values of y will be very close to zero. If we take $y = .01$, then at that point

$$t = \left(\frac{.25y}{1-y} \right)_{y=.01} = \frac{.25 \times .01}{1-.01} = 2.5253 \times 10^{-3},$$

$$q = 1 \text{ and } p = \frac{5.84309 \times 10^{-4}}{C} \left(\frac{.01}{1-.01} \right)^4 = \frac{6.084 \times 10^{-12}}{C}.$$

But $C \left(= \frac{dR}{dt} \right)$ is not known. The initial value of the radius is $R = 3 \times 10^{12}$ cm and the present age of the planetary system is about 4.5 billion years. If we assume that a protoplanet takes about billion years to reach its present state, then $C \sim 10^{-4}$. We consider a number of trial values of C around 10^{-4} . The correct value of C will be for which the extra boundary condition, i.e., $q \rightarrow 0$ as $r \rightarrow 0$ is satisfied. The values we have adapted are $C = 3.6 \times 10^{-4}$, 3.65×10^{-4} , 3.9×10^{-4} . We have solved equations (2.46), (2.47) and (2.48) for these values of C numerically again by the 4th order Runge-Kutta method from the same starting point $y = .01$ inwards

for the distribution of masses. Eliminating y in terms of x we have obtained the solutions of the equations (2.46), (2.47) and (2.48) for those values of C . The results are shown graphically in figure 2.2.

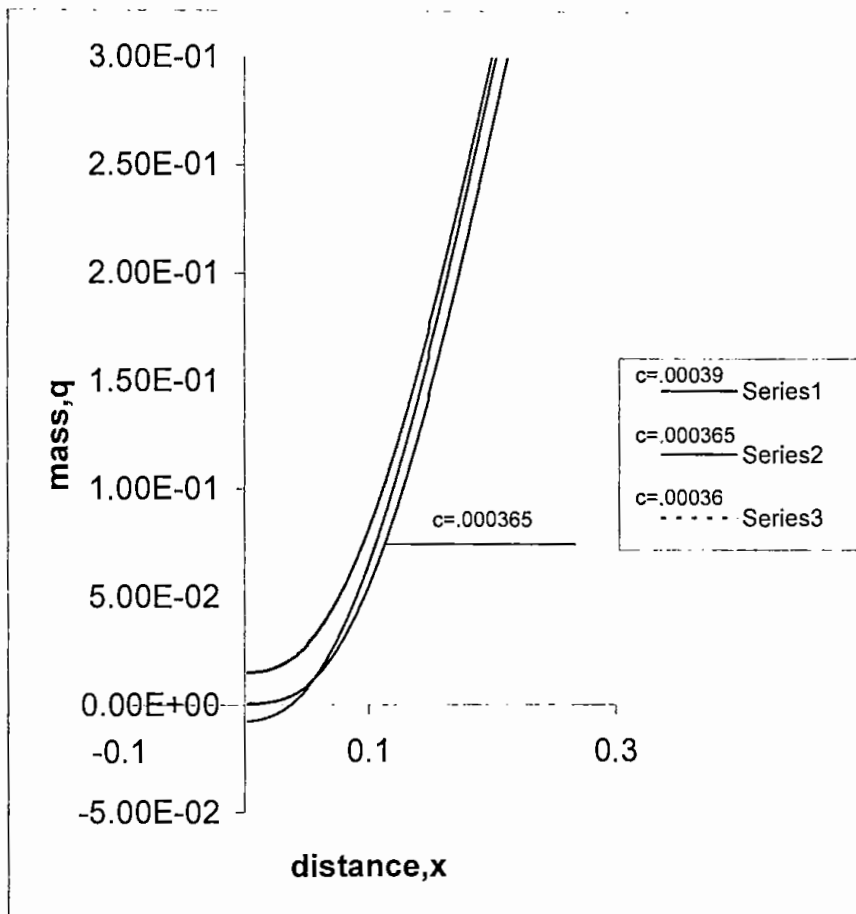

Fig. 2.2: mass distribution in protoplanet when it is in conductive-radiative equilibrium.

It is found that the correct value of C is 3.65×10^{-4} . The result of our calculation, i.e., the distribution of thermodynamic variables for different values of x for $C = 3.65 \times 10^{-4}$ is shown in table 2.2.

Table 2.2

The distribution of temperature, mass, density and pressure in a protoplanet for

$$C = 3.65 \times 10^{-4}$$

Non dimensional distance x	Non dimensional pressure p	Non dimensional mass q	Non dimensional temperature t
.9	.0002	9.998×10^{-1}	.0281
.8	.0057	9.927×10^{-1}	.0639
.7	.0459	9.852×10^{-1}	.1104
.6	.2418	9.513×10^{-1}	.1719
.5	1.0334	8.770×10^{-1}	.2537
.4	3.9078	7.408×10^{-1}	.3607
.3	13.4780	5.296×10^{-1}	.4938
.2	41.5973	2.680×10^{-1}	.6382
.1	103.7624	5.492×10^{-2}	.7440
.01	167.9955	7.678×10^{-4}	.7661

3. Summary and discussion

Following stellar evolutionary code we have determined the structure of a protoplanet of given mass and radius by numerical method under approximate zero boundary conditions. The protoplanet has been assumed to be a sphere of solar composition, which is in a steady state of quasi-static equilibrium. It is also assumed that the only source of energy in a protoplanet is gravitational. Regarding the heat transference of heat inside the protoplanet we have considered two cases of interest, the convective case and the conductive-radiative case. For the

convective case the structure is found to be dependent on a parameter e . However, the best solution satisfying the boundary conditions at both the centre and the surface is obtained for $e = 45.4$. This value of e is similar to the value of E obtained by Osterbrock (1953) in determining structure of a convective star. For the conductive-radiative case the solution depends on the rate of contraction. The correct solution satisfying the boundary conditions at both ends is obtained for $C = 3.65 \times 10^{-4}$ which implies a contraction time of about three billion years. This is much in excess of the Helmholtz-Kelvin contraction time (e.g., Schwarzschild, 1958) for the Sun. This is expected because the protoplanet has been assumed in a quasi-static state. However, in both cases the system possesses unique solution. The distribution of the thermodynamic variables in both cases is quite reasonable.

4. References

- Bohm-Vitense, E., 1997. *Introduction to Stellar Astrophysics Volume 3*,
Cambridge University Press.
- McCrea, W. H., 1960. *Proc. Roy. Soc.*, A, 256, 245.
- McCrea, W. H. and Williams, I. P., 1965. *Proc. Roy. Soc.*, A, 287, 143.
- Osterbrock, D. E., 1953. *Ap. J.*, 118, 529.
- Schwarzschild, M., 1958. *Structure and Evolution of the Stars*, Princeton
University Press.
- Schwarzschild, M., 1946. *Ap. J.*, 104, 203.

Chapter-3

Structure of a protoplanet : Polytropic method

1. Polytropes

A quasi-static change in which the specific heat remains constant is called a polytropic change. Thus a polytropic change with specific heat c is characterized by the relation (e.g., Menzel et al. 1963)

$$\frac{dQ}{dT} = c. \quad (3.1)$$

When $c = 0$, $\frac{dQ}{dT} = 0$, we have adiabatic change and when $c = \infty$, $\frac{dQ}{dT} = \infty$, we have isothermal change. Thus a polytropic change is intermediate between an adiabatic change and an isothermal change.

From the 1st law of thermodynamics, we have

$$dQ = dU + PdV, \quad (3.2)$$

where dU and dV are the changes in internal energy and in volume of a gas respectively, P is the pressure and dQ is the amount of heat added.

Equation (3.2) can be written as

$$dQ = \frac{dU}{dT} dT + PdV. \quad (3.3)$$

But for a perfect gas, we have

$$PV = \mathfrak{R}T, \quad (3.4)$$

where \mathfrak{R} is the molar gas constant.

Also,
$$\frac{dU}{dT} = c_v. \quad (3.5)$$

Hence from equation (3.3) with the help of equations (3.4) and (3.5), we have

$$dQ = c_v dT + \frac{\Re T}{V} dV.$$

But
$$\Re = c_p - c_v.$$

Therefore,

$$dQ = c_v dT + (c_p - c_v) \frac{T}{V} dV. \quad (3.6)$$

For a polytropic change, we have

$$dQ = cdT. \quad (3.7)$$

Substituting the value of dQ from equation (3.7) in equation (3.6), we have

$$cdT = c_v dT + (c_p - c_v) T \frac{dV}{V}$$

or
$$(c_v - c)dT + (c_p - c_v) T \frac{dV}{V} = 0$$

or
$$\frac{dT}{T} + \frac{c_p - c_v}{c_v - c} \frac{dV}{V} = 0$$

or
$$\frac{dT}{T} + \frac{1}{n} \frac{dV}{V} = 0, \quad (3.8)$$

where $n = \frac{c_v - c}{c_p - c_v}$ is called the polytropic index.

Taking logarithm on both sides of equation (3.4), we get

$$\log P + \log V = \log T + \log \Re.$$

Taking differentials on both sides, we get

$$\frac{dP}{P} + \frac{dV}{V} = \frac{dT}{T}$$

or
$$\frac{dP}{P} + \frac{dV}{V} = -\frac{1}{n} \frac{dV}{V}, \text{ using (3.8)}$$

or
$$\frac{dP}{P} + \left(1 + \frac{1}{n}\right) \frac{dV}{V} = 0.$$

In terms of density the above equation can be written as

$$\frac{dP}{P} = \left(1 + \frac{1}{n}\right) \frac{d\rho}{\rho}.$$

Integrating, we get

$$P = K\rho^{1+\frac{1}{n}},$$

where K is called polytropic constant.

This gives the density distribution in a polytrope.

2. Lane-Emden equation

We assume that a star is in hydrostatic equilibrium under its own gravitation. Consider the equilibrium of an infinitesimal cylinder of mass δm , of unit cross-section and thickness δr , placed with its base normal to the radius vector at distance r from the centre. The difference of pressure δp , acting on either face of the cylinder, is balanced by the inward gravitational attraction of the mass $M(r)$ interior to r , so that

$$dP = -\frac{GM(r)\rho dr}{r^2}$$

or
$$\frac{dP}{dr} = -\frac{GM(r)\rho(r)}{r^2}, \quad (3.9)$$

where G is the universal gravitational constant.

This is the hydrostatic equation.

Furthermore, if $\rho(r)$ is the density at any distance r from the centre, then

$$M(r) = \int_0^r 4\pi r^2 \rho(r) dr \quad (3.10)$$

or
$$dM(r) = 4\pi r^2 \rho(r) dr . \quad (3.11)$$

Equation (3.9) can be written as

$$\frac{r^2}{\rho} \frac{dP}{dr} = -GM(r)$$

or
$$\frac{r^2}{\rho} \frac{dP}{dr} = -G \int_0^r 4\pi r^2 \rho dr , \text{ using (3.10)}$$

or
$$\frac{d}{dr} \left(\frac{r^2}{\rho} \frac{dP}{dr} \right) = -4\pi G r^2 \rho , \text{ using (3.11)}$$

or
$$\frac{1}{r^2} \frac{d}{dr} \left(\frac{r^2}{\rho} \frac{dP}{dr} \right) = -4\pi G \rho(r) . \quad (3.12)$$

This is the fundamental equation of equilibrium.

Now for a complete polytrope,

$$\rho(r) = \rho_c \theta^n , \quad (3.13)$$

where ρ_c is the central density.

From the polytropic law,

$$P = K \rho^{1+\frac{1}{n}} \quad (3.14)$$

or
$$P = K \left(\rho_c \theta^n \right)^{1+\frac{1}{n}} , \text{ using (3.13)}$$

or
$$P = K \rho_c^{1+\frac{1}{n}} \theta^{n+1} \quad (3.15)$$

or
$$\frac{dP}{dr} = K \rho_c^{1+\frac{1}{n}} (1+n) \theta^n \frac{d\theta}{dr} . \quad (3.16)$$

Now from equation (3.12) with the help of equations (3.13) and (3.16), we get

$$\frac{1}{r^2} \frac{d}{dr} \left(\frac{r^2}{\rho_c \theta^n} K \rho_c^{1+\frac{1}{n}} (1+n) \theta^n \frac{d\theta}{dr} \right) = -4\pi G \rho_c \theta^n$$

or

$$\left[\frac{(n+1)K \rho_c^{\frac{1}{n}+1}}{\rho_c} \right] \frac{1}{r^2} \frac{d}{dr} \left(r^2 \frac{d\theta}{dr} \right) = -4\pi G \rho_c \theta^n$$

or

$$\left[\frac{(n+1)K}{4\pi G} \rho_c^{\frac{1}{n}-1} \right] \frac{1}{r^2} \frac{d}{dr} \left(r^2 \frac{d\theta}{dr} \right) = -\theta^n. \quad (3.17)$$

If we define $r = \alpha \xi$, where

$$\alpha = \left[\frac{(n+1)K}{4\pi G} \rho_c^{\frac{1}{n}-1} \right]^{\frac{1}{2}}, \quad (3.18)$$

then from equation (3.17), we have

$$\alpha^2 \frac{1}{\alpha^2 \xi^2} \frac{1}{\alpha} \frac{d}{d\xi} \left(\alpha^2 \xi^2 \frac{1}{\alpha} \frac{d\theta}{d\xi} \right) = -\theta^n$$

or

$$\frac{1}{\xi^2} \frac{d}{d\xi} \left(\xi^2 \frac{d\theta}{d\xi} \right) = -\theta^n. \quad (3.19)$$

This is Lane-Emden equation of index n .

From (3.13), we have

$$\theta = 1 \text{ at } \xi = 0 \text{ (centre)}. \quad (3.20)$$

We rewrite equation (3.19) in the following form:

$$\xi \frac{d^2\theta}{d\xi^2} + 2 \frac{d\theta}{d\xi} + \xi \theta^n = 0. \quad (3.21)$$

We find that

$$\frac{d\theta}{d\xi} = 0 \text{ at } \xi = 0. \quad (3.22)$$

Thus under the boundary conditions (3.20) and (3.22), the differential equation (3.19) will possess a unique solution. This solution is denoted by θ_n and is given by (e.g., Chandrasekhar 1939)

$$\theta_n = 1 - \frac{1}{6}\xi^2 + \frac{n}{120}\xi^4 - \dots, \quad (3.23)$$

which satisfies both the boundary conditions at $\xi = 0$.

3. Physical characteristic of a polytrope

i) Radius: The radius of a polytrope is given by

$$R = \left[\frac{(n+1)K}{4\pi G} \right]^{\frac{1}{2}} \rho_c^{\frac{1-n}{2n}} \xi_1, \quad (3.24)$$

where ξ_1 is the first zero of θ_n . On the basis of numerical integration of (3.19) we can say that when $0 < n < 5$, θ_n monotonically decreases as ξ increases and attains the zero value for a finite value ξ_1 of ξ . In these cases the model has a finite radius. When $n \geq 5$, θ_n attains zero value only when $\xi \rightarrow \infty$, so that these polytropes have infinite radius. Evidently these polytropes, having infinite extension, do not represent any stars. Therefore we shall consider the values of n lying between 0 and 5.

ii) Mass: The mass $M(\xi)$ within the radius $r = \alpha\xi$ is given by

$$M(\xi) = \int_0^{\alpha\xi} 4\pi r^2 \rho dr = 4\pi\alpha^3 \rho_c \int_0^{\xi} \xi^2 \theta^n d\xi \text{ as } \rho = \rho_c \theta^n$$

or
$$M(\xi) = -4\pi\alpha\rho_c \int_0^{\xi} \frac{d}{d\xi} \left(\xi^2 \frac{d\theta}{d\xi} \right) d\xi, \text{ using (3.19)}$$

or
$$M(\xi) = 4\pi\alpha^3 \rho_c \left[-\xi^2 \frac{d\theta}{d\xi} \right] \quad (3.25)$$

or

$$M = 4\pi\alpha^3\rho_c \left[-\xi^2 \frac{d\theta}{d\xi} \right]_{\xi=\xi_1}$$

or

$$M = 4\pi \left[\frac{(n+1)K}{4\pi G} \right]^{3/2} \rho_c^{3-n} \left[-\xi^2 \frac{d\theta}{d\xi} \right]_{\xi=\xi_1}, \text{ using (3.18).} \quad (3.26)$$

iv) Central condensation: The mean density $\overline{\rho(\xi)}$ within ξ is given by

$$\overline{\rho(\xi)} = \frac{M(\xi)}{\frac{4\pi}{3}(\alpha\xi)^3}. \quad (3.27)$$

Substituting for $M(\xi)$ from (3.25), we get

$$\overline{\rho(\xi)} = -\frac{3}{\xi} \rho_c \frac{d\theta}{d\xi}. \quad (3.28)$$

Therefore, the central condensation, which is the ratio of central density to mean density

$$\frac{\rho_c}{\overline{\rho}} = \left[-\frac{\xi}{3} \frac{1}{\left(\frac{d\theta}{d\xi} \right)} \right]_{\xi=\xi_1} \quad (3.29)$$

or

$$\rho_c = a_n \overline{\rho},$$

where

$$a_n = \left[-\frac{\xi}{3} \frac{1}{\left(\frac{d\theta}{d\xi} \right)} \right]_{\xi=\xi_1}$$

or

$$\rho_c = a_n \frac{3M}{4\pi R^3}. \quad (3.30)$$

v) The central pressure: From the polytropic law the central pressure is given by

$$P_c = K\rho_c^{1+\frac{1}{n}}. \quad (3.31)$$

Eliminating ρ_c between equations (3.24) and (3.26), we get the mass-radius relation as

$$M^{\frac{n-1}{n}} R^{\frac{3-n}{n}} = \frac{(n+1)K}{G(4\pi)^{\frac{1}{n}}} \omega_n^{\frac{n-1}{n}}, \quad (3.32)$$

where

$$\omega_n = -\xi_1^{\frac{n+1}{n-1}} \left(\frac{d\theta}{d\xi} \right)_{\xi_1}.$$

Substituting K from (3.32) and ρ_c from (3.30) in (3.31), we have

$$P_c = \frac{GM^{\frac{n-1}{n}} R^{\frac{3-n}{n}} (4\pi)^{\frac{1}{n}}}{(n+1)\omega_n^{\frac{n-1}{n}}} \left(a_n \frac{3M}{4\pi R^3} \right)^{1+\frac{1}{n}}$$

or

$$P_c = b_n \frac{M^2 G}{R^4}, \quad (3.33)$$

where

$$b_n = \frac{1}{4\pi(n+1) \left(\frac{d\theta}{d\xi} \right)_{\xi=\xi_1}^2}. \quad (3.34)$$

vi) The central temperature: One of the equations governing the hydrostatic equilibrium is

$$P = \frac{k}{\mu H} \rho T \quad (\text{no radiation pressure}). \quad (3.35)$$

From (3.35) and (3.14), we get

$$T = \frac{\mu H}{k} K \rho^{\frac{1}{n}}. \quad (3.36)$$

If μ is constant throughout the model, the central temperature is given by

$$T_c = \frac{\mu H}{k} K \rho_c^{1/n}. \quad (3.37)$$

Substituting K from (3.31) in (3.37), we can write

$$T_c = \frac{\mu H}{k} \frac{P_c}{\rho_c}. \quad (3.38)$$

Using (3.30) and (3.33) in (3.38), we get

$$T_c = c_n \frac{GM}{R}; \quad (3.39)$$

where

$$c_n = \frac{4\pi\mu H}{3k} \frac{b_n}{\alpha_n}. \quad (3.40)$$

4. Application to protoplanets

Model equations

We consider a protoplanet whose mass and radius, as suggested by several authors (e.g., McCrea 1960, McCrea and Williams 1965), are given by $M = 2 \times 10^{30}$ gm and $R = 3 \times 10^{12}$ cm respectively. We assume that the protoplanet is in a state of quasi-static equilibrium in which ideal gas laws hold. We also assume that the polytropic law gives the density distribution in the protoplanet. The structure of the protoplanet is then given by the following set of equations:

i) The equation of hydrostatic equilibrium,

$$\frac{dP_r}{dr} = -\frac{GM_r}{r^2} \rho_r. \quad (3.41)$$

ii) The equation of conservation of mass,

$$\frac{dM_r}{dr} = 4\pi r^2 \rho_r. \quad (3.42)$$

iii) The equation of state,

$$P_r = \frac{\mathfrak{R}}{\mu} \rho_r T_r. \quad (3.43)$$

iv) The equation of polytropic law,

$$P_r = K \rho_r^{1+1/n}. \quad (3.44)$$

Here G is the universal gravitational constant, \mathfrak{R} the gas constant, μ the mean molecular weight, K the polytropic constant and n is the polytropic index while P_r , T_r and ρ_r give the pressure, the temperature and the density at distance r from the center. M_r denotes the mass inside radius r . We now have four equations in four unknowns. We can solve these equations by using the central boundary conditions:

$P = P_c$, $\rho = \rho_c$, $T = T_c$ and $M_r = 0$ at $r = 0$, where

$$\rho_c = a_n \frac{3M}{4\pi R^3}, \quad (3.45)$$

$$P_c = b_n \frac{GM^2}{R^4} \quad (3.46)$$

and
$$T_c = c_n \frac{GM}{R}, \quad (3.47)$$

the values of the constants a_n and b_n being available in the table (e.g., Chandrasekhar 1939). The values of c_n are obtained by using equation (3.40).

Calculation and results

If we introduce the dimensionless variables

$$\theta = \left(\frac{\rho}{\rho_c} \right)^{1/n} \quad (3.48)$$

and
$$x = \frac{r}{R}, \quad (3.49)$$

then from equation (3.17), we get

$$\left[\frac{(n+1)K}{4\pi G} \rho_c^{\frac{1}{n}-1} \right] \frac{1}{x^2 R^2} \frac{1}{R} \frac{d}{dx} \left(x^2 R^2 \frac{1}{R} \frac{d\theta}{dx} \right) = -\theta^n$$

or
$$\frac{1}{x^2} \frac{d}{dx} \left(x^2 \frac{d\theta}{dx} \right) = - \frac{R^2}{\frac{(n+1)K}{4\pi G} \rho_c^{\frac{1}{n}-1}} \theta^n$$

or
$$\frac{1}{x^2} \frac{d}{dx} \left(x^2 \frac{d\theta}{dx} \right) = -\xi_1^2 \theta^n, \quad (3.50)$$

where ξ_1 is the Lane - Emden radius and is given by

$$\xi_1 = \frac{R}{\left[\frac{(n+1)K}{4\pi G} \rho_c^{\frac{1}{n}-1} \right]^{\frac{1}{2}}}. \quad (3.51)$$

Again for a complete polytrope

$$P_c = K \rho_c^{1+\frac{1}{n}}. \quad (3.52)$$

From equations (3.14) and (3.52), we get

$$\frac{P}{P_c} = \frac{K \rho^{1+\frac{1}{n}}}{K \rho_c^{1+\frac{1}{n}}} = \left(\frac{\rho}{\rho_c} \right)^{1+\frac{1}{n}}. \quad (3.53)$$

or
$$\left(\frac{P}{P_c} \right)^{\frac{1}{n+1}} = \left(\frac{\rho}{\rho_c} \right)^{\frac{1}{n}}. \quad (3.54)$$

From equations (3.36) and (3.37), we get

$$\frac{T}{T_c} = \left(\frac{\rho}{\rho_c} \right)^{\frac{1}{n}}. \quad (3.55)$$

Therefore, from equations (3.13), (3.54) and (3.55), we have

$$\theta = \left(\frac{\rho}{\rho_c} \right)^{\frac{1}{n}} = \left(\frac{P}{P_c} \right)^{\frac{1}{1+n}} = \frac{T}{T_c}. \quad (3.56)$$

That means θ straightway determines the distribution of ρ , P and T . So we have to find θ by solving (3.50) for the distribution of ρ , P and T . Necessary boundary conditions for solving (3.50) are

$$\theta = 1, \quad \frac{d\theta}{dx} = 0 \quad \text{at } x = 0.$$

Equation (3.50) as such cannot be integrated analytically for all values of n . Resort has to be taken to numerical technique. But because of the singularity at $x = 0$ the integration cannot be started right from the center. However, near the singular point, the equation has a series solution of the form (from equation (3.23):

$$\theta = 1 - \frac{x^2 \xi_1^2}{6} + \frac{n \xi_1^4 x^4}{120} - \dots, \quad (3.57)$$

which converges for small x . With the help of this equation we can now start the integration for a given value of n , from a point, very close to the center.

We take $n = \frac{3}{2}$. Then $\xi_1 = 3.65375$.

Therefore, using the equation (3.40), we get

$$c_n = \frac{4 \times 3.14159 \times .6 \times 1.67352 \times 10^{-24} \cdot .77014}{3 \times 1.38062 \times 10^{-16} \cdot 5.99071} \\ = 3.9164 \times 10^{-9}.$$

Also with the prescribed values of M and R we find from equations (3.45), (3.46) and (3.47),

$$\rho_c = 5.9907 \times \frac{3 \times 2 \times 10^{30}}{4 \times 3.14159 \times (3 \times 10^{12})^3} \\ = 1.05939 \times 10^{-7},$$

$$P_c = .77014 \times \frac{6.675 \times 10^{-8} \times (2 \times 10^{30})^2}{(3 \times 10^{12})^4}$$

$$= 2538.6096$$

and

$$T_c = 3.9164 \times 10^{-9} \times \frac{6.675 \times 10^{-8} \times 2 \times 10^{30}}{3 \times 10^{12}}$$

$$= 174.2798$$

in c.g.s. units respectively. For some values of n , ξ_1 , c_n , ρ_c , P_c and T_c are shown in table 3.1.

Table 3.1

Some important quantities for the polytrope for some values of the polytropic index n

n	ξ_1	c_n	ρ_c	P_c	T_c
.5	2.7528	3.1717×10^{-9}	3.2469×10^{-8}	630.1249	141.1407
1	3.14159	3.6364×10^{-9}	5.8178×10^{-8}	1294.4523	161.8198
1.5	3.65375	3.9164×10^{-9}	1.0594×10^{-7}	2538.6096	174.2798
3	6.89685	6.2133×10^{-9}	9.5816×10^{-7}	36426.2496	276.4919

Now, at some $x = 10^{-5}$ (say) the equation (3.57) gives

$$\theta_0 = 1 - 2.22498 \times 10^{-10} = .99999 \text{ and}$$

$$\left(\frac{d\theta}{dx}\right)_0 = -\frac{10^{-5} \times (3.65375)^2}{3} = -4.44996 \times 10^{-5}, \text{ neglecting}$$

x^3 and higher powers of x .

With these values as our initial conditions, we have solved equation (3.50) numerically by the fourth order Runge-Kutta method to determine θ and $\frac{d\theta}{dx}$ for different x . These are given in table 3.2.

Table-3.2

Some important quantities for the polytrope for some values of x of the polytropic index $n = 1.5$

x	θ	$\frac{d\theta}{dx}$	$-x^2 \frac{d\theta}{dx}$
.1	.9780	-.4362	.0044
.2	.9144	-.8218	.0329
.3	.8166	-1.1166	.1005
.4	.6449	-1.2988	.2078
.5	.5607	-1.3661	.3415
.6	.4250	-1.3333	.4800
.7	.2966	-1.2258	.6006
.8	.1814	-1.0731	.6868
.9	.0825	-.9035	.7318
1	0	-.7421	.7421

The corresponding values of ρ , P and T have also been calculated from equation (3.56). There remains the problem of determining the mass distribution.

Now with the help of (3.48) and (3.49), equation (3.42) becomes

$$\frac{dM(x)}{dx} = 4\pi x^2 R^3 \rho_c \theta^n$$

or
$$M(x) = 4\pi R^3 \rho_c \int_0^x x^2 \theta^n dx \quad (3.58)$$

or
$$M(x) = -4\pi R^3 \rho_c \int_0^x \frac{1}{\xi^2} \frac{d}{d\xi} \left(x^2 \frac{d\theta}{dx} \right) dx, \text{ using (3.50)} \quad (3.59)$$

or
$$M(x) = \frac{4\pi R^3 \rho_c}{\xi_1^2} \left(-x^2 \frac{d\theta}{dx} \right). \quad (3.60)$$

Inserting the parameters involved, we get

$$M(x) = \frac{4 \times 3.14159 \times (3 \times 10^{12})^3 \times 1.05939 \times 10^{-7}}{(3.65375)^2} \left(-x^2 \frac{d\theta}{dx}\right)$$

$$= 2.69247 \times 10^{30} \left(-x^2 \frac{d\theta}{dx}\right). \quad (3.61)$$

Inserting $\frac{d\theta}{dx}$ from the table (3.2) we have calculated $M(x)$ for different x from the relation (3.61). Table 3.3 gives the structure of a polytropic protoplanet for $n = \frac{3}{2}$.

Table 3.3

The distribution of temperature, mass, density and pressure of a protoplanet of polytropic index $n = 1.5$

Non dimensional distance	Temperature	Mass	Density	Pressure
0.1	170.4456	1.18×10^{28}	1.025×10^{-07}	2401.0051
0.2	159.3614	8.85×10^{28}	9.264×10^{-08}	2029.9593
0.3	142.3169	2.71×10^{29}	7.818×10^{-08}	1529.9584
0.4	112.3930	5.60×10^{29}	6.137×10^{-08}	1021.8664
0.5	97.7187	9.20×10^{29}	4.448×10^{-08}	597.6960
0.6	74.0689	1.29×10^{30}	2.935×10^{-08}	298.9647
0.7	51.6914	1.62×10^{30}	1.711×10^{-08}	121.5928
0.8	31.6144	1.85×10^{30}	8.183×10^{-09}	35.5658
0.9	14.3781	1.97×10^{30}	2.511×10^{-09}	4.9648
1	0	2.00×10^{30}	4.98×10^{-14}	0

However, the appropriate value of n for a protoplanet is not known. We have therefore, run the program for some different values of n , namely $n = 0.5$, $n = 1$, $n = \frac{3}{2}$ and $n = 3$. These results are shown graphically in the diagrams 3.1-3.4.

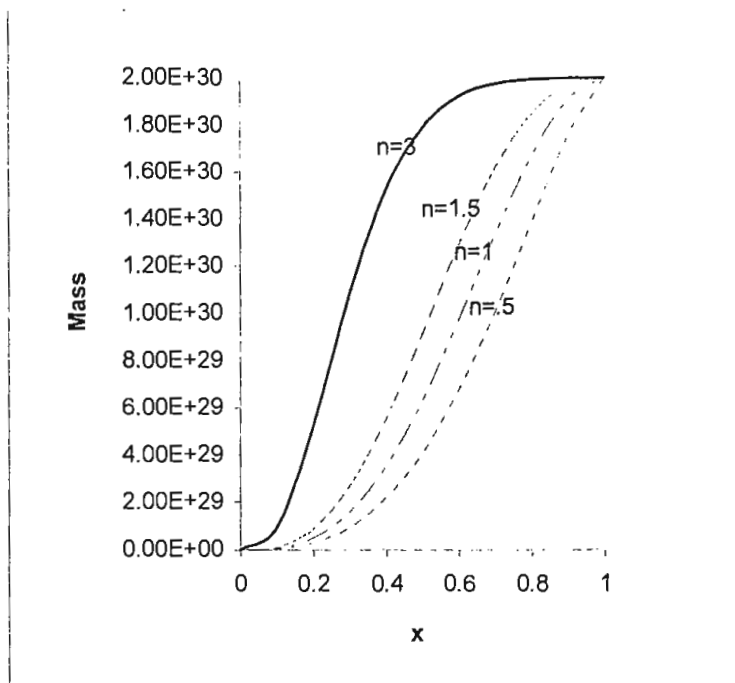

Fig. 3.1: Mass distribution in a protoplanet.

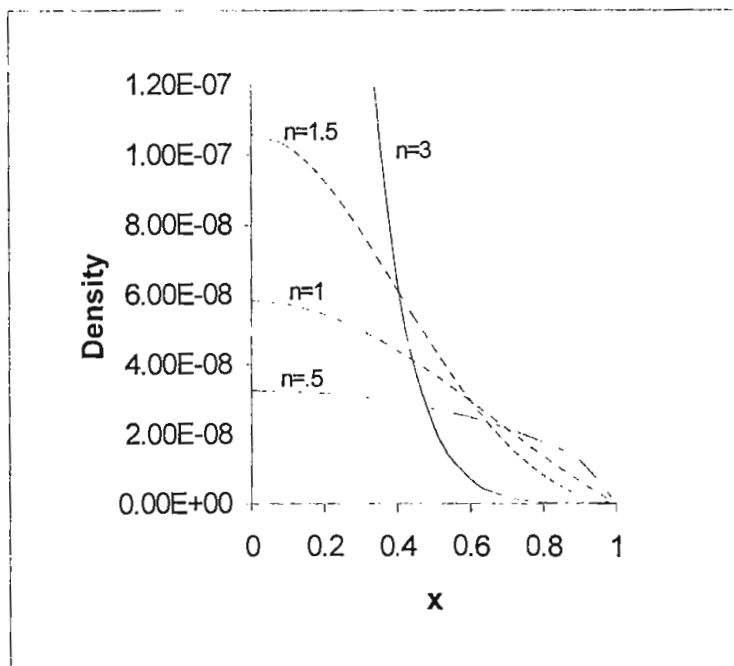

Fig. 3.2: Density distribution in a protoplanet.

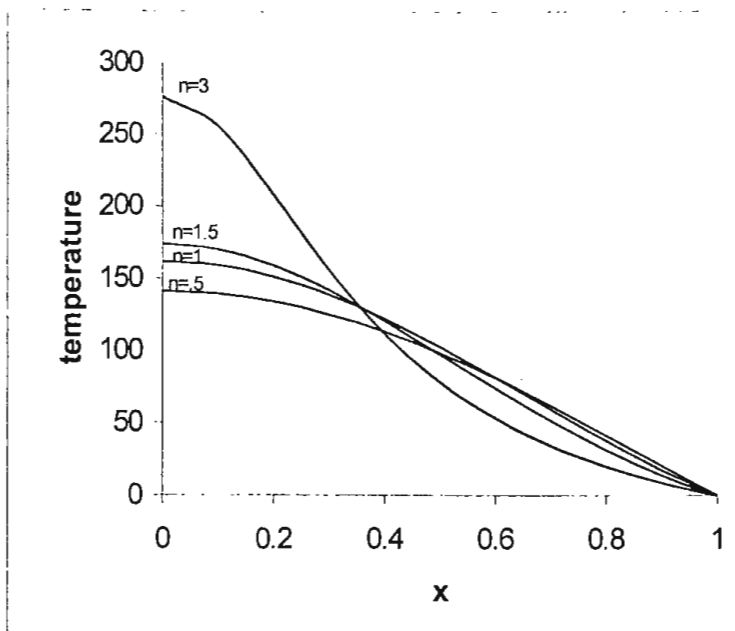

Fig. 3.3: Temperature distribution in a protoplanet

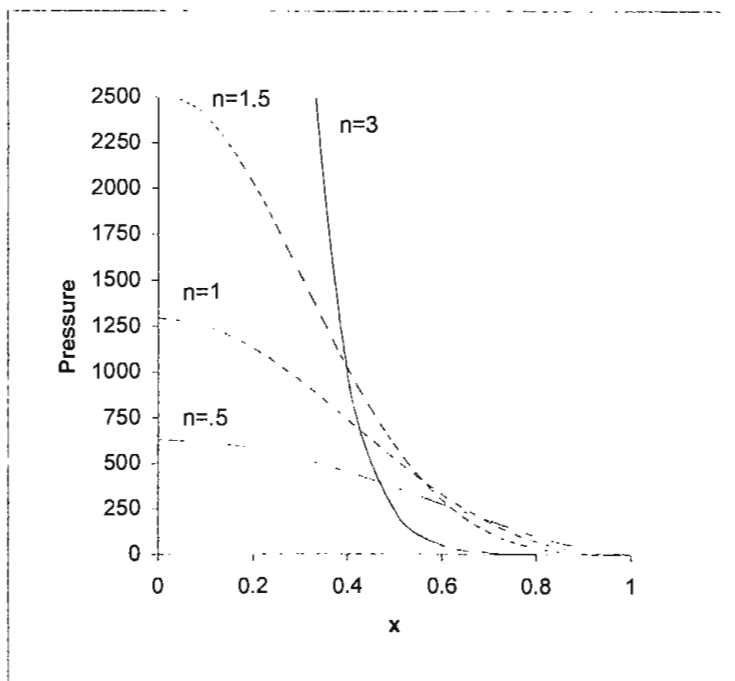

Fig. 3.4: Pressure distribution in a protoplanet.

5. Discussion

We have determined the distribution of the thermodynamic variables in a protoplanet by polytropic method assuming that the protoplanet is a polytrope of index $n = .5, 1, \frac{3}{2}$ and 3. It is found that for all n the system possesses unique solution. However for $n=3$ the protoplanet is found to be highly centrally condensed as is expected. In this case the protoplanet has a large envelope, most of the mass being concentrated in a small volume near the centre. This is a highly unlikely situation. Because if the protoplanets formed out of the solar nebula much before segregation of heavy elements on to the rotation plane might occur, then the protoplanets could not become so much centrally condensed unless they have contracted to planetary dimensions. But this is contrary to our hypothesis. On the other hand if shock wave is the trigger for fragmentation of the nebula then the initial protoplanets are likely be convective. For convection $n = \frac{3}{2}$. It is seen from the diagrams that, for $n = \frac{3}{2}$, the protoplanet has a small envelope, and the distribution of the thermodynamic variables is quite reasonable. This is so for $n=1$ also while for $n=0.5$, the distributions are flatter almost like a constant density model. It is therefore reasonable to conclude that the protoplanets having density distribution given by $n=1$ and $n = \frac{3}{2}$ are closer to reality. The structures of such protoplanets have been shown in the diagrams.

6. References

- Chandrasekhar, S., 1939. *An introduction to the study of Stellar Structure*, The University of Chicago Press.
- McCrea, W. H., 1960. *Proc. Roy. Soc.*, A, 256, 245.
- Mccrea, W. H. and Williams, I. P., 1965. *Proc. Roy. Soc.*, A, 287, 143.
- Menzel, D. M; Bhatnagar, P. L. and Sen, H. S., 1963. *Stellar Interiors*, Chapman and Hall Ltd., London.

Chapter-4

Segregation of heavy elements in a protoplanet

1. Introduction

Any known raw material that could have featured in the formation of the planetary system must have had a similar chemical composition to that of the Sun or to normal interstellar material. The formation of the Earth and other terrestrial planets therefore requires the removal of the greater part of the hydrogen and helium from some body. There are two obvious alternatives, either the segregation of the material can occur prior to the agglomeration into protoplanets (e.g., Mizuno 1980, Pollack 1984, Pollack et al.1996) or the agglomeration can occur first followed by a segregation process which now occurs in a body that has roughly the dimensions of a major planet (e.g., Boss 2000, 20001, 20002, 20003, Nelson et al. 2000, Rich et al. 2003). According to this model, the protoplanetary disk becomes gravitationally unstable. In the first instance segregation occurs before agglomeration into protoplanets usually through the dust grains settling onto the plane of the nebula, which then accumulate into protoplanets in this plane. The obvious differences in composition between the planets occurs primarily as the consequence of a temperature gradient away from the Sun allowing only the non-volatile material to aggregate near to the Sun, but allowing the gases to aggregate further out. In the second type of theory these two processes of segregation and accumulation occur in the reverse order. Large protoplanets composed of both gas and dust and formed first, if necessary from an accumulation of the captured discrete objects. Segregation followed by the removal of the gaseous component is therefore necessary in order to produce an object similar to the terrestrial plants. Advocates of this type of theory point out that this leads to one very satisfactory point, it allows all the protoplanets to be

identical to one another before segregation occurs, therefore requiring only one type of mechanism for forming protoplanets. The obvious mechanism for segregation is that the dust grains present in the protoplanets, being heavier than the gas, will settle towards the centre of the protoplanet under the gravitational field of the protoplanet. This segregation process was first investigated by McCrea and Williams (1965) who concluded that normal interstellar dust grains could not possibly settle to the centre in the time available for such a process. They showed however that if grains adhered together on collision then the segregation timescale became reasonably short. This process was also investigated, using numerical techniques, by Williams and Crampin (1971) who concluded that the segregation time found by McCrea and Williams were essentially correct. For simplicity, both McCrea and Williams and Williams and Crampin assumed that the density remained constant throughout the protoplanet. This is a considerable assumption since virtually every known astronomical object is centrally condensed, this being necessary in order to have hydrostatic support. Further, the three main effects which influence the segregation rate, namely the gravitational field, the resistance to the motion of the grain, and the rate of growth of the grain, are all functions of the density. It is therefore far from clear that results obtained by either of the two previous investigation give anything approximating to the correct answer for the segregation time in a real globe. Williams and Handbury (1974) analyzed the segregation problem for a centrally condensed protoplanet. They conclude that the time fall of a grain differ only by a numerical factor of order unity from that of McCrea and Williams (1965). It is, therefore, clear that in some way the increased resistance is compensated by the increased gravitational field. Williams and Handbury, however, considered an arbitrary chosen density model for central condensation of the globe without any physics behind that. In this thesis we intend to investigate the same problem without going into any density model. In chapter-2 we have calculated the distribution of mass and density in the interior of a protoplanet. Using these calculated values of mass and density we attempt to determine the time of fall of a grain in a protoplanet.

2. The model used

We consider a spherical globe of material of mass M and radius R . The globe in reality is a protoplanet which either develops directly into a planet similar to Jupiter or in which segregation takes place and in which only the core develops into a terrestrial planet. The globe consists mainly of hydrogen and helium but with a proportion λ by weight of heavy elements, mostly in the form of grains. Let a grain start moving from rest at the surface towards the centre through the ambient gas. The gas offers resistance to the motion of the grains. Then the equation of motion of the grain at depth x below the surface is given by the simple form

$$\frac{d}{dt} \left(m_g \frac{dx}{dt} \right) = \frac{GM(x)m_g}{(R-x)^2} - F_{res}, \quad (4.1)$$

where m_g is the mass of the grain, G the gravitational constant, R the radius of the protoplanet, F_{res} the resistive force and $M(x)$ is the mass interior to a radius $R-x$ (i.e., at depth x).

Different expressions for F_{res} exist in the literature for different cases. If the grain is small, then the resistance is given by expression found in Baines and Williams (1965) as

$$F_{res} = \frac{4}{3} \pi \rho W r_g^2 \frac{dx}{dt}, \quad (4.2)$$

where ρ is the density of the gas in the protoplanet, W the mean thermal velocity and r_g is the radius of the grain.

If the grain is larger, then the resistance is given by the usual Stokes's formula

$$F_{res} = 6\pi\eta r_g \frac{dx}{dt}, \quad (4.3)$$

where η is the coefficient of kinematic viscosity.

In our calculation we assume two cases of interest:

- i) the grain mass is constant and
- ii) the grain mass is variable due to accretion.

Expressions (i) and (ii) will be considered for F_{res} in the respective cases. In numerical work we shall adopt the values $\lambda = 10^{-2}$, $M = 2 \times 10^{30}$ gm (total mass of a protoplanet) and $R = 3 \times 10^{12}$ cm.

Calculation of segregation time

i) grain mass constant

For normal interstellar grains the radius is small, being of the order of $\approx 10^{-5}$ cm. Hence if the grain mass is constant, the equation (4.2) is applicable. The equation of motion (4.1) then reduces to

$$m_g \frac{d^2 x}{dt^2} = \frac{GM(x)m_g}{(R-x)^2} - \frac{4}{3} \pi \rho W r_g^2 \frac{dx}{dt}. \quad (4.4)$$

Both experiment and solutions of simpler equations of motion tell us that in general any body reaches a velocity close to its terminal velocity quickly and then proceeds to travel at such a velocity. We shall assume that this is the case for the falling grain under discussion. With this simplification, the equation of motion (4.4) becomes

$$\frac{GM(x)m_g}{(R-x)^2} - \frac{4}{3} \pi \rho W r_g^2 \frac{dx}{dt} = 0$$

or

$$\frac{dx}{dt} = \frac{3GM(x)m_g}{4\pi\rho W r_g^2 (R-x)^2}. \quad (4.5)$$

The mass of the grain m_g is given by

$$m_g = \frac{4}{3} \pi r_g^3 \rho_g, \quad (4.6)$$

where ρ_g is the mass density of the grain, which is assumed to be constant throughout.

Again, the mean thermal velocity W is given by

$$W = \sqrt{\frac{8kT}{\pi H}}, \quad (4.7)$$

where H is the mass of a hydrogen atom, T the temperature and k the Boltzmann constant.

Substituting m_g from (4.6) and W from (4.7) in equation (4.5), we get

$$\frac{dx}{dt} = \frac{3GM(x) \times \frac{4}{3} \pi r_g^3 \rho_g}{4\pi \rho_g^2 (R-x)^2 \times \sqrt{\frac{8kT}{\pi H}}}$$

or

$$\frac{dx}{dt} = \frac{\sqrt{(\pi H)GM(x)} r_g \rho_g}{\sqrt{(8kT)} \rho (R-x)^2}. \quad (4.8)$$

We introduce the dimensionless variables defined by

$$T(x) = \frac{\mu HGM}{kR} \theta,$$

$$P(x) = \frac{GM^2}{4\pi R^4} p,$$

$$M(x) = qM,$$

$$x = \xi R$$

and

$$t = 10^7 \tau,$$

where the symbol μ represents mean molecular weight of the standard composition.

From the equation of state of an ideal gas, we have

$$\rho = \frac{\mu P}{\Re T}.$$

In terms of dimensionless variables this becomes

$$\rho = \frac{\mu}{\mathfrak{R}} \frac{\frac{GM^2}{4\pi R^4} p}{\frac{\mu HGM}{kR} \theta}$$

or
$$\rho = \frac{M}{4\pi R^3} \frac{p}{\theta}, \text{ as } k = \mathfrak{R}H.$$

Then from equation (4.8), we get

$$\frac{R}{10^7} \frac{d\xi}{d\tau} = \frac{\sqrt{(\pi H)G} \times qM \times r_g \rho_g}{\sqrt{(8k)} \times \sqrt{\frac{\mu HGM}{kR} \theta} \times \frac{M}{4\pi R^3} \frac{p}{\theta} \times (R - R\xi)^2}$$

or
$$\frac{d\xi}{d\tau} = 10^7 r_g \rho_g \sqrt{\frac{2\pi^3 GR}{\mu M}} \frac{q\sqrt{\theta}}{p(1-\xi)^2}$$

or
$$\frac{d\xi}{d\tau} = \alpha \frac{q\sqrt{\theta}}{p(1-\xi)^2}, \quad (4.9)$$

where
$$\alpha = 10^7 r_g \rho_g \sqrt{\frac{2\pi^3 GR}{\mu M}}. \quad (4.10)$$

From (4.6), we get

$$r_g^3 = \frac{3m_g}{4\pi\rho_g}$$

or
$$r_g = \sqrt[3]{\frac{3m_g}{4\pi\rho_g}}. \quad (4.11)$$

With $m_g = 2 \times 10^{-13}$ gm and $\rho_g = 1$ gm cm⁻³ from (4.11), we get

$$r_g = \sqrt[3]{\frac{3 \times 2 \times 10^{-13}}{4\pi\rho_g}} = 3.6278 \times 10^{-5} \text{ cm.}$$

With the prescribed values of M and R with $G = 6.675 \times 10^{-8}$ dyne cm² gm⁻²

and $r_g = 3.6278 \times 10^{-5}$ cm, we get from (4.10)

$$\alpha = 10^7 \times 3.6278 \times 10^{-5} \times 1 \times \sqrt{\frac{2 \times (3.14159)^3 \times 6.675 \times 10^{-8} \times 3 \times 10^{12}}{.6 \times 2 \times 10^{30}}}$$

$$= 1.167 \times 10^{-9}.$$

With these values the equation (4.9) becomes

$$\frac{d\xi}{d\tau} = 1.167 \times 10^{-9} \frac{q\sqrt{\theta}}{p(1-\xi)^2}$$

or

$$d\tau = \frac{1}{1.167 \times 10^{-9}} \frac{p(1-\xi)^2}{q\sqrt{\theta}} d\xi.$$

The time of fall of a grain of constant mass from the surface to the centre is given by

$$\tau = \int_0^1 F(\xi, p, q, \theta) d\xi, \quad (4.12)$$

where

$$F(\xi, p, q, \theta) = \frac{1}{1.167 \times 10^{-9}} \frac{p(1-\xi)^2}{q\sqrt{\theta}}, \quad (4.13)$$

p , q and θ being functions of ξ .

The integral, as such, can not be evaluated analytically. Resort has to be taken to numerical techniques. Again, because of the singularity the integration can not be started right from the surface. However, from a point very near to the surface the integration can easily be started. This is possible because p and θ admit series solutions near the point $\xi = 0$, as mentioned before. To integrate (4.12) numerically we had to know $F(\xi, p, q, \theta)$ at each step. In chapter 2 we have calculated the values of p , q and θ for different values of ξ for two different cases of interest, namely, (i) the protoplanet is in convective equilibrium and (ii) the protoplanet is in conductive- radiative equilibrium. For the convective case with the calculated values of p , q and θ at different ξ we have calculated $F(\xi, p, q, \theta)$ at these ξ 's. All these data are shown in table 4.1.

Table 4.1: The values of p , q , θ and $F(\xi)$ for different values of ξ in the convective model

ξ	p	q	θ	$F(\xi, p, q, \theta)$
0.01	0	1.00E+00	0.004	0.00E+00
0.02	0	1.00E+00	0.008	0.00E+00
0.03	0.001	9.99E-01	0.012	7.37E+06
0.039	0.002	9.99E-01	0.016	1.25E+07
0.049	0.003	9.98E-01	0.021	1.61E+07
0.059	0.004	9.96E-01	0.025	1.93E+07
0.069	0.007	9.95E-01	0.03	3.02E+07
0.079	0.009	9.93E-01	0.034	3.57E+07
0.088	0.013	9.90E-01	0.039	4.74E+07
0.098	0.017	9.87E-01	0.043	5.79E+07
0.108	0.022	9.84E-01	0.048	6.96E+07
0.118	0.028	9.80E-01	0.053	8.27E+07
0.128	0.035	9.76E-01	0.058	9.70E+07
0.137	0.044	9.71E-01	0.063	1.15E+08
0.147	0.053	9.66E-01	0.068	1.31E+08
0.157	0.064	9.60E-01	0.074	1.49E+08
0.167	0.076	9.53E-01	0.079	1.69E+08
0.177	0.09	9.47E-01	0.084	1.90E+08
0.186	0.106	9.39E-01	0.09	2.14E+08
0.196	0.123	9.31E-01	0.095	2.37E+08
0.206	0.142	9.23E-01	0.101	2.62E+08
0.216	0.163	9.14E-01	0.107	2.87E+08
0.226	0.187	9.05E-01	0.113	3.16E+08
0.235	0.212	8.95E-01	0.119	3.44E+08
0.245	0.24	8.84E-01	0.125	3.75E+08
0.255	0.271	8.73E-01	0.131	4.08E+08
0.265	0.304	8.62E-01	0.137	4.41E+08
0.275	0.34	8.50E-01	0.143	4.76E+08
0.284	0.379	8.37E-01	0.15	5.14E+08
0.294	0.421	8.24E-01	0.156	5.52E+08
0.304	0.466	8.11E-01	0.163	5.91E+08
0.314	0.515	7.97E-01	0.169	6.34E+08
0.324	0.567	7.83E-01	0.176	6.76E+08
0.333	0.623	7.68E-01	0.183	7.23E+08
0.343	0.683	7.53E-01	0.19	7.70E+08
0.353	0.747	7.38E-01	0.196	8.20E+08
0.363	0.814	7.22E-01	0.203	8.70E+08
0.373	0.886	7.06E-01	0.21	9.23E+08
0.382	0.962	6.89E-01	0.217	9.81E+08
0.392	1.043	6.73E-01	0.225	1.03E+09

ξ	p	q	θ	$F(\xi, p, q, \theta)$
0.402	1.128	6.56E-01	0.232	1.09E+09
0.412	1.218	6.39E-01	0.239	1.16E+09
0.422	1.313	6.21E-01	0.246	1.22E+09
0.431	1.412	6.04E-01	0.253	1.29E+09
0.441	1.517	5.86E-01	0.261	1.36E+09
0.451	1.626	5.68E-01	0.268	1.43E+09
0.461	1.741	5.50E-01	0.276	1.50E+09
0.471	1.86	5.32E-01	0.283	1.58E+09
0.48	1.985	5.14E-01	0.29	1.66E+09
0.49	2.115	4.96E-01	0.298	1.74E+09
0.5	2.251	4.78E-01	0.305	1.83E+09
0.51	2.392	4.60E-01	0.313	1.91E+09
0.52	2.537	4.42E-01	0.32	2.00E+09
0.529	2.689	4.24E-01	0.328	2.11E+09
0.539	2.845	4.06E-01	0.335	2.20E+09
0.549	3.007	3.89E-01	0.343	2.30E+09
0.559	3.173	3.71E-01	0.35	2.41E+09
0.569	3.345	3.54E-01	0.358	2.51E+09
0.578	3.522	3.37E-01	0.365	2.64E+09
0.588	3.704	3.21E-01	0.373	2.75E+09
0.598	3.89	3.04E-01	0.38	2.87E+09
0.608	4.081	2.88E-01	0.388	3.00E+09
0.618	4.277	2.72E-01	0.395	3.13E+09
0.627	4.477	2.57E-01	0.402	3.28E+09
0.637	4.681	2.42E-01	0.409	3.42E+09
0.647	4.889	2.28E-01	0.417	3.55E+09
0.657	5.101	2.14E-01	0.424	3.69E+09
0.667	5.317	2.00E-01	0.431	3.85E+09
0.676	5.536	1.87E-01	0.438	4.02E+09
0.686	5.758	1.74E-01	0.445	4.19E+09
0.696	5.984	1.62E-01	0.452	4.35E+09
0.706	6.213	1.50E-01	0.458	4.53E+09
0.716	6.444	1.39E-01	0.465	4.70E+09
0.725	6.678	1.28E-01	0.472	4.92E+09
0.735	6.915	1.18E-01	0.478	5.10E+09
0.745	7.154	1.08E-01	0.485	5.30E+09
0.755	7.395	9.89E-02	0.492	5.48E+09
0.765	7.639	9.03E-02	0.498	5.67E+09
0.774	7.885	8.23E-02	0.504	5.91E+09
0.784	8.134	7.47E-02	0.511	6.09E+09
0.794	8.386	6.77E-02	0.517	6.26E+09
0.804	8.642	6.12E-02	0.523	6.43E+09
0.814	8.902	5.53E-02	0.529	6.56E+09
0.823	9.167	4.98E-02	0.536	6.75E+09
0.833	9.438	4.48E-02	0.542	6.84E+09
0.843	9.717	4.03E-02	0.548	6.88E+09

ξ	p	q	θ	$F(\xi, p, q, \theta)$
0.853	10.007	3.62E-02	0.555	6.87E+09
0.863	10.309	3.26E-02	0.561	6.79E+09
0.872	10.63	2.94E-02	0.568	6.74E+09
0.882	10.974	2.66E-02	0.576	6.49E+09
0.892	11.351	2.42E-02	0.583	6.14E+09
0.902	11.772	2.22E-02	0.592	5.67E+09
0.912	12.255	2.05E-02	0.602	5.11E+09
0.921	12.829	1.91E-02	0.613	4.59E+09
0.931	13.541	1.79E-02	0.626	3.90E+09
0.941	14.47	1.70E-02	0.643	3.17E+09
0.951	15.77	1.64E-02	0.665	2.43E+09
0.961	17.773	1.59E-02	0.698	1.74E+09
0.97	21.331	1.56E-02	0.751	1.22E+09
0.98	29.469	1.54E-02	0.855	7.09E+08
0.99	63.197	1.53E-02	1.161	3.28E+08

In our previous estimation we have taken $\xi = .01$ as the starting point and integrated the equations of structure down to the point $\xi = .99$. Because of singularity we have excluded the points $\xi = 0$ and $\xi = 1$. In the present case we also take the same step length within the same limit. Equation (4.12) then becomes

$$\tau = \int_{.01}^{.99} F(\xi, p, q, \theta) d\xi, \quad (4.14)$$

Now by Simpson's one- third rule

$$\int_{x_0}^{x_n} y dx = \frac{h}{3} [(y_0 + y_n) + 4(y_1 + y_3 + \dots + y_{n-1}) + 2(y_2 + y_4 + \dots + y_{n-2})],$$

where the step length $h = \frac{x_n - x_0}{n}$, n the number of divisions, y_0 the value of y at x_0 , y_1 the value of y at $x_0 + h$, y_2 the value of y at $x_0 + 2h$, etc.

In our calculation

$$\tau = \frac{h}{3} \left[(F_{.01} + F_{.99}) + 4 \times (F_{.02} + F_{.039} \dots \dots \dots + F_{.98}) + \right. \\ \left. 2 \times (F_{.03} + F_{.049} + \dots \dots \dots + F_{.97}) \right],$$

where h is the step length defined by $h = \frac{x_n - x_0}{n}$, where $x_n = .99$, $x_0 = .01$ and

$n = 100$ and hence $h = \frac{.99 - .01}{100} = 9.8 \times 10^{-3}$. Taking $F(\xi, p, q, \theta)$ from table 4.1

and $h = 9.8 \times 10^{-3}$, we have

$$\begin{aligned} \tau &= \frac{9.8 \times 10^{-3}}{3} \times [(0 + 3.28 \times 10^8) + \\ &4 \times (0 + 1.25 \times 10^7 + \dots + 7.09 \times 10^8) \\ &+ 2 \times (7.37 \times 10^6 + 1.61 \times 10^7 + \dots + 1.00 \times 10^9)] \end{aligned}$$

or

$$\begin{aligned} \tau &= \frac{9.8 \times 10^{-3}}{3} (3.28 \times 10^8 + 4.78 \times 10^{11} + 2.38 \times 10^{11}) \\ &= \frac{9.8 \times 10^{-3}}{3} \times 7.16328 \times 10^{11} \\ &= 2.34 \times 10^9 . \end{aligned}$$

Since τ is units of 10^7 , this is, therefore, the time required to fall to the centre

$$\begin{aligned} t &= 2.34 \times 10^9 \times 10^7 \\ &= 2.34 \times 10^{16} \text{ seconds} \\ &\approx 2.34 \times 10^9 \text{ years.} \end{aligned}$$

In the conductive-radiative case using the same step length we find as in chapter 2 the values of p , q and θ and hence of $F(\xi, p, q, \theta)$ at different ξ . All these values are given in table 4.2.

Table 4.2: The values of p , q , θ and $F(\xi)$ for different values of ξ in the conductive-radiative model

ξ	p	q	θ	$F(\xi, p, q, \theta)$
.01	2.00E-08	1.00E+00	.003	3.07+02
0.02	2E-07	1.00E+00	0.0051	2.30E+03
0.03	1.2E-06	1.00E+00	0.0074	1.12E+04
0.04	3.9E-06	1.00E+00	0.01	3.08E+04
0.05	1.02E-05	1.00E+00	0.0127	7.00E+04
0.06	2.22E-05	1.00E+00	0.0154	1.35E+05
0.07	4.31E-05	1.00E+00	0.0183	2.36E+05
0.08	0.000077	1.00E+00	0.0212	3.84E+05
0.09	0.000129	1.00E+00	0.0241	5.89E+05
0.1	0.000205	1.00E+00	0.0272	8.64E+05
0.11	0.000314	1.00E+00	0.0303	1.22E+06
0.12	0.000464	1.00E+00	0.0335	1.68E+06
0.13	0.000667	1.00E+00	0.0367	2.26E+06
0.14	0.000937	9.99E-01	0.0401	2.97E+06
0.15	0.001288	9.99E-01	0.0435	3.83E+06
0.16	0.001741	9.99E-01	0.047	4.86E+06
0.17	0.002317	9.99E-01	0.0506	6.09E+06
0.18	0.003042	9.98E-01	0.0543	7.53E+06
0.19	0.003945	9.98E-01	0.0581	9.22E+06
0.2	0.005061	9.98E-01	0.062	1.12E+07
0.21	0.006431	9.97E-01	0.0659	1.34E+07
0.22	0.0081	9.96E-01	0.07	1.60E+07
0.23	0.010123	9.96E-01	0.0742	1.90E+07
0.24	0.012559	9.95E-01	0.0785	2.23E+07
0.25	0.01548	9.94E-01	0.083	2.61E+07
0.26	0.018966	9.93E-01	0.0875	3.03E+07
0.26	0.023109	9.91E-01	0.0922	3.60E+07
0.27	0.028015	9.90E-01	0.097	4.15E+07
0.28	0.033804	9.88E-01	0.1019	4.76E+07
0.29	0.040613	9.87E-01	0.107	5.44E+07
0.3	0.048597	9.85E-01	0.1122	6.19E+07
0.31	0.057936	9.83E-01	0.1175	7.02E+07
0.32	0.068829	9.80E-01	0.123	7.93E+07
0.33	0.081508	9.77E-01	0.1287	8.94E+07
0.34	0.096231	9.75E-01	0.1345	1.00E+08
0.35	0.113295	9.71E-01	0.1405	1.13E+08
0.36	0.133034	9.68E-01	0.1466	1.26E+08
0.37	0.155826	9.64E-01	0.1529	1.41E+08
0.38	0.182102	9.60E-01	0.1594	1.56E+08
0.39	0.212345	9.56E-01	0.1661	1.74E+08

ξ	p	q	θ	$F(\xi, p, q, \theta)$
0.4	0.247105	9.51E-01	0.173	1.93E+08
0.41	0.287001	9.46E-01	0.1801	2.13E+08
0.42	0.332733	9.40E-01	0.1873	2.36E+08
0.43	0.385091	9.34E-01	0.1948	2.60E+08
0.44	0.444966	9.28E-01	0.2025	2.86E+08
0.45	0.513361	9.21E-01	0.2104	3.15E+08
0.46	0.591408	9.13E-01	0.2185	3.46E+08
0.47	0.680379	9.05E-01	0.2269	3.80E+08
0.48	0.781708	8.97E-01	0.2355	4.16E+08
0.49	0.897005	8.88E-01	0.2443	4.56E+08
0.5	1.028079	8.78E-01	0.2534	4.98E+08
0.51	1.176962	8.68E-01	0.2627	5.45E+08
0.52	1.345934	8.57E-01	0.2723	5.94E+08
0.53	1.53755	8.45E-01	0.2821	6.48E+08
0.54	1.75467	8.33E-01	0.2922	7.06E+08
0.55	2.000498	8.20E-01	0.3025	7.70E+08
0.56	2.27861	8.07E-01	0.3131	8.37E+08
0.57	2.593003	7.93E-01	0.324	9.11E+08
0.58	2.948134	7.78E-01	0.3351	9.90E+08
0.59	3.348963	7.62E-01	0.3465	1.08E+09
0.6	3.801011	7.45E-01	0.3582	1.17E+09
0.61	4.310407	7.28E-01	0.3701	1.27E+09
0.62	4.883944	7.10E-01	0.3823	1.38E+09
0.63	5.529139	6.92E-01	0.3948	1.49E+09
0.64	6.254291	6.72E-01	0.4075	1.62E+09
0.65	7.068542	6.52E-01	0.4204	1.76E+09
0.66	7.981935	6.31E-01	0.4336	1.90E+09
0.67	9.005472	6.10E-01	0.447	2.06E+09
0.68	10.15117	5.87E-01	0.4607	2.23E+09
0.69	11.43209	5.64E-01	0.4745	2.42E+09
0.7	12.8624	5.41E-01	0.4884	2.63E+09
0.71	14.45736	5.17E-01	0.5026	2.84E+09
0.72	16.23334	4.92E-01	0.5168	3.08E+09
0.73	18.20776	4.67E-01	0.5312	3.34E+09
0.74	20.39906	4.41E-01	0.5456	3.63E+09
0.75	22.82655	4.16E-01	0.56	3.93E+09
0.75	25.51025	3.89E-01	0.5745	4.63E+09
0.76	28.47064	3.63E-01	0.5888	5.04E+09
0.77	31.72831	3.37E-01	0.6031	5.50E+09
0.78	35.30356	3.11E-01	0.6172	6.00E+09
0.79	39.21579	2.85E-01	0.631	6.55E+09
0.8	43.4828	2.59E-01	0.6446	7.16E+09
0.81	48.11995	2.34E-01	0.6578	7.85E+09
0.82	53.13906	2.09E-01	0.6705	8.61E+09
0.83	58.54718	1.86E-01	0.6827	9.46E+09
0.84	64.34514	1.63E-01	0.6944	1.04E+10

ξ	p	q	θ	$F(\xi, p, q, \theta)$
0.85	70.52585	1.41E-01	0.7053	1.15E+10
0.86	77.07253	1.20E-01	0.7155	1.27E+10
0.87	83.95674	1.01E-01	0.7249	1.41E+10
0.88	91.1365	8.33E-02	0.7334	1.58E+10
0.89	98.5545	6.72E-02	0.7409	1.77E+10
0.9	106.1369	5.29E-02	0.7474	1.99E+10
0.91	113.7932	4.04E-02	0.7529	2.25E+10
0.92	121.4173	2.98E-02	0.7574	2.57E+10
0.93	128.8925	2.10E-02	0.761	2.96E+10
0.94	136.101	1.40E-02	0.7636	3.42E+10
0.95	142.9456	8.79E-03	0.7656	3.98E+10
0.96	149.3979	5.11E-03	0.7669	4.58E+10
0.97	155.6336	2.78E-03	0.7679	4.93E+10
0.98	162.5544	1.53E-03	0.7686	4.15E+10
0.99	175.5677	1.04E-03	0.7702	1.64E+10

With these values of $F(\xi, p, q, \theta)$ from the table 4.2 we can calculate the falling time by integrating equation (4.14) again by Simpson's one-third rule. Proceeding in the usual manner we have the falling time to be given by

$$\tau = \frac{9.8 \times 10^{-3}}{3} [(F_{.01} + F_{.99}) + 4 \times (F_{.02} + F_{.039} \dots \dots \dots + F_{.98}) + 2 \times (F_{.03} + F_{.049} + \dots \dots \dots + F_{.97})]$$

$$\tau = \frac{9.8 \times 10^{-3}}{3} \times [(3.07 \times 10^2 + 1.64 \times 10^{10}$$

or

$$+ 4 \times (2.30 \times 10^3 + 3.08 \times 10^4 + \dots + 4.15 \times 10^{10}) + 2 \times (1.12 \times 10^4 + 7 \times 10^4 + \dots + 4.93 \times 10^{10})]$$

or

$$\tau = \frac{9.8 \times 10^{-3}}{3} (1.64 \times 10^{10} + 1.03 \times 10^{12} + 4.84 \times 10^{11})$$

$$= \frac{9.8 \times 10^{-3}}{3} \times 1.5304 \times 10^{12}$$

$$= 4.9993 \times 10^9 .$$

Therefore, the estimated time is

$$t = 4.9993 \times 10^9 \times 10^7$$

$$= 4.9993 \times 10^{16} \text{ seconds}$$

$$\approx 4.9 \times 10^9 \text{ years.}$$

This gives the time required to fall from the surface to the centre of the protoplanet, which is in conductive-radiative equilibrium state.

ii) grain mass variable

When the grain mass is variable then the equation of motion (4.1) takes the form

$$m_g \frac{d^2 x}{dt^2} + \frac{dx}{dt} \frac{dm_g}{dt} = \frac{GM(x)m_g}{(R-x)^2} - F_{res}. \quad (4.15)$$

If the grain is growing by accretion, soon it will reach a size where the resistance to the motion given by Stokes' formula (4.3) will be applicable.

Then the equation of motion (4.15) becomes

$$m_g \frac{d^2 x}{dt^2} + \frac{dx}{dt} \frac{dm_g}{dt} = \frac{GM(x)m_g}{(R-x)^2} - 6\pi\eta r_g \frac{dx}{dt}. \quad (4.16)$$

Again with the assumption that for most of the time the grain moves with terminal velocity the equation of motion (4.16) becomes

$$\frac{dx}{dt} \frac{dm_g}{dt} = \frac{GM(x)m_g}{(R-x)^2} - 6\pi\eta r_g \frac{dx}{dt}. \quad (4.17)$$

Now, the mass of the grower grain at any time t is given by

$$m_g = \frac{4}{3}\pi [r_g(t)]^3 \rho_g, \quad (4.18)$$

where ρ_g is the density of the grain, which is assumed to be constant throughout.

Substituting m_g from equation (4.18) in equation (4.17), we get

$$\frac{dx}{dt} \frac{d}{dt} \left(\frac{4}{3}\pi r_g^3 \rho_g \right) = \frac{GM(x)}{(R-x)^2} \frac{4}{3}\pi r_g^3 \rho_g - 6\pi\eta r_g \frac{dx}{dt}$$

or

$$4\pi r_g^2 \rho_g \frac{dx}{dt} \frac{dr_g}{dt} = \frac{4\pi G \rho_g}{3} \frac{M(x) r_g^3}{(R-x)^2} - 6\pi\eta r_g \frac{dx}{dt}$$

or

$$4\rho_g \frac{dx}{dt} \frac{dr_g}{dt} = \frac{4G\rho_g}{3} \frac{M(x)r_g}{(R-x)^2} - \frac{6\eta}{r_g} \frac{dx}{dt}. \quad (4.19)$$

The falling grain is postulated to accrete all other grains that collide with it. If we assume that the travel speed of the grain is greater than the mean thermal speed of the grains, then the appropriate equation giving the rate of growth of the grain has been found by Baines and Williams (1965) as

$$\frac{dr_g}{dt} = \frac{\lambda\rho}{4\rho_g} \frac{dx}{dt},$$

where λ is the proportion by weight of the grains adhering to the growing grain.

or

$$\frac{dr_g}{dt} = \beta\rho \frac{dx}{dt}, \quad (4.20)$$

where

$$\beta = \frac{\lambda}{4\rho_g}. \quad (4.21)$$

The radius of the growing grain is given by

$$r_g = r_0 + \beta \int_{.01}^x \rho dx, \quad (4.22)$$

where r_0 is the initial radius of the grain.

Substituting $\frac{dr_g}{dt}$ from (4.20) in equation (4.19), we get

$$4\rho_g \beta\rho \frac{dx}{dt} \frac{dx}{dt} = \frac{4G\rho_g}{3} \frac{M(x)r_g}{(R-x)^2} - \frac{6\eta}{r_g} \frac{dx}{dt}$$

or

$$4\rho_g \beta\rho \left(\frac{dx}{dt}\right)^2 = \frac{4G\rho_g}{3} \frac{M(x)r_g}{(R-x)^2} - \frac{6\eta}{r_g} \frac{dx}{dt}, \quad (4.23)$$

where r_g is given by (4.22).

Let us replace the physical variables x , t and $M(x)$ by the non dimensional variables ξ , τ and q respectively with the help of the following transformations

$$t = 10^7 \tau,$$

$$M(x) = qM,$$

$$x = \xi R$$

and

$$r_g = R_g r_0,$$

where R_g is the non dimensional radius of the grain and is given by

$$R_g = 1 + \beta \int_{.01}^{\xi} \frac{M}{4\pi r_0 R^3} \frac{p}{\theta} d\xi. \quad (4.24)$$

Then equation (4.23) with $\rho = \frac{M}{4\pi R^3} \frac{p}{\theta}$ becomes

$$\begin{aligned} & 4\rho_g \beta \frac{M}{4\pi R^3} \frac{p}{\theta} \frac{R^2}{10^{14}} \left(\frac{d\xi}{d\tau} \right)^2 \\ &= \frac{4G\rho_g}{3} \frac{qMR_g}{(R-\xi R)^2} - \frac{6\eta}{R_g} \frac{R}{10^7} \frac{d\xi}{d\tau} \end{aligned}$$

or

$$\begin{aligned} & 4\rho_g \beta \frac{M}{4\pi R} \frac{p}{\theta} \left(\frac{d\xi}{d\tau} \right)^2 \\ &= \frac{4 \times 10^{14} G\rho_g}{3R^2} \frac{qMR_g}{(1-\xi)^2} - \frac{6 \times 10^7 \eta R}{R_g} \frac{d\xi}{d\tau} \end{aligned}$$

or

$$\frac{p}{\theta} \left(\frac{d\xi}{d\tau} \right)^2 = \frac{4 \times 10^{14} \pi G}{3\beta R} \frac{qR_g}{(1-\xi)^2} - \frac{6 \times 10^7 \pi \eta R^2}{\beta \rho_g M} \frac{1}{R_g} \frac{d\xi}{d\tau}$$

or

$$\frac{p}{\theta} \left(\frac{d\xi}{d\tau} \right)^2 = A \frac{qR_g}{(1-\xi)^2} - B \frac{1}{R_g} \frac{d\xi}{d\tau}, \quad (4.25)$$

where

$$A = \frac{4 \times 10^{14} \pi G}{3\beta R} \quad (4.26)$$

and

$$B = \frac{6 \times 10^7 \pi \eta R^2}{\beta \rho_g M}. \quad (4.27)$$

Equation (4.25) can also be written as

$$\frac{p}{\theta} \left(\frac{d\xi}{d\tau} \right)^2 + B \frac{1}{R_g} \frac{d\xi}{d\tau} - A \frac{qR_g}{(1-\xi)^2} = 0$$

or

$$\frac{d\xi}{d\tau} = -\frac{\frac{B}{R_g}}{2\frac{p}{\theta}} \pm \frac{\sqrt{\left(\frac{B}{R_g}\right)^2 + 4A\frac{p}{\theta} \frac{qR_g}{(1-\xi)^2}}}{2\frac{p}{\theta}}$$

or

$$\frac{d\xi}{d\tau} = -\frac{\frac{B}{R_g}}{2\frac{p}{\theta}} \pm \frac{\frac{1}{R_g} \sqrt{B^2 + 4A\frac{p}{\theta} \frac{qR_g^3}{(1-\xi)^2}}}{2\frac{p}{\theta}}$$

or

$$\frac{d\xi}{d\tau} = -\frac{B\theta}{2R_g p} \pm \frac{\theta \sqrt{B^2 + 4A\frac{R_g^3}{(1-\xi)^2} \frac{pq}{\theta}}}{2R_g p}$$

Taking $\lambda = 10^{-2}$ and $\rho_g = 1 \text{ gm cm}^{-3}$, we have from (4.21)

$$\beta = \frac{10^{-2}}{4 \times 1} = 2.5 \times 10^{-3}.$$

With the prescribed values of M and R we have from (4.26)

$$\begin{aligned} A &= \frac{4 \times 10^{14} \times 3.14159 \times 6.675 \times 10^{-8}}{3 \times 2.5 \times 10^{-3} \times 3 \times 10^{12}} \\ &= 3.728 \times 10^{-3}. \end{aligned}$$

With $\eta = 5.0886 \times 10^{-5} \text{ dyne sec cm}^{-3}$, where η is taken at $100^\circ K$, we have from (4.27)

$$\begin{aligned} B &= \frac{6 \times 10^7 \times 3.14159 \times 5.0886 \times 10^{-5} \times (3 \times 10^{12})^2}{2.5 \times 10^{-3} \times 1 \times 2 \times 10^{30}} \\ &= 17.2652. \end{aligned}$$

Since A and B are positive, and $\frac{d\xi}{d\tau}$ can never be negative, so we take

$$\frac{d\xi}{d\tau} = -\frac{B\theta}{2R_g p} + \frac{\theta \sqrt{B^2 + 4A \frac{R_g^3}{(1-\xi)^2} \frac{pq}{\theta}}}{2R_g p} \quad (4.28)$$

It can be shown that for $0 < \xi < 1$, the right hand side of (4.28) is always positive.

Equation (4.28) can be written as

or

$$\frac{d\xi}{d\tau} = \frac{\theta \sqrt{B^2 + 4A \frac{R_g^3}{(1-\xi)^2} \frac{pq}{\theta}} - B\theta}{2R_g p}$$

or

$$\frac{d\xi}{d\tau} = \frac{B\theta \left[\sqrt{1 + \frac{4A}{B^2} \frac{R_g^3}{(1-\xi)^2} \frac{pq}{\theta}} - 1 \right]}{2R_g p} \quad (4.29)$$

Inserting the values of A and B in equation (4.29), we get

$$\frac{d\xi}{d\tau} = \frac{17.2652\theta \left[\sqrt{1 + 5.0026 \times 10^{-5} \frac{R_g^3}{(1-\xi)^2} \frac{pq}{\theta}} - 1 \right]}{2R_g p}$$

Thus the time of fall of the grain from the surface to the centre is given by

$$\tau = \int_{.01}^{.99} G(\xi, p, q, \theta) d\xi, \quad (4.30)$$

where $G(\xi, p, q, \theta) = \frac{2R_g p}{17.2652\theta \left[\sqrt{\left\{ 1 + 5.0026 \times 10^{-5} \frac{R_g^3}{(1-\xi)^2} \frac{pq}{\theta} \right\}} - 1 \right]}$ (4.31)

Here again this integral can be evaluated for both the convective and conductive-radiative cases. In the convective case, $G(\xi, p, q, \theta)$ have been calculated at different depth using the corresponding values of p , q and θ from chapter 2. These values together with the calculated values of the non-dimensional radius of the grain R_g are shown in table 4.3.

Table 4.3: The values of p , q , θ , R_g and $G(\xi)$ for different values of ξ in the convective model

ξ	R_g	$G(\xi, p, q, \theta)$	ξ	R_g	$G(\xi, p, q, \theta)$
0.01	1	20619.72	0.51	1.000002	10983.28
0.02	1	20205.27	0.52	1.000002	10968.86
0.03	1	19814.85	0.529	1.000002	11009.81
0.039	1	19448.87	0.539	1.000002	11014.96
0.049	1	19065.3	0.549	1.000002	11003.06
0.059	1	18703.95	0.559	1.000002	11031.04
0.069	1	18326.95	0.569	1.000002	11042.5
0.079	1	17971.49	0.578	1.000002	11120.23
0.088	1	17675.4	0.588	1.000002	11127.85
0.098	1	17342.48	0.598	1.000002	11186.73
0.108	1	17011.8	0.608	1.000003	11228.11
0.118	1	16700.42	0.618	1.000003	11289.83
0.128	1	16390.8	0.627	1.000003	11392.43
0.137	1	16136.9	0.637	1.000003	11458.62
0.147	1	15846.72	0.647	1.000003	11501.42
0.157	1	15574.11	0.657	1.000003	11569.48
0.167	1	15318.53	0.667	1.000003	11668.09
0.177	1	15047.72	0.676	1.000003	11813.85
0.186	1	14845.86	0.686	1.000004	11924.9
0.196	1	14607.83	0.696	1.000004	12005.46
0.206	1	14370.23	0.706	1.000004	12126.96
0.216	1	14148.54	0.716	1.000004	12211.6
0.226	1	13927.09	0.725	1.000004	12433.87
0.235	1	13757.14	0.735	1.000004	12524.56
0.245	1	13566.61	0.745	1.000004	12670.99
0.255	1	13376.11	0.755	1.000005	12772.95
0.265	1	13185.62	0.765	1.000005	12870.78
0.275	1	13010.44	0.774	1.000005	13060.95
0.284	1	12886.56	0.784	1.000005	13144.56
0.294	1	12726.84	0.794	1.000005	13191.89
0.304	1	12567.19	0.804	1.000005	13210.66
0.314	1	12423.17	0.814	1.000005	13166.42
0.324	1	12279.38	0.823	1.000006	13239.94
0.333	1	12188.14	0.833	1.000006	13101.71
0.343	1	12061.04	0.843	1.000006	12872.81
0.353	1.000001	11934.49	0.853	1.000006	12563.55
0.363	1.000001	11824.86	0.863	1.000006	12117.68
0.373	1.000001	11716.21	0.872	1.000007	11729.47

ξ	R_g	$G(\xi, p, q, \theta)$	ξ	R_g	$G(\xi, p, q, \theta)$
0.382	1.000001	11663.18	0.882	1.000007	11018.05
0.392	1.000001	11557.23	0.892	1.000007	10145.61
0.402	1.000001	11469.99	0.902	1.000007	9107.051
0.412	1.000001	11384.69	0.912	1.000007	7953.107
0.422	1.000001	11319.69	0.921	1.000008	6880.279
0.431	1.000001	11278.75	0.931	1.000008	5601.861
0.441	1.000001	11220.24	0.941	1.000009	4314.305
0.451	1.000001	11165.43	0.951	1.000009	3086.817
0.461	1.000001	11114.68	0.961	1.00001	2019.794
0.471	1.000001	11068.41	0.97	1.000011	1221.838
0.48	1.000001	11069.6	0.98	1.000014	556.1725
0.49	1.000001	11034.43	0.99	1.000022	151.6861
0.5	1.000001	11005.43			

With these values of $G(\xi, p, q, \theta)$ from the table 4.3 and with the same step length we can calculate the falling time by integrating equation (4.30) again by Simpson's one-third rule. Now by Simpson's one- third rule

$$\tau = \frac{h}{3} \left[(G_{.01} + G_{.99}) + 4 \times (G_{.02} + G_{.039} \dots \dots + G_{.98}) + 2 \times (G_{.03} + G_{.049} + \dots \dots \dots + G_{.97}) \right]$$

$$\tau = \frac{9.8 \times 10^{-3}}{3} \times [(20619.72 + 151.6861) + 4 \times (20205.27 + 19448.87 + \dots + 556.1725) + 2 \times (19814.85 + 19065.3 + \dots + 1221.838)]$$

$$\tau = \frac{9.8 \times 10^{-3}}{3} (20771.4061 + 24698 + 1211238)$$

$$= \frac{9.8 \times 10^{-3}}{3} \times 3.6959 \times 10^6$$

$$= 1.2073 \times 10^4.$$

Therefore, the estimated time is

$$t = 1.2073 \times 10^4 \times 10^7$$

$$= 1.2073 \times 10^{11} \text{ seconds}$$

$$\approx 1.2 \times 10^4 \text{ years.}$$

In the conductive-radiative case using the same step length we find the values of p , q and θ and hence of $G(\xi, p, q, \theta)$ at different ξ . All these values are given in table 4.4.

Table 4.4: The values of p , q , θ , R_g and $G(\xi)$ for different values of ξ in the conductive-radiative model

ξ	R_g	$G(\xi, p, q, \theta)$	ξ	R_g	$G(\xi, p, q, \theta)$
0.01	1	4539.03	0.51	1.000001	1281.746
0.02	1	4447.795	0.52	1.000001	1245.646
0.03	1	4357.487	0.529	1.000001	1215.725
0.039	1	4277.001	0.539	1.000001	1181.604
0.049	1	4188.453	0.549	1.000001	1148.727
0.059	1	4100.831	0.559	1.000002	1116.777
0.069	1	4014.135	0.569	1.000002	1085.867
0.079	1	3928.758	0.578	1.000002	1061.128
0.088	1	3852.35	0.588	1.000002	1032.338
0.098	1	3768.332	0.598	1.000003	1004.525
0.108	1	8554.982	0.608	1.000003	977.8032
0.118	1	6433.957	0.618	1.000003	952.0313
0.128	1	3522.893	0.627	1.000004	932.324
0.137	1	3451.239	0.637	1.000004	908.5827
0.147	1	3372.395	0.647	1.000004	885.9344
0.157	1	3294.447	0.657	1.000005	864.1235
0.167	1	3217.717	0.667	1.000005	843.4524
0.177	1	3141.869	0.676	1.000006	828.9173
0.186	1	3074.761	0.686	1.000007	810.4143
0.196	1	3001.183	0.696	1.000007	792.7785
0.206	1	2928.753	0.706	1.000008	776.226
0.216	1	2857.167	0.716	1.000009	760.8604
0.226	1	2786.984	0.725	1.00001	751.9312
0.235	1	2724.739	0.735	1.000011	738.7788
0.245	1	2656.641	0.745	1.000012	726.9345
0.255	1	2589.602	0.755	1.000013	716.0613
0.265	1	2523.856	0.765	1.000015	706.7526
0.275	1	2459.123	0.774	1.000016	704.7111
0.284	1	2402.09	0.784	1.000018	698.2657

ξ	R_g	$G(\xi, p, q, \theta)$	ξ	R_g	$G(\xi, p, q, \theta)$
0.294	1	2339.726	0.794	1.00002	693.373
0.304	1	2278.305	0.804	1.000022	690.2424
0.314	1	2218.267	0.814	1.000024	688.8824
0.324	1	2159.345	0.823	1.000026	697.079
0.333	1	2107.827	0.833	1.000029	700.7937
0.343	1	2051.189	0.843	1.000031	706.9047
0.353	1	1995.782	0.853	1.000034	715.9604
0.363	1	1941.367	0.863	1.000037	728.682
0.373	1	1888.313	0.872	1.000041	757.1105
0.382	1	1842.335	0.882	1.000044	780.5391
0.392	1	1791.414	0.892	1.000048	810.2084
0.402	1	1741.729	0.902	1.000051	847.5837
0.412	1	1693.235	0.912	1.000055	894.7639
0.422	1	1646.066	0.921	1.000059	978.3426
0.431	1	1605.465	0.931	1.000063	1057.559
0.441	1	1560.406	0.941	1.000067	1155.869
0.451	1	1516.374	0.951	1.000071	1270.266
0.461	1	1473.66	0.961	1.000075	1380.373
0.471	1.000001	1432.054	0.97	1.000079	1493.679
0.48	1.000001	1396.882	0.98	1.000084	1199.438
0.49	1.000001	1357.323	0.99	1.000091	445.2047
0.5	1.000001	1319.059			

With these values of $G(\xi, p, q, \theta)$ from the table 4.4 we can calculate the falling time by integrating equation (4.30) again by Simpson's one-third rule. By Simpson's one-third rule

$$\tau = \frac{h}{3} \left[\begin{array}{l} (G_{.01} + G_{.99}) + \\ 4 \times (G_{.02} + G_{.039} + \dots + G_{.98}) + \\ 2 \times (G_{.03} + G_{.049} + \dots + G_{.97}) \end{array} \right]$$

$$\tau = \frac{9.8 \times 10^{-3}}{3} \times [(4539.03 + 445.2047) +$$

or

$$4 \times (4447.795 + 4188.453 + \dots + 1199.438) \\ + 2 \times (4357.487 + 4100.453 + \dots + 1493.679)]$$

or

$$\tau = \frac{9.8 \times 10^{-3}}{3} (4984.2347 + 373845.3 + 185645.9)$$

$$\begin{aligned}
 &= \frac{9.8 \times 10^{-3}}{3} \times 5.6447 \times 10^5 \\
 &= 1.8439 \times 10^3.
 \end{aligned}$$

Therefore, the estimated time is

$$\begin{aligned}
 t &= 1.8439 \times 10^3 \times 10^7 \\
 &= 1.8439 \times 10^{10} \text{ seconds} \\
 &\approx 1.8 \times 10^3 \text{ years.}
 \end{aligned}$$

3. Summary and conclusion

We have investigated the segregation time for falling grains inside a protoplanet. This is important in forming terrestrial planets from a set of gaseous protoplanets. We have calculated the time for two possible cases of interest, namely, (i) the mass of the grain remains constant during falling, and (ii) the grain mass increases due to its adherence with other grains. In our calculations we have not assumed any density model for solving the problem. We have, rather, determined the density distribution, and hence the mass distribution inside the protoplanet and calculated the time of fall by solving the equation of motion of grain falling under gravity. It is found that for the constant mass model the time of fall of a grain from the surface to the centre is quite long, being of the order of 10^9 years for, whether the protoplanet is in convective equilibrium or in conductive-radiative equilibrium. However, if the grain grows in size by accreting more grains that the time of fall is reasonably short in both cases of convective and conductive-radiative. This time is of the order of a few thousand years. It should be noted that McCrea and Williams (1965) arrived at similar conclusion by assuming the protoplanet to be of uniform density. Their calculated time in this case of variable grain mass is of the order of 10^3 years. In reality the grains are likely to adhere to each other and grow in size. We therefore conclude that a solid core in a protoplanet could form in a reasonable short period of time on astronomical time scale due to gravitational settling. Removal of gaseous envelopes from such protoplanets might produce terrestrial type planets.

4. References

- Baines, M. J. and Williams, I. P., 1965. *Nature* (London), 208, 1191.
- Boss, A. P., 2000. *Astrophys. J.*, 545, L61.
- Boss, A. P., 2001. *Astrophys. J.*, 563, 367.
- Boss, A. P., 2002. *Astrophys. J.*, 576, 462.
- Boss, A. P., 2003. *34th Annual Linear and Planetary Science conference abstract no. 1075.*
- McCrea, W. H. and Williams, I. P., 1965. *Proc. Roy. Soc., A*, 287, 143.
- Mizuno, H., 1980. *Progr. Theor. Phys.*, 64, 544.
- Nelson, A. F.; Benz, W. and Ruzmaikina, T. V., 2000. *Astrophys. J.*, 529, 357.
- Pollack, J. B., 1984. *ARAA*, 22, 389.
- Pollack, J. B.; Hubickyj, o.; Bodenheimer, p.; Lissauer, J. J.; Podolak, M. and Greenzweig, Y., 1996. *Icarus*, 124, 62.
- Rice, W. K. M.; Armitage, P. J.; Bate, M. R. and Bonnell, I. A., 2003. *MNRAS*, 339, 1025.
- Williams, I. P. and Crampin, D. J., 1971. *MNRAS*, 152, 261.
- Williams, I. P. and Handbury, M. J., 1974. *Astrophys. Space Sci.*, 30, 215.

Chapter-5

Orbital evolution of protoplanets with mass loss

1. Introduction

One known feature of the solar system is the planetary distance. The distances are approximately given by the Titius-Bode law, i.e., $r = 0.4 + 0.3 \times 2^n$, where $n = -\infty$ for Mercury, 0 for Venus, 1 for the Earth, 2 for Mars, 4 for Jupiter, 5 for Saturn, 6 for Uranus, 7 for Neptune and 8 for Pluto, and r is in units of 10^{13} cm. Observed distances of the planets do not differ much from the Titius-Bode values. One noticeable feature is that the distance of the outer planets increases with decreasing mass while for the inner planets, smaller the mass, closer is it to the Sun. As far as we know there exists no physical explanation for this distribution of planetary distances. In this thesis we attempt to investigate the problem within the context of the protoplanetary model of planetary formation. In a protoplanetary model mass loss is the mechanism responsible for the variations of the planets that we observe today (e.g., McCrea and Williams 1965, Williams and Handbury 1974, Williams and Crampin 1971, Bhattacharjee and Williams 1978, Donnison and Williams 1977). In this investigation we address ourselves to the question, 'can mass loss from a set of identical protoplanets account for the observed distribution of the planetary distance?'

2. The rate of mass loss

Mass loss in a protoplanet is a complex problem. It can occur as a consequence of many effects, such as solar heating, solar wind bombardment, tidal effects, energy released in core formation etc. No explicit expression for the rate of mass loss

from a protoplanet is available in the literature. Bhattacharjee and Williams (1979) and Bhattacharjee (1983) estimated a mass loss rate from the kinetic theory approach in explaining the distribution of spin angular momentum of the planets and have shown that the amount of angular momentum taken away by the mass lost from a set of identical protoplanets is in excellent accord with observation. In our calculation we adopt this mass loss rate.

For a nonrotating atmosphere whose molecules each of mass m_0 , obey a Maxwellian velocity distribution related to a temperature T , the probability that a molecule has a velocity component in the range u_0 to $u_0 + du_0$ in a prescribed direction is

$$\beta^{\frac{1}{2}} \pi^{-\frac{1}{2}} \exp(-\beta u_0^2) du_0,$$

where $\beta = \frac{m_0}{2kT}$, k being Boltzmann's constant.

Then the mass escaping through an area $d\sigma$ in time dt is given by

$$-nm_0 \beta^{\frac{3}{2}} \pi^{-\frac{3}{2}} \iiint_{w_0 \geq 0, u_0^2 + v_0^2 + w_0^2 \geq v_E^2} w_0 \exp(-\beta(u_0^2 + v_0^2 + w_0^2)) du_0 dv_0 dw_0 ds dt,$$

where n is the number of surface molecules and u_0 , v_0 , w_0 are the components of velocity in three mutually perpendicular directions. w_0 being in the outward normal direction and v_E the escape velocity. For a rotating atmosphere where ds has a velocity V the rate of mass loss in a fixed frame is given by (e.g., Bhattacharjee 1983)

$$\frac{dm}{dt} = -nm_0 \beta^{\frac{3}{2}} \pi^{-\frac{3}{2}} \iiint_{w \geq 0, u^2 + v^2 + w^2 \geq v_E^2} w \exp[-\beta(u^2 + (v-V)^2 + w^2)] du dv dw ds, \quad (5.1)$$

where u , v and w are now the velocity components in the frame fixed in space. For mass loss to occur $\beta v_E^2 < 1$. Evaluation of the integral in (5.1) under this condition gives (Bhattacharjee 1980)

$$\frac{dm}{dt} = -\pi R^2 \rho_s W, \quad (5.2)$$

where W is the mean thermal velocity of the surface molecules. Ignoring any small variation in the temperature and density of the surface molecules, and eliminating R in terms of m we have from (5.2)

$$\frac{dm}{dt} = -cm^{\frac{2}{3}}, \quad (5.3)$$

where c is an unknown constant. If we assume that a protoplanet took about a million years to lose most of its mass then c is found to be $\sim 10^{-3}$. c can be taken as a free parameter. However, since we are interested in determining the effect of mass loss on the protoplanetary orbits, exact value of c is not needed. We take the mass loss rate as

$$\frac{dm}{dt} = -10^{-3} m^{\frac{2}{3}}. \quad (5.4)$$

3. Equation of motion and its solution

i) *Two body problem:*

Let M_\odot be the mass of the Sun with centre at the origin and m denote the mass of a protoplanet at any time which moves in the gravitational field of the Sun suffering mass loss. We assume that both the Sun and protoplanets spherical and that mass loss is spherically symmetric so that this mass can always be considered concentrated at the centre. So Newton's theory is applicable. Since $m \ll M_\odot$, m can be considered to move about the centre of the Sun. If \vec{r} be the distance of the

protoplanet at any time t relative to the Sun, then the equation of motion is given by

$$\frac{d}{dt}(m \dot{\vec{r}}) = -\frac{GmM_{\odot}}{r^3} \vec{r}, \quad (5.5)$$

where G is the gravitational constant.

Equation (5.5) can be written as

$$m \ddot{\vec{r}} + \dot{r} \dot{m} = -\frac{GmM_{\odot}}{r^3} \vec{r}. \quad (5.6)$$

If the coordinates of m be (x, y) , then the equation (5.6) can be written in component form as

$$\left. \begin{aligned} m \frac{d^2 x}{dt^2} + \frac{dm}{dt} \frac{dx}{dt} &= -\frac{GmM_{\odot} x}{r^3} \\ m \frac{d^2 y}{dt^2} + \frac{dm}{dt} \frac{dy}{dt} &= -\frac{GmM_{\odot} y}{r^3} \end{aligned} \right\}$$

where

$$r = (x^2 + y^2)^{\frac{1}{2}}$$

or

$$\left. \begin{aligned} \frac{d^2 x}{dt^2} + \frac{1}{m} \frac{dm}{dt} \frac{dx}{dt} &= -\frac{GM_{\odot} x}{r^3} \\ \frac{d^2 y}{dt^2} + \frac{1}{m} \frac{dm}{dt} \frac{dy}{dt} &= -\frac{GM_{\odot} y}{r^3} \end{aligned} \right\} \quad (5.7)$$

Now,

$$\frac{dm}{dt} = -10^{-3} m^{\frac{2}{3}}$$

or

$$-10^{-3} t = \int_{m_0}^m m^{-\frac{2}{3}} dm,$$

where m_0 the initial mass of the protoplanet.

or

$$-10^{-3} t = 3 \left[m^{\frac{1}{3}} \right]_{m_0}^m$$

or

$$m^{\frac{1}{3}} = m_0^{\frac{1}{3}} - \frac{1}{3} \times 10^{-3} t.$$

If we take $m_0 = 10^{30}$ gm, then

$$m^{1/3} = 10^{10} - \frac{1}{3} \times 10^{-3} t$$

or

$$m = \left(10^{10} - \frac{1}{3} \times 10^{-3} t \right)^3.$$

Therefore,

$$\frac{1}{m} \frac{dm}{dt} = - \frac{10^{-3} m^{2/3}}{\left(10^{10} - \frac{10^{-3}}{3} t \right)^3}$$

or

$$\frac{1}{m} \frac{dm}{dt} = - \frac{10^{-3}}{\left(10^{10} - \frac{10^{-3}}{3} t \right)^3} \times \left(10^{10} - \frac{10^{-3}}{3} t \right)^2$$

or

$$\frac{1}{m} \frac{dm}{dt} = - \frac{10^{-3}}{10^{10} - \frac{10^{-3}}{3} t}$$

or

$$\frac{1}{m} \frac{dm}{dt} = - \frac{3}{3 \times 10^{13} - t}. \quad (5.8)$$

Substituting $\frac{1}{m} \frac{dm}{dt}$ from equation (5.8) in (5.7), we get

$$\left. \begin{aligned} \frac{d^2 x}{dt^2} &= \frac{3 \frac{dx}{dt}}{3 \times 10^{13} - t} - \frac{GM_{\oplus} x}{(x^2 + y^2)^{3/2}} \\ \frac{d^2 y}{dt^2} &= \frac{3 \frac{dy}{dt}}{3 \times 10^{13} - t} - \frac{GM_{\oplus} y}{(x^2 + y^2)^{3/2}} \end{aligned} \right\} \quad (5.9)$$

To determine the orbit we have to solve (5.9) with known initial conditions. It should be noted that to avoid tidal disruption a protoplanet must have formed outside the Roche limit defined by

$$R = R_{\oplus} \left(\frac{\alpha \rho}{\rho_{\oplus}} \right)^{-1/3},$$

where R_{\odot} and ρ_{\odot} are the radius and density of the Sun and α a dimensionless parameter whose numerical values lie between 1 and 3 (e.g., Williams 1977). With appropriate values of the parameters this distance is $R = 4.34 \times 10^{13}$ cm. So the initial distance of the protoplanet must be $> 4.34 \times 10^{13}$ cm. As initial conditions we take

$$\begin{aligned}x &= 10^{14} \text{ cm,} \\y &= 0, \\ \dot{x} &= 0, \\ \dot{y} &= 1.2 \times 10^6 \text{ cm/sec.}\end{aligned}$$

where the initial angular velocity ω_0 has been taken arbitrarily as $1.6789 \times 10^{-8} \text{ sec}^{-1}$ which is less than the present day angular velocity of Mars.

Now, we replace the variables x , y and t by the dimensionless variables X , Y and τ respectively by the following set of relations:

$$\left. \begin{aligned}x &= 10^{14} X \\ y &= 10^{14} Y \\ t &= 10^{10} \tau\end{aligned} \right\}, \quad (5.10)$$

where τ has been measured in units of thousand years.

Then (5.9) becomes

$$\left. \begin{aligned}\frac{10^{14}}{10^{20}} \frac{d^2 X}{d\tau^2} &= \frac{3 \times \frac{10^{14}}{10^{10}}}{3 \times 10^{12} - 10^{10} \tau} \frac{dX}{d\tau} - \frac{10^{14} GM_{\odot} X}{10^{42} (X^2 + Y^2)^{\frac{3}{2}}} \\ \frac{10^{14}}{10^{20}} \frac{d^2 Y}{d\tau^2} &= \frac{3 \times \frac{10^{14}}{10^{10}}}{3 \times 10^{12} - 10^{10} \tau} \frac{dY}{d\tau} - \frac{10^{14} GM_{\odot} Y}{10^{42} (X^2 + Y^2)^{\frac{3}{2}}}\end{aligned} \right\}$$

or

$$\left. \begin{aligned} \frac{d^2 X}{d\tau^2} &= \frac{3 \times 10^{10}}{3 \times 10^{13} - 10^{10} \tau} \frac{dX}{d\tau} - \frac{GM_{\odot} X}{10^{22} (X^2 + Y^2)^{\frac{3}{2}}} \\ \frac{d^2 Y}{d\tau^2} &= \frac{3 \times 10^{10}}{3 \times 10^{13} - 10^{10} \tau} \frac{dY}{d\tau} - \frac{GM_{\odot} Y}{10^{22} (X^2 + Y^2)^{\frac{3}{2}}} \end{aligned} \right\}$$

or

$$\left. \begin{aligned} \frac{d^2 X}{d\tau^2} &= \frac{3}{3000 - \tau} \frac{dX}{d\tau} - \frac{GM_{\odot} X}{10^{22} (X^2 + Y^2)^{\frac{3}{2}}} \\ \frac{d^2 Y}{d\tau^2} &= \frac{3}{3000 - \tau} \frac{dY}{d\tau} - \frac{GM_{\odot} Y}{10^{22} (X^2 + Y^2)^{\frac{3}{2}}} \end{aligned} \right\}$$

Introducing the parameters involved, we get

$$\left. \begin{aligned} \frac{d^2 X}{d\tau^2} &= \frac{3}{3000 - \tau} \frac{dX}{d\tau} - \frac{6.675 \times 10^{-8} \times 1.989 \times 10^{33} X}{10^{22} (X^2 + Y^2)^{\frac{3}{2}}} \\ \frac{d^2 Y}{d\tau^2} &= \frac{3}{3000 - \tau} \frac{dY}{d\tau} - \frac{6.675 \times 10^{-8} \times 1.989 \times 10^{33} Y}{10^{22} (X^2 + Y^2)^{\frac{3}{2}}} \end{aligned} \right\}$$

$$\left. \begin{aligned} \frac{d^2 X}{d\tau^2} &= \frac{3}{3000 - \tau} \frac{dX}{d\tau} - \frac{13276.575 X}{(X^2 + Y^2)^{\frac{3}{2}}} \\ \frac{d^2 Y}{d\tau^2} &= \frac{3}{3000 - \tau} \frac{dY}{d\tau} - \frac{13276.575 Y}{(X^2 + Y^2)^{\frac{3}{2}}} \end{aligned} \right\} \quad (5.11)$$

To solve the equations in (5.11), we break these equations into the four equations as follows:

$$\frac{dX}{d\tau} = u, \quad (5.12)$$

$$\frac{dY}{d\tau} = v, \quad (5.13)$$

$$\frac{du}{d\tau} = \frac{3u}{3000 - \tau} - \frac{13276.525}{(X^2 + Y^2)^{\frac{3}{2}}} X \quad (5.14)$$

and

$$\frac{dv}{d\tau} = \frac{3v}{3000 - \tau} - \frac{13276.525}{(X^2 + Y^2)^{\frac{3}{2}}} Y. \quad (5.15)$$

The initial conditions now reduce to

$$\begin{aligned} &\text{at } \tau = 0, \\ &\left. \begin{aligned} X &= 1, \\ Y &= 0, \\ u = \dot{X} &= 0, \\ v = \dot{Y} &= 120 \end{aligned} \right\} \quad (5.16) \end{aligned}$$

We have solved equations (5.12), (5.13), (5.14) and (5.15) using (5.16) by the 4th order Runge-Kutta method. The solution is shown in figure 5.1. It is immediately evident from the figure that as mass loss proceeds the orbital distance increases.

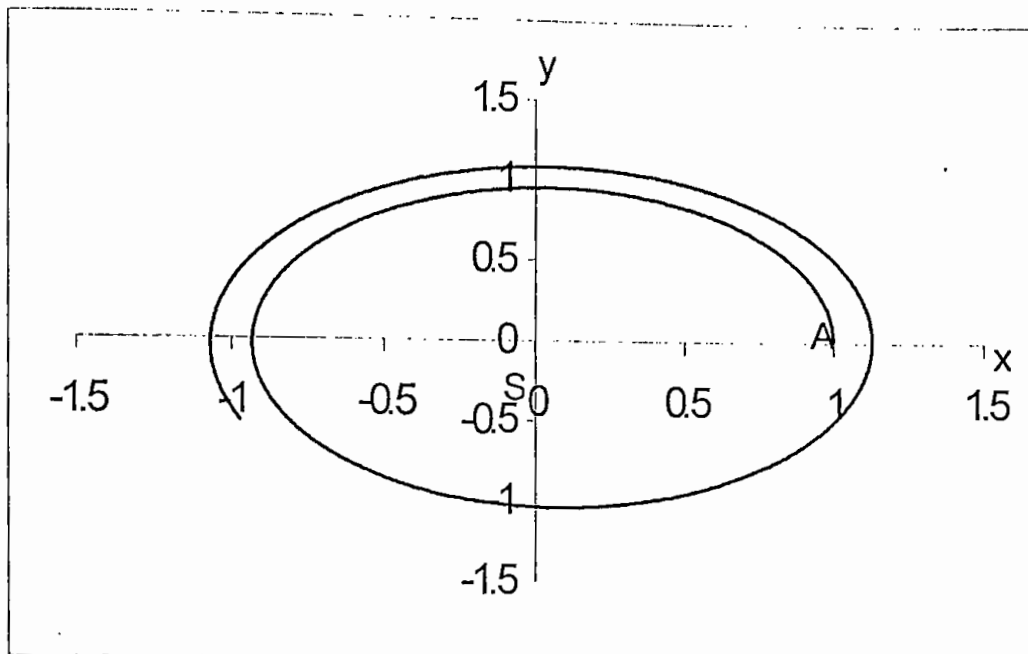

Fig. 5.1: Orbital distance of a protoplanet as it loses mass in a two body system
A is the initial position of the protoplanet, S is the position of the Sun

ii) *Three body problem:*

The effect of mass loss in a two body problem is to push the planets outward. This is not in conformity with the observed distributions of the planetary distances in the inner part of the solar system. The dynamics of the solar system is, of course, a complicated many body problem. However, since all the protoplanets suffered mass loss excepting Jupiter the dynamics can be treated as a three body problem. Let M_{\odot} be the mass of the Sun and M_J the mass of Jupiter which revolves about

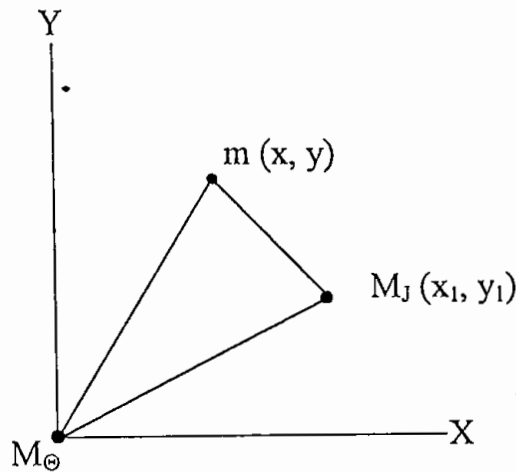

Fig. 5.2: Motion of a protoplanet with mass loss
in the field of the Sun and Jupiter.

the Sun with constant angular velocity ω . Let a third body of smaller mass m , say, which suffers mass loss, moves in a mutual gravitational field of the Sun and Jupiter. We also assume that the motion of the body is in the same plane as that of Jupiter. Then the orbit of the body can be determined by using the Lagrangian technique. Let at any time the coordinates of m be (x, y) with respect to a fixed

frame of reference with origin at the centre of the Sun, and (x_1, y_1) be the coordinates of Jupiter. If a is the constant distance between M_\odot and M_J , then

$$\left. \begin{aligned} x_1 &= a \cos \omega t \\ y_1 &= a \sin \omega t \end{aligned} \right\} \quad (5.17)$$

Then the kinetic energy T is given by

$$T = \frac{1}{2} m (\dot{x}^2 + \dot{y}^2) \quad (5.18)$$

and the mutual potential energy V is given by (e.g., Blanco et al 1961)

$$V = - \left(\frac{GM_\odot m}{r_1} + \frac{GM_J m}{r_2} + \frac{GM_\odot M_J}{a} \right), \quad (5.19)$$

where $r_1 = (x^2 + y^2)^{\frac{1}{2}}$ (5.20)

and $r_2 = ((x - x_1)^2 + (y - y_1)^2)^{\frac{1}{2}}$. (5.21)

We know that Lagrangian is given by

$$L = T + G \left(\frac{M_\odot m}{r_1} + \frac{M_J m}{r_2} + \frac{M_\odot M_J}{a} \right).$$

Substituting for T and V from (5.18) and (5.19) respectively, we get

$$L = \frac{1}{2} m (\dot{x}^2 + \dot{y}^2) + G \left(\frac{M_\odot m}{r_1} + \frac{M_J m}{r_2} + \frac{M_\odot M_J}{a} \right). \quad (5.22)$$

Now, Lagrange's equations of motions are given by

$$\frac{d}{dt} \left(\frac{\partial L}{\partial \dot{x}} \right) - \frac{\partial L}{\partial x} = 0 \quad (5.23)$$

and
$$\frac{d}{dt} \left(\frac{\partial L}{\partial y} \right) - \frac{\partial L}{\partial y} = 0. \quad (5.24)$$

Now, from (5.22), we get

$$\frac{\partial L}{\partial x} = m x \quad (5.25)$$

and
$$\frac{\partial L}{\partial x} = Gm \left(-M_{\odot} x (x^2 + y^2)^{-\frac{3}{2}} - M_J \left\{ (x - x_1)^2 + (y - y_1)^2 \right\} (x - x_1) \right)$$

or
$$\frac{\partial L}{\partial x} = -Gm \left(\frac{M_{\odot} x}{(x^2 + y^2)^{\frac{3}{2}}} + \frac{M_J (x - x_1)}{\left\{ (x - x_1)^2 + (y - y_1)^2 \right\}^{\frac{3}{2}}} \right)$$

or
$$\frac{\partial L}{\partial x} = -Gm \left(\frac{M_{\odot} x}{r_1^3} + \frac{M_J (x - x_1)}{r_2^3} \right). \quad (5.26)$$

Similarly,

$$\frac{\partial L}{\partial y} = m y \quad (5.27)$$

and
$$\frac{\partial L}{\partial y} = -Gm \left(\frac{M_{\odot} y}{r_1^3} + \frac{M_J (y - y_1)}{r_2^3} \right). \quad (5.28)$$

Now using (5.25) and (5.26) in equation (5.23), we get

$$\frac{d}{dt} (m x) + Gm \left\{ \frac{M_{\odot} x}{r_1^3} + \frac{M_J (x - x_1)}{r_2^3} \right\} = 0$$

or
$$m \frac{d^2 x}{dt^2} + \frac{dx}{dt} \frac{dm}{dt} + Gm \left\{ \frac{M_{\odot} x}{r_1^3} + \frac{M_J (x - x_1)}{r_2^3} \right\} = 0$$

or
$$\frac{d^2 x}{dt^2} + \frac{1}{m} \frac{dm}{dt} \frac{dx}{dt} + G \left\{ \frac{M_{\odot} x}{r_1^3} + \frac{M_J (x - x_1)}{r_2^3} \right\} = 0. \quad (5.29)$$

Similarly, using (5.27) and (5.28) in equation (5.24), we get

$$\frac{d^2 y}{dt^2} + \frac{1}{m} \frac{dm}{dt} \frac{dy}{dt} + G \left\{ \frac{M_{\odot} y}{r_1^3} + \frac{M_J (y - y_1)}{r_2^3} \right\} = 0. \quad (5.30)$$

Now using the mass loss rate (5.4), i.e.,

$$\frac{dm}{dt} = -10^{-3} m^{2/3}$$

we have

$$\frac{1}{m} \frac{dm}{dt} = - \frac{3 \times 10^{-3}}{3m_0^{2/3} - 10^{-3} t}, \quad (5.31)$$

where m_0 is the initial mass of the body.

Substituting $\frac{1}{m} \frac{dm}{dt}$ from equation (5.31) in (5.29), we get

$$\frac{d^2 x}{dt^2} - \frac{3 \frac{dx}{dt}}{3 \times 10^3 m_0^{2/3} - t} + G \left\{ \frac{M_{\odot} x}{r_1^3} + \frac{M_J (x - x_1)}{r_2^3} \right\} = 0$$

or

$$\frac{d^2 x}{dt^2} = \frac{3 \frac{dx}{dt}}{3 \times 10^3 m_0^{2/3} - t} - G \left\{ \frac{M_{\odot} x}{r_1^3} + \frac{M_J (x - x_1)}{r_2^3} \right\}. \quad (5.32)$$

Similarly, substituting $\frac{1}{m} \frac{dm}{dt}$ from equation (5.31) in (5.30), we get

$$\frac{d^2 y}{dt^2} = \frac{3 \frac{dy}{dt}}{3 \times 10^3 m_0^{2/3} - t} - G \left\{ \frac{M_{\odot} y}{r_1^3} + \frac{M_J (y - y_1)}{r_2^3} \right\}. \quad (5.33)$$

Now, using (5.20) and (5.21) in (5.32), we get

$$\frac{d^2 x}{dt^2} = \frac{3 \frac{dx}{dt}}{3 \times 10^3 m_0^{2/3} - t} - G \left[\frac{M_{\odot} x}{r_1^3} + \frac{M_J (x - a \cos \omega t)}{r_2^3} \right], \quad (5.34)$$

where
$$r_1 = (x^2 + y^2)^{\frac{1}{2}} \quad (5.35)$$

and
$$r_2 = \left\{ (x - a \cos \omega t)^2 + (y - a \sin \omega t)^2 \right\}^{\frac{1}{2}}. \quad (5.36)$$

Similarly, using (5.20) and (5.21) in (5.33), we get

$$\frac{d^2 y}{dt^2} = \frac{3 \frac{dy}{dt}}{3 \times 10^3 m_0^{\frac{1}{3}} - t} - G \left[\frac{M_\odot y}{r_1^3} + \frac{M_J (y - a \sin \omega t)}{r_2^3} \right]. \quad (5.37)$$

Case (i): The body is within M_\odot and M_J

When the protoplanet is an interior one we consider the following initial conditions:

$$x = 5 \times 10^{13} \text{ cm}, \quad \dot{x} = 0 \text{ at } t = 0.$$

$$y = 0, \quad \dot{y} = 1.5 \times 10^6 \text{ cm/sec at } t = 0.$$

Now we replace the variables x , y and t by the non dimensional variables X , Y and τ by the relations given below:

$$\left. \begin{aligned} x &= 5 \times 10^{13} X \\ y &= 5 \times 10^{13} Y \\ t &= 10^{10} \tau \end{aligned} \right\}.$$

Then from equation (5.34), we get

$$\begin{aligned} \frac{5 \times 10^{13}}{10^{20}} \frac{d^2 X}{d\tau^2} &= \frac{3 \frac{5 \times 10^{13}}{10^{10}} \frac{dX}{d\tau}}{3 \times 10^3 m_0^{\frac{1}{3}} - 10^{10} \tau} - G \left[\frac{5 \times 10^{13} M_\odot X}{1.25 \times 10^{41} (X^2 + Y^2)^{\frac{3}{2}}} \right] \\ &- G \left[\frac{M_J \{5 \times 10^{13} X - a \cos(10^{10} \omega \tau)\}}{\left\{ (5 \times 10^{13} X - a \cos(10^{10} \omega \tau))^2 + (5 \times 10^{13} Y - a \sin(10^{10} \omega \tau))^2 \right\}^{\frac{3}{2}}} \right] \end{aligned}$$

$$\begin{aligned}
 \frac{d^2 X}{d\tau^2} &= \frac{3 \frac{dX}{d\tau}}{3 \times 10^{-7} m_0^{\frac{1}{3}} - \tau} - G \left[\frac{10^{20} M_\oplus X}{1.25 \times 10^{41} (X^2 + Y^2)^{\frac{3}{2}}} \right] \\
 \text{or} & \left[-G \frac{10^{20} M_J \left\{ X - \frac{a}{5 \times 10^{13}} \cos(10^{10} \omega \tau) \right\}}{1.25 \times 10^{41} \left(\left\{ X - \frac{a}{5 \times 10^{13}} \cos(10^{10} \omega \tau) \right\}^2 + \left\{ Y - \frac{a}{5 \times 10^{13}} \sin(10^{10} \omega \tau) \right\}^2 \right)^{\frac{3}{2}}} \right] \\
 \frac{d^2 X}{d\tau^2} &= \frac{3 \frac{dX}{d\tau}}{3 \times 10^{-7} m_0^{\frac{1}{3}} - \tau} - \frac{G m_1}{1.25 \times 10^{21}} \left[\frac{X}{(X^2 + Y^2)^{\frac{3}{2}}} \right] \\
 \text{or} & \left[- \frac{\frac{G m_2}{1.25 \times 10^{21}} \left\{ X - \frac{a}{5 \times 10^{13}} \cos(10^{10} \omega \tau) \right\}}{\left(\left\{ X - \frac{a}{5 \times 10^{13}} \cos(10^{10} \omega \tau) \right\}^2 + \left\{ Y - \frac{a}{5 \times 10^{13}} \sin(10^{10} \omega \tau) \right\}^2 \right)^{\frac{3}{2}}} \right] \quad (5.38)
 \end{aligned}$$

Similarly, from (5.37), we get

$$\begin{aligned}
 \frac{d^2 Y}{d\tau^2} &= \frac{3 \frac{dY}{d\tau}}{3 \times 10^{-7} m_0^{\frac{1}{3}} - \tau} - \frac{G m}{1.25 \times 10^{20}} \left[\frac{Y}{(X^2 + Y^2)^{\frac{3}{2}}} \right] \\
 & \left[- \frac{\frac{G m_2}{1.25 \times 10^{21}} \left\{ Y - \frac{a}{5 \times 10^{13}} \sin(10^{10} \omega \tau) \right\}}{\left(\left\{ X - \frac{a}{5 \times 10^{13}} \cos(10^{10} \omega \tau) \right\}^2 + \left\{ Y - \frac{a}{5 \times 10^{13}} \sin(10^{10} \omega \tau) \right\}^2 \right)^{\frac{3}{2}}} \right] \quad (5.39)
 \end{aligned}$$

Now $M_J = 1.8994 \times 10^{30}$ gm and $a = 7.7791 \times 10^{13}$ cm. The mean orbital velocity of Jupiter is $v = 1.306 \times 10^6$ cm sec⁻¹. Therefore the mean angular velocity of

Jupiter is $\omega = \frac{v}{a} = \frac{1.306 \times 10^6}{7.7791 \times 10^{13}} = 1.6789 \times 10^{-8} \text{ sec}^{-1}$. Now taking

$M_{\oplus} = 1.989 \times 10^{33} \text{ gm}$ and $m_0 = 10^{30} \text{ gm}$, we get

$$3 \times 10^{-7} m_0^{\frac{1}{3}} = 3 \times 10^{-7} \times (10^{30})^{\frac{1}{3}} = 3000,$$

$$\frac{\alpha}{5 \times 10^{13}} = \frac{7.7791 \times 10^{13}}{5 \times 10^{13}} = 1.5558,$$

It is to be noted that m_0 has been taken as $10^{30} < M_J$, so that it does not disturb the motion of M_J .

Now from equation (5.38), we get

$$\begin{aligned} \frac{d^2 X}{d\tau^2} = & \frac{3 \frac{dX}{d\tau}}{3000 - \tau} \\ & - \frac{6.675 \times 10^{-8} \times 1.989 \times 10^{33}}{1.25 \times 10^{21}} \left[\frac{X}{(X^2 + Y^2)^{\frac{3}{2}}} \right] \\ & - \frac{6.675 \times 10^{-8} \times 1.8994 \times 10^{30}}{1.25 \times 10^{21}} P, \end{aligned}$$

where

$$P = \frac{(X - 1.5558 \cos q)}{\left((X - 1.5558 \cos q)^2 + (Y - 1.5558 \sin q)^2 \right)^{\frac{3}{2}}}$$

with

$$q = 10^{10} \omega \tau = 167.89 \tau.$$

or

$$\begin{aligned} \frac{d^2 X}{d\tau^2} = & \frac{3 \frac{dX}{d\tau}}{3000 - \tau} - \frac{1.0621 \times 10^5 X}{(X^2 + Y^2)^{\frac{3}{2}}} \\ & - \frac{101.42796 \{X - 1.5558 \cos(167.89\tau)\}}{\left(\{X - 1.5558 \cos(167.89\tau)\}^2 + \{Y - 1.5558 \sin(167.89\tau)\}^2 \right)^{\frac{3}{2}}}. \end{aligned} \quad (5.40)$$

Similarly, from equation (5.39), we get

$$\frac{d^2Y}{d\tau^2} = \frac{3 \frac{dY}{d\tau}}{3000 - \tau} - \frac{1.0621 \times 10^5 Y}{(X^2 + Y^2)^{\frac{3}{2}}} - \frac{101.42796 \{Y - 1.5558 \sin(167.89\tau)\}}{\left(\{X - 1.5558 \cos(167.89\tau)\}^2 + \{Y - 1.5558 \sin(167.89\tau)\}^2 \right)^{\frac{3}{2}}}$$
(5.41)

To solve the equations (5.40) and (5.41), we break these equations into the four equations as follows:

$$\frac{dX}{d\tau} = u, \quad (5.42)$$

$$\frac{dY}{d\tau} = v, \quad (5.43)$$

$$\frac{du}{d\tau} = \frac{3u}{3000 - \tau} - \frac{1.0621 \times 10^5 X}{(X^2 + Y^2)^{\frac{3}{2}}} - \frac{101.42796 \{X - 1.5558 \cos(167.89\tau)\}}{\left(\{X - 1.5558 \cos(167.89\tau)\}^2 + \{Y - 1.5558 \sin(167.89\tau)\}^2 \right)^{\frac{3}{2}}}$$
(5.44)

and

$$\frac{dv}{d\tau} = \frac{3v}{3000 - \tau} - \frac{1.0621 \times 10^5 Y}{(X^2 + Y^2)^{\frac{3}{2}}} - \frac{101.42796 \{Y - 1.5558 \sin(167.89\tau)\}}{\left(\{X - 1.5558 \cos(167.89\tau)\}^2 + \{Y - 1.5558 \sin(167.89\tau)\}^2 \right)^{\frac{3}{2}}}$$
(5.45)

$$\text{with conditions } \left. \begin{array}{l} \tau = 0 \\ X = 1 \\ Y = 0 \\ u = \dot{X} = 0 \\ v = \dot{Y} = 300 \end{array} \right\} \quad (5.46)$$

We have solved equations (5.42), (5.43), (5.44) and (5.45) using (5.46) with the help of the 4th order Runge-Kutta method. The solution is shown in figure 5.2. The diagram clearly shows that the protoplanet spirals in as it loses mass.

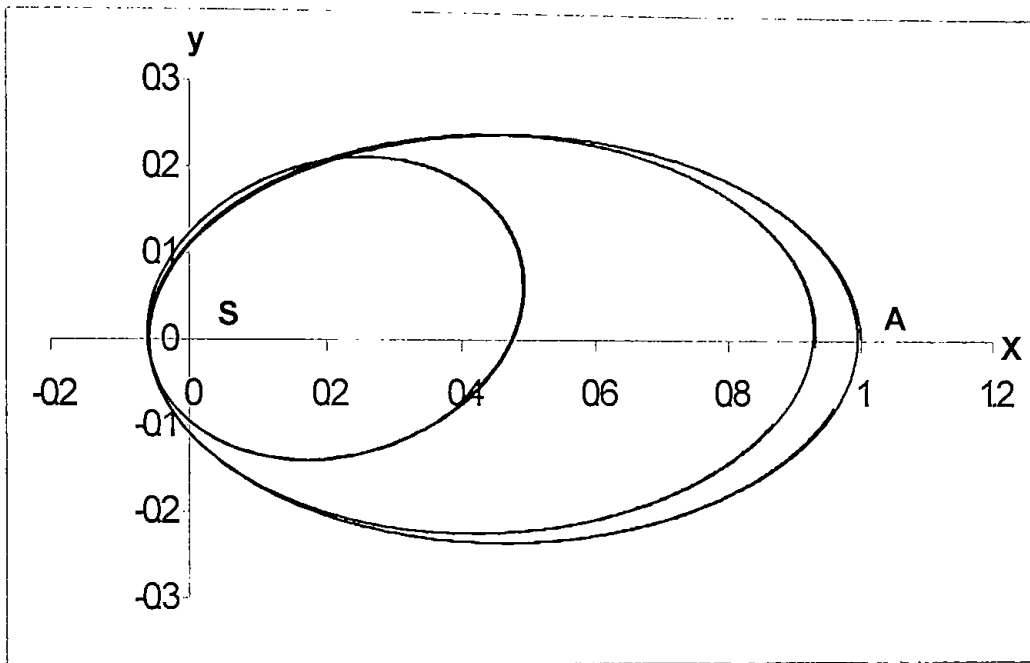

Fig. 5.3: Orbital distance of an interior protoplanet as it loses mass in a three body system . A is the interior position of the protoplanet and S is the position of the Sun.

Case (ii): The body is an exterior protoplanet

In this case the initial conditions are taken as:

$$x = 10^{14} \text{ cm, } \dot{x} = 0 \text{ at } t = 0$$

$$y = 0, \quad \dot{y} = 1.1 \times 10^6 \text{ cm/sec at } t = 0.$$

Now we replace the variables x , y and t by the non dimensional variables X , Y and τ by the relations given below

$$\left. \begin{aligned} x &= 10^{14} X \\ y &= 10^{14} Y \\ t &= 10^{10} \tau \end{aligned} \right\}.$$

Then from equation (5.34), we get

$$\frac{10^{14}}{10^{20}} \frac{d^2 X}{d\tau^2} = \frac{3 \frac{10^{14}}{10^{10}} \frac{dX}{d\tau}}{3 \times 10^3 m_0^{\frac{1}{3}} - 10^{10} \tau} - G \left[\frac{10^{14} M_{\odot} X}{10^{42} (X^2 + Y^2)^{\frac{3}{2}}} \right]$$

$$- G \left[\frac{M_J \{10^{14} X - a \cos(10^{10} \omega \tau)\}}{\left(\{10^{14} X - a \cos(10^{10} \omega \tau)\}^2 + \{10^{14} Y - a \sin(10^{10} \omega \tau)\}^2 \right)^{\frac{3}{2}}} \right]$$

$$\frac{d^2 X}{d\tau^2} = \frac{3 \frac{dX}{d\tau}}{3 \times 10^{-7} m_0^{\frac{1}{3}} - \tau} - \frac{GM_{\odot}}{10^{22}} \left[\frac{X}{(X^2 + Y^2)^{\frac{3}{2}}} \right]$$

or

$$- \frac{GM_J}{10^{22}} \left[\frac{\left\{ X - \frac{a}{10^{14}} \cos(10^{10} \omega \tau) \right\}}{\left(\left\{ X - \frac{a}{10^{14}} \cos(10^{10} \omega \tau) \right\}^2 + \left\{ Y - \frac{a}{10^{14}} \sin(10^{10} \omega \tau) \right\}^2 \right)^{\frac{3}{2}}} \right]$$

Inserting the parameters involved, we get

$$\frac{d^2 X}{d\tau^2} = \frac{3 \frac{dX}{d\tau}}{3 \times 10^{-7} (10^{30})^{\frac{1}{3}} - \tau} - \frac{6.675 \times 10^{-8} \times 1.989 \times 10^{33}}{10^{22}} \left[\frac{X}{(X^2 + Y^2)^{\frac{3}{2}}} \right] \quad (5.47)$$

$$- \frac{6.675 \times 10^{-8} \times 1.8994 \times 10^{30}}{10^{22}} p,$$

where

$$p = \frac{\{X - \frac{7.7791 \times 10^{13}}{10^{14}} \cos q\}}{\left(\{X - \frac{7.7791 \times 10^{13}}{10^{14}} \cos q\}^2 + \{Y - \frac{7.7791 \times 10^{13}}{10^{14}} \sin q\}^2 \right)^{\frac{3}{2}}}$$

$$= \frac{\{X - .77791 \cos q\}}{\left(\{X - .77791 \cos q\}^2 + \{Y - .77791 \sin q\}^2 \right)^{\frac{3}{2}}},$$

where $q = 10^{10} \omega \tau = 10^{10} \times 1.6789 \times 10^{-8} = 167.89$

Therefore, from equation (5.47), we get

$$\frac{d^2 X}{d\tau^2} = \frac{3 \frac{dX}{d\tau}}{3000 - \tau} - \frac{1.3277 \times 10^4 X}{(X^2 + Y^2)^{\frac{3}{2}}} \quad (5.48)$$

$$- \frac{12.6785 \{X - .77791 \cos(167.89\tau)\}}{\left(\{X - .77791 \cos(167.89\tau)\}^2 + \{Y - .77791 \sin(167.89\tau)\}^2 \right)^{\frac{3}{2}}}.$$

Similarly from equation (5.37), we get

$$\frac{d^2 Y}{d\tau^2} = \frac{3 \frac{dY}{d\tau}}{3000 - \tau} - \frac{1.3277 \times 10^4 Y}{(X^2 + Y^2)^{\frac{3}{2}}} \quad (5.49)$$

$$- \frac{12.6785 \{Y - .77791 \sin(167.89\tau)\}}{\left(\{X - .77791 \cos(167.89\tau)\}^2 + \{Y - .77791 \sin(167.89\tau)\}^2 \right)^{\frac{3}{2}}}.$$

To solve the equations (5.48) and (5.49), we break these equations into the four equations as follows:

$$\frac{dX}{d\tau} = u, \quad (5.50)$$

$$\frac{dY}{d\tau} = v, \quad (5.51)$$

$$\frac{du}{d\tau} = \frac{3u}{646.33 - \tau} - \frac{1.3277 \times 10^4 X}{(X^2 + Y^2)^{\frac{3}{2}}} \frac{12.6785\{X - .77791 \cos(167.89\tau)\}}{\left(\{X - .77791 \cos(167.89\tau)\}^2 + \{Y - .77791 \sin(167.89\tau)\}^2\right)^{\frac{3}{2}}} \quad (5.52)$$

and

$$\frac{dv}{d\tau} = \frac{3v}{646.33 - \tau} - \frac{1.3277 \times 10^4 Y}{(X^2 + Y^2)^{\frac{3}{2}}} \frac{12.6785\{Y - .77791 \sin(167.89\tau)\}}{\left(\{X - .77791 \cos(167.89\tau)\}^2 + \{Y - .77791 \sin(167.89\tau)\}^2\right)^{\frac{3}{2}}} \quad (5.53)$$

With conditions

$$\left. \begin{array}{l} \tau = 0 \\ X = 1 \\ Y = 0 \\ u = \dot{X} = 0 \\ v = \dot{Y} = 110 \end{array} \right\} \quad (5.54)$$

We have solved equations (5.50), (5.51), (5.52) and (5.53) using conditions (5.54) with the help of the 4th order Runge-Kutta method. The solution is shown in figure 5.4.

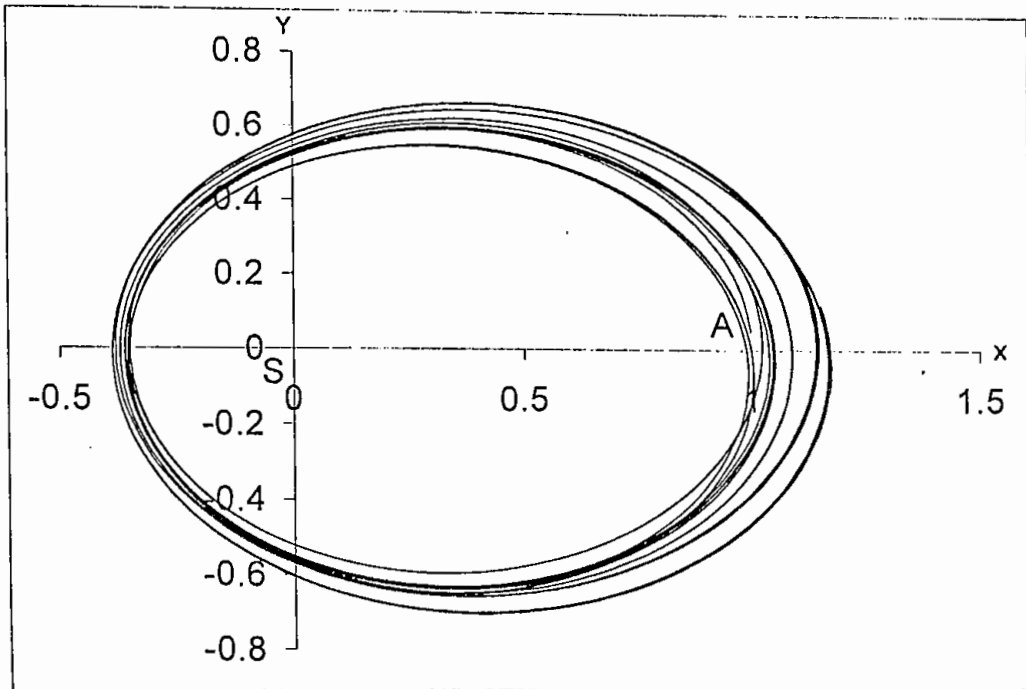

Fig. 5.4: Orbital distance of an outer protoplanet as it loses mass in a three body system . A is the initial position of the protoplanet and S the position of the Sun.

It is evident from the diagram that the protoplanet is pushed outward as it loses mass. Figures 5.2 and 5.3 clearly indicate that the orbital distance of a protoplanet losing mass is in qualitative agreement with observation, the orbit being always elliptical.

Comparison with observation

With our calculated data we obtain a plot of $\log(\text{aphelion distance})$ against $\log(\text{mass})$ in fig. 5.5.

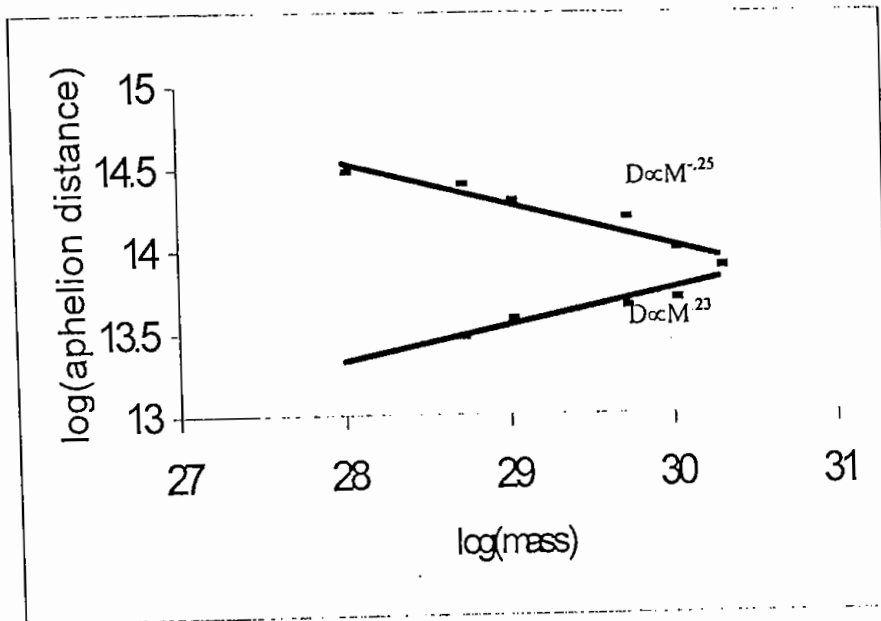

Fig. 5.5: The predicted mass distance relation

It is found that the distance-mass relation is given by the form

$$D \propto M^{\alpha} . \quad (5.55)$$

When D is the distance, M is the mass .

$$\alpha = -.25 \text{ for outer planets}$$

$$= +.23 \text{ for the inner planets.}$$

If D_J and M_J are the values of the parameters for Jupiter, then from (5.55) we have

$$\frac{D}{D_J} = \left(\frac{M}{M_J} \right)^{\alpha} . \quad (5.56)$$

It is now easy to calculate the distance of a planet for any known value of M In the table below 5.1 we compare the theoretically predicted distances with the observed distances of the present day planets.

Table 5.1
Comparison of the predicted distance with observation

Planets	Mercury	Venus	Earth	Mars	Jupiter	Saturn	Uranus	Neptune	Pluto
Mass (gm)	2.99 $\times 10^{26}$	4.78 $\times 10^{27}$	5.98 $\times 10^{27}$	6.42 $\times 10^{26}$	1.90 $\times 10^{30}$	5.69 $\times 10^{29}$	8.69 $\times 10^{28}$	1.03 $\times 10^{29}$	1.02 $\times 10^{27}$
Predicted distance (cm)	1.08 $\times 10^{13}$	2.05 $\times 10^{13}$	2.16 $\times 10^{13}$	1.29 $\times 10^{13}$	7.78 $\times 10^{13}$	1.10 $\times 10^{14}$	1.76 $\times 10^{14}$	1.68 $\times 10^{14}$	5.35 $\times 10^{14}$
Observed distance (cm)	7.07 $\times 10^{12}$	1.08 $\times 10^{13}$	1.52 $\times 10^{13}$	2.48 $\times 10^{13}$	7.78 $\times 10^{13}$	1.5 $\times 10^{14}$	3 $\times 10^{14}$	4.52 $\times 10^{14}$	7.39 $\times 10^{14}$

4. Conclusion

We have investigated the effect of mass loss on the protoplanetary orbits. In a two body problem the orbital distance is found to increase as a result of mass loss.

However, in a three body problem with the Sun, Jupiter and the protoplanet under consideration, all being in the same plane, there is found a clear division in the effect of mass loss on protoplanetary orbits. For the interior protoplanets (i.e., within the Sun and Jupiter) mass loss decreases the orbital distance whereas for the outer protoplanets the orbital distances are found to increase as mass loss proceeds. The mass-distance relation is found to be given by a power law form. The predicted distances of the present day planets with known masses ^{are} ~~all~~ found to be in good agreement with the observed distances. We, therefore, conclude that mass loss from a set of identical protoplanets can explain the distribution of planetary distances as observed today.

5. References

- Bhattacharjee, S. K., 1983. *GANIT, Journal of Bangladesh Math Soc.*, 3, 182.
- Bhattacharjee, S. K., 1980. *Ph. D. thesis*, University of London.
- Williams, I. P. and Bhattacharjee, S. K., 1979. *Astrophys. Space Sci.*, 66, 219.
- Blanco, V. M. and McCUSKEY, S. W., 1961. *Basic Physics of the solar system*, Addison-Wesley Publishing Company, INC.
- Donnison, J. R. and Williams, I. P., 1977. *MNRAS*, 180, 281.
- McCrea, W.H. and Williams, I. P., 1965. *Proc. Roy. Soc., A*, 287, 143.
- Williams, I. P., 1977. *Comets, Asteroids and Meteoroids*, Ed. A. H. Delsemme, Toledo U. P.
- Williams, I. P. and Crampin, D. J., 1971, *MNRAS*, 152, 261.
- Williams, I. P. and Handbury, M. J., 1974. *Astrophys. Space Sci.*, 30, 215.