

University of Rajshahi

Rajshahi-6205

Bangladesh.

RUCL Institutional Repository

<http://rulrepository.ru.ac.bd>

Department of Management studies

PhD Thesis

2020

Industrial Relations in Ready-Made Garment Industry of Bangladesh

Uddin, Md. Shawan

University of Rajshahi

<http://rulrepository.ru.ac.bd/handle/123456789/1079>

Copyright to the University of Rajshahi. All rights reserved. Downloaded from RUCL Institutional Repository.

**INDUSTRIAL RELATIONS IN READY-MADE
GARMENT INDUSTRY OF BANGLADESH**

THESIS SUBMITTED FOR THE AWARD OF THE DEGREE

OF

DOCTOR OF PHILOSOPHY

By

MD. SHAWAN UDDIN



**DEPARTMENT OF MANAGEMENT STUDIES
FACULTY OF BUSINESS STUDIES
UNIVERSITY OF RAJSHAHI**

DECEMBER 2020

DECLARATION

To the best of my knowledge and belief this thesis contains no materials previously published by any other person except where due acknowledgement has been made. This thesis contains no material, which has been accepted for the award of any other degree or diploma in any university.

Date:

(Md. Shawan Uddin)

Ph.D Fellow

Roll No: 13307

Registration No: 1976

Session: 2013-2014

Department of Management Studies

University of Rajshahi

**Department of Management Studies
University of Rajshahi
Rajshahi-6205, Bangladesh
e-mail:managementstudies@ru.ac.bd
Phone : +88 (0721) 711132
Fax : +88 (0721) 750064**



**Sheikh M. Nurullah
Professor
Dept. of Management Studies
e-mail: nurullah_sm@ru.ac.bd
Phone : +88 (0721) 711896
Cell : +880-01726718845**

CERTIFICATE

This is to certify that the thesis entitled “**Industrial Relations in Ready-Made Garment Industry of Bangladesh**” submitted to the Department of Management Studies at the University of Rajshahi in Bangladesh for the award of the degree of Doctor of Philosophy by Md. Shawan Uddin, Ph.D fellow of the session 2013-2014, is an original research work completed under my supervision. I have meticulously gone through the whole thesis. I believe that the researcher has worked with utmost sincerity while preparing this thesis and the thesis, in my opinion, deserves consideration for the award of the Ph.D degree.

Principal Supervisor

(Sheikh M. Nurullah)

**Department of Management Studies
Jagannath University
9-10, Chittaranjan Avenue
Dhaka-1100
e-mail : info@jnu.ac.bd
Phone : +88-02-9534255**



**Dr. A.K.M. Moniruzzaman
Professor
Dept. of Management Studies
Jagannath University
moniruzzaman64@gmail.com
Cell : +880 1712-562578**

CERTIFICATE

This is to certify that the thesis entitled “**Industrial Relations in Ready-Made Garment Industry of Bangladesh**” being submitted by Md. Shawan Uddin, to the Department of Management Studies at the University of Rajshahi, for the award of the degree of Doctor of Philosophy, is a record of bonafide research work carried out by him. He has worked under my guidance and supervision, and has fulfilled the requirements for submission of this thesis, which to my knowledge has reached the requisite standard for the award of the Ph.D degree.

Co-supervisor

(Dr. A.K.M. Moniruzzaman)

ABSTRACT

The Ready-made Garment (RMG) sector has opened opportunities for employment to many individuals in direct and indirect economic activities that ultimately support social growth, empowerment of women and alleviation of poverty in the world. The RMG industry acts as a catalyst for the development of Bangladesh. The Made in Bangladesh tag has also brought glory for the country, making it a prestigious brand across the world. Bangladesh, which was once termed by cynics a bottomless basket, has now become a basket full of wonders. Sound industrial relations (IRs) among the four actors such as trade unions (TUs), employers, government agents (GAs) and international buyers (IBs) of RMG industry makes this basket with full of wonders. The industrial situation which is usually termed as IRs describing the functional relationships that prevail due to the interactions among the actors. This study highlights the identification of the specific actors in IRs in RMG industry of Bangladesh and their roles. This study also focuses on the relative importance of the actors in establishing a sound IRs in the sector. This study uses the strategic choice theory to measure the relationships among the roles of the actors and resultant IRs in the RMG industry of Bangladesh.

Following the pragmatism research paradigm and cross-sectional design, this study adopts a two-phase sequential mixed method research design consisting of qualitative and quantitative approaches. Findings from the qualitative method have been used to identify the roles of actors of IRs in RMG industry of Bangladesh and to develop measures and instruments for the next phase of quantitative method. In both the phases of this study, the RMG industry in Bangladesh has been studied. For study purposes 100% export-oriented RMG industries were selected. This study was conducted by using a convenience-sampling technique in both qualitative and quantitative parts. The semi-structured questionnaire was used for collecting the data in the qualitative phase through interviewing 16 participants and subsequently transcribed them by using the verbatim using the content analysis with quantitative phase. The survey method was found to be better fitting to the quantitative part of this research, and hence the questionnaire-based survey was adopted covering the number of respondents 327. The 6-point Likert scale for exogenous variables and 8 points for endogenous variable (industrial relations) were used to measure the relationships.

Seven hypotheses revealing the relationships between the various actors and state of IRs in the RMG industry in Bangladesh were tested. Out of seven hypotheses, all are accepted. The analysis of the quantitative phase revealed that there is a significant relationship between the roles of actors and the state of IRs in the RMG industry in Bangladesh. It also revealed that the roles of IBs have significant positive relations with IRs moderately mediating the roles of TUs, strongly mediating the roles of employers, and moderately influencing the roles of GAs regulating the sector under study. The study made significant contributions to both the practical and theoretical aspects of the field of IRs. This study made an important contribution to the existing IRs model originally developed by John Dunlop by integrating IBs as an another actor. This study contributes to the literature and theory of IRs through exhibiting the nature and strength of relationships among the roles of various actors and the state of IRs by using strategic choice theory. The outcome of the study will be useful to the stakeholders of the Bangladeshi RMG industry to create productive relationships among the actors involved. It also will help subside the hypothetical stigma of the dysfunctional TUs and GAs in the sector under study. Finally, this study will serve as a basis for better understanding of the intricacy of the industrial relation situations in any industry in any country across the globe.

DEDICATION

With all my respects to all actors who are working in RMG Industry

ACKNOWLEDGEMENTS

I deeply remember with great respects all who passed away by being infected with COVID 19 during the voyage of research work. I wish to express my most humble gratitude to my teacher my mother, Mrs. Shahara Shah who is my first teacher and my father Mr. Md. Aurangazeb Shah who always thinks for my betterment. My heartfelt thanks to my esteemed supervisor, Prof. Sheikh M. Nurullah, for his enormous support, compassion, reinforcement, incisive criticism, and professional wisdom. In fact, the write up of the PhD thesis would not be made possible without his continuous and persistent guidance. Simultaneously, I express my sincere gratitude to my co-supervisor Dr. A. K. M. Moniruzzaman for his valuable comments, suggestions and insights that helped me enormously to improve my work.

It is noted that it wouldn't be possible for me to go on and complete this journey without the guidance and support of my respected Prof. M. Anisur Rahman, Prof. Malay Kumer Bhowmick, Prof. Dr. A. N. M. Jahangir Kabir, Prof. Dr. Md. Zafor Sadique, Prof. Dr. Md. Ohidul Islam, Prof. Dr. Md. Faridul Islam, Prof. Dr. Md. Shah Azom, Prof. Dr. Md. Nuruzzaman, Prof. Dr. Md. Enayet Hossain, Prof. Dr. Mahbubar Rahman, Dr. Md. Atiqur Rahman Khan, Dr. Md. Shamim Hossain, Mr. Md. Salah Uddin, Mr. Amitav Saha, Mr. K. M. Sabbir Hasan, Mr. Mir Mokkaresh Ali and Mr. Samir Bhadra.

On a personal note, it would not be possible for me to go on and complete this journey without the support and sacrifice of my family members. I have to say sorry to the little angel, my daughter, Samriddhi and my wife, Nova, as it was quite impossible for me to complete this journey without their extreme sacrifice. I am indebted to my elder and younger brothers, Sumon, Shaheb and Nobin and sisters Liza, Kajol and Tupma and all other friends and relatives who had gave tremendous personal support to me in this journey. I express my heartfelt thanks to my mother and father in-law. Moreover, I convey my thanks to Mr. Md. Ishaque Ali and Mr. Sapan Mia who spent their valuable time with me during the field study.

I acknowledge the most valuable contribution of the participants who agreed to be interviewed for spending their valuable time and the hospitality they offered. I would like to pass my sincere thanks to the president of BGMEA, Bangladesh RMG Workers Federation, Director of Labor, Director of Department for Inspection of Factories and Establishments, Registrar of Trade Unions and Buying Houses, as I could not have completed this thesis if they had not stood by me. I am grateful to our little Raisa, Lamiya, Roshni, Abdullah, Raian, Aria, Sara, and Saad who assisted me during the input of the surveyed data in the SPSS software.

Finally, I apologize to anyone whom I have over sighted here, as there were many people those have contributed throughout my PhD journey.

(Md. Shawan Uddin)

LIST OF ACRONYMS AND ABBREVIATIONS USED

AVE	Average Variance Extracted
BCoC	Buyers' Codes of Conduct
BEF	Bangladesh Employers Federation
BGMEA	Bangladesh Garment Manufacturers and Exporters Association
BILS	Bangladesh Institute of Labor Studies
BJMA	Bangladesh Jute Mills Association
BKMEA	Bangladesh Association of Knitwear Manufacturers and Exporters
BLA	Bangladesh Labor Act
BLR	Bangladesh Labor Rules
BTMA	Bangladesh Textile Mills Association
CAGR	Compound Annual Growth Rate
CB	Collective Bargaining
CBA	Collective Bargaining Agent
CFA	Clearing & Forwarding Agents
CMV	Common Method Variance
CoC	Codes of Conduct
CPD	Center for Policy Dialog
CR	Composite Reliability
DFPRW	Declaration on Fundamental Principles and Rights at Work
DIFE	Department for Inspection of Factories and Establishments
DoL	Department of Labor
DOPU	Drop- off/pick-up
DR	Dispute Resolution

DWA	Decent Work Agenda
EM	Employer
EPB	Export Processing Bureau
EU	European Union
FDI	Foreign Direct Investment
FLA	Fair Labor Association
FY	Fiscal Year
GAs	Government Agents
GAAT	General Agreement on Tariffs and Trade
GDP	Gross Domestic Product
GUI	Graphical User Interface
HR	Human Resources
HRM	Human Resource Management
HRW	Human Rights Watch
HSC	Higher Secondary Certificate
HTMT	Heterotrait-Monotrait
IBs	International Buyers
ICT	Information and Communication Technology
ILC	International Labor Conference
ILO	International Labor Organization
ILU	International Labor Union
IMF	International Monetary Fund
IOE	International Organization of Employers
IRs	Industrial Relations
IRC	Industrial Relations Centre
IRS	Industrial Relations System
LC	Letter of Credit
LISREL	Linear Structural Relationships

LPT	Labor process theory
MFA	Multi-Fiber Agreement
MoLE	Ministry of Labor and Employment
MWB	Minimum Wages Board
NGO	Non-government Organizations
OA	Organizing Association
OHS	Occupational Health and Safety
PLS	Partial Least Square
PTS	Primary Textile Sector
RCC	Remediation Coordination Cell
RFP	Regulatory Framework Practice
RMG	Ready-Made Garment
RQ	Research Question
RSP	Revolutionary Socialist Party
SEM	Structural Equation Modeling
SPSS	Statistical Package for the Social Sciences
SSC	School Secondary Certificate
T & C	Textile and Clothing
TPP	Trans-Pacific Partnership
TU	Trade Union
UK	United Kingdom
USD	United States Dollar
VIF	Variance Inflation Factor
WDSRN	Worker Driven Social Responsibility Network
WE	Working Environment
WPC	Workers Participation Committee
WTO	World Trade Organization

CONTENT

Declaration	i
Certificate	ii
Certificate	iii
Abstract	iv
Dedication	vi
Acknowledgements	vii
List of Acronyms and Abbreviations used	ix
CHAPTER ONE	
INTRODUCTION	1
1.1 Introduction.....	1
1.2 Background of the Study.....	1
1.3 Problem of the Study	9
1.4 Research Questions.....	11
1.5 Research Objectives.....	11
1.6 Significance of the Study	12
1.7 Key Concepts and Terminologies used	16
1.8 Thesis Layout	18
CHAPTER TWO	
LITERATURE REVIEW	20
2.1 Introduction.....	20
2.2 RMG Industry in Bangladesh.....	20
2.2.1 Historical Changing Pattern of RMG Industry in Bangladesh.....	21
2.2.2 Present Scenario of RMG Industry in Bangladesh	26
2.2.3 Problematic Aspects of RMG Industry in Bangladesh	35
2.2.4 Prospects of RMG Industry in Bangladesh.....	37
2.3 Industrial Relations	39
2.3.1 Different Actors of Industrial Relations	43
2.3.1.1 Trade Unions.....	44
2.3.1.2 Employers	51
2.3.1.3 Government Agents	55
2.3.1.4 International Buyers	61

2.4 Indicating aspects of the Roles of Actors in RMG Industry	65
2.4.1 Regulatory Framework Practices	65
2.4.2 Working environment	68
2.4.3 Organizing association	69
2.4.4 Collective Bargaining	71
2.4.5 Dispute Resolution	72
2.4.6 Buyers' Codes of Conduct.....	73
2.5 Industrial Relations in RMG Industry of Bangladesh	74
2.6 Research Gap	79
2.7 Conclusion	80

CHAPTER THREE

THEORETICAL PERSPECTIVE AND HYPOTHESES DEVELOPMENT ..	81
3.1 Introduction.....	81
3.2 Reviewing of Related Theories in the Research Area	81
3.2.1 Unitarist Theory of Industrial Relations	82
3.2.2 Scientific Management Theory	83
3.2.3 Human Relations School Theory	83
3.2.4 Human Resource Management Practices Theory	84
3.2.5 Pluralistic Theory	84
3.2.6 Labor Process Theory	85
3.2.7 Agency Theory	86
3.2.8 Legitimacy Theory	87
3.2.9 Stakeholder Theory	87
3.2.10 Strategic Choice Theory.....	88
3.3 Underlying Theory.....	89
3.4 Existing Research Model.....	94
3.5 Conceptual Framework.....	95
3.6 Hypotheses Development	97
3.6.1 Trade Unions and Industrial Relations	97
3.6.2 Employers and Industrial Relations	99
3.6.3 Government Agents and Industrial Relations	100
3.6.4 International Buyers and Industrial Relations	101
3.6.5 Mediating effects of the roles by TUs, employers and GAs to explain the relationships between IBs and IRs in RMG industry of Bangladesh.	103
3.7 Conclusion	105

CHAPTER FOUR

RESEARCH METHODOLOGY	106
4.1 Introduction.....	106
4.2 Research Paradigm.....	106
4.3 Research Methods.....	110
4.4 Qualitative Field Study Method	113
4.4.1 Interview questionnaire development.....	114
4.4.2 Sample selection	115
4.4.3 Data collection	117
4.4.4 Data analysis.....	117
4.4.5 Results and Interpretations	118
4.4.5.1 Constructs and Items	118
4.4.5.2 Cross-examination of conceptual model.....	131
4.5 Conceptual Model.....	132
4.6 Quantitative Study Method	134
4.6.1 Research Design	135
4.6.2 Sampling Technique and Sample Size	135
4.6.2.1 Sampling Technique	135
4.6.2.2 Sample Size.....	136
4.6.3 Questionnaire Development.....	137
4.6.3.1 Instrument Development	139
4.6.3.2 Questionnaire section A: Demographic measures	140
4.6.3.3 Questionnaire section B: Measuring Roles of Actors in Industrial Relations.....	140
4.6.3.3.1 Trade unions	141
4.6.3.3.2 Employers	142
4.6.3.3.3 Government Agent.....	143
4.6.3.3.4 International Buyers.....	144
4.6.3.3.5 Industrial Relations	145
4.6.3.4 Demographic Information	147
4.6.3.5 Pre-Test.....	148
4.6.3.6 Pilot Test.....	148
4.6.4 Data Collection Procedure	150
4.7 Data Preparation	151

4.7.1 Missing Data	151
4.7.2 Data Distribution (Treatment of Normality and Non-Normality)	152
4.7.3 Common Method Variance	153
4.7.4 Data Analysis Technique	153
4.7.5 Model Specification	154
4.7.6 Reflective and Formative Measurement Models	155
4.7.7 Outer Model Evaluation Indicators	158
4.7.8 Convergent Validity	159
4.7.8.1 Indicator Reliability.....	159
4.7.8.2 Composite Reliability	159
4.7.8.3 Average Variance Extracted.....	160
4.7.9 Discriminant Validity	160
4.7.9.1 Discriminant Validity (Fornell and Larcker).....	160
4.7.9.2 Discriminant Validity (HTMT)	160
4.7.10 Inner Model Evaluation	161
4.7.10.1 Notion of Coefficient of Determination.....	162
4.7.10.2 Predictive Relevance.....	162
4.7.10.3 Effect size.....	162
4.7.11 Multicollinearity	163
4.7.12 Path Coefficient	163
4.8 Data Analysis Tools	163
4.8.1 Statistics Package for Social Science	163
4.8.2 Smart Partial Least Square 3.0	164
4.9 Conclusion	164

CHAPTER FIVE

SURVEY AND QUANTITATIVE DATA ANALYSIS	165
5.1 Introduction	165
5.2 Response Rate	165
5.3 Profile of Respondents	166
5.4 Common Method Bias/Variance	167
5.5 Descriptive Statistics of the Items	169
5.6 Goodness of Measurement Model	170
5.6.1 Convergent Validity	170

5.6.2 Discriminant Validity	171
5.6.2.1 Fornell and Larcker Criteria	172
5.6.2.2 Heterotrit-Monotrait Ratio.....	172
5.7 Multicollinearity	173
5.8 Inner Model Evaluation	174
5.8.1 Analysis of Predictive Relevance	175
5.8.2 Coefficient of Determination	175
5.8.3 Effect Size	176
5.9 Summary of Path Coefficient and Hypothesis Testing	177
5.10 Conclusion	177
CHAPTER SIX	
DISCUSSION, CONCLUSION AND FUTURE RESEARCH AGENDA	178
6.1 Introduction.....	178
6.2 Findings of the Study.....	178
6.2.1 Relationship between Trade Unions and Industrial Relations.....	178
6.2.2 Relationship between Employers and Industrial Relations.....	179
6.2.3 Relationship between Government Agents and Industrial Relations...	180
6.2.4 Relationship between International Buyers and Industrial Relations .	181
6.3 Implications of the Study	182
6.3.1 Theoretical Implications	182
6.3.2 Practical Implications.....	184
6.4 Recommendations.....	184
6.5 Limitations of the Study.....	186
6.6 Further Research Agenda.....	187
6.7 Conclusion	187
Bibliography	189
Appendix-A	243
Appendix-B.....	249
Appendix C.....	260
Appendix D.....	263

LIST OF TABLE

Table 2.1: Some Recent Incidents in RMG industries of Bangladesh	33
Table 2.2: Literature about Industrial Relations.....	41
Table 2.3: Literature about Trade Unions and Industrial Relations.....	47
Table 2.4: Literature about Trade Unionism in RMG of Bangladesh.....	50
Table 2.5: Literature about Employers and Industrial Relations.....	53
Table 2.6: Literature about Government Agents in Industrial Relations and RMG of Bangladesh.....	59
Table 2.7: Literature about International Buyers in RMG	64
Table 2.8: Literature about IRs in RMG of Bangladesh	76
Table 3.1: Industrial Relations Strategy Matrix.....	91
Table 3.2: Summary of the Key Literature on Industrial Relations Theories.....	92
Table 4.1: Research Paradigm.....	107
Table 4.2: Qualitative and Quantitative Research Methodology	113
Table 4.3: Field study interview participant’s profiles	116
Table 4.4: Construct and Items of Industrial Relations in RMG of Bangladesh	126
Table 4.5: Constructs and corresponding opinion	131
Table 4.6: Constructs, sub-variables and links with the Industrial Relations.....	132
Table 4.7: Measurement of Demographics.....	140
Table 4.8: Research Measurement Instrument.....	141
Table 4.9: Items relating to Trade Unions.....	142

Table 4.10: Items relating to Employer	143
Table 4.11: Items relating to Government Agent	144
Table 4.12: Items relating to International Buyers	145
Table 4.13 Items relating to Industrial Relations	146
Table 4.14: The Demographic Questionnaire	147
Table 4.15: Summarizes the Internal Consistency Reliability for Each Measure	149
Table 4.16: A Framework For Assessing Reflective and Formative Models: Theoretical and Empirical Considerations.....	156
Table 5.1: Response Rate	165
Table 5.2: Descriptive Analysis of Demographic Data of the Respondents	166
Table 5.3: Total Variance Explained	168
Table 5.4: Descriptive Statistics of the indicators.....	169
Table 5.5: Results of Measurement Model	171
Table 5.6: Discriminant Validity of Constructs-Fornell-Larcker Correlation Check	172
Table 5.7: Heterotrit-Monotrait Ratio Criteria.....	172
Table 5.8: Variance Inflation Factor and Remarks	173
Table 5.9: Predictive Relevance of the Constructs	175
Table 5.10: Coefficient of Determination	175
Table 5.11: Effect Size	176
Table 5.12: Summary of Hypotheses	177

LIST OF FIGURE

Figure 1.1: Bangladesh RMG Export Market	5
Figure 1.2: Contribution of RMG to GDP of Bangladesh	6
Figure 2.1: Number of RMG Factories in Bangladesh	27
Figure 2.2: RMG Price Movements in Bangladesh	28
Figure 2.3: Bangladesh RMG Export Market by Process Type	29
Figure 2.4: Bangladesh RMG Export Market by Garment Type.....	30
Figure 2.5: Bangladesh Woven Export Market	31
Figure 3.1: Existing Research Model	94
Figure 3.2: Conceptual Research Framework	96
Figure 4.1: Mixed Methodology	111
Figure 4.2: Model Indicator	155
Figure 4.3: Outer Model Indicator.....	158
Figure 4.4: Inner Model Evaluation.....	161
Figure 5.1: Measurement Model	174

CHAPTER ONE

INTRODUCTION

1.1 Introduction

This chapter presents the introduction of the research by highlighting the background, problem statement, research questions and objectives of the study. It also deals with the significance of the study, definition of key terms, and the layout of the thesis.

1.2 Background of the Study

The continuously increasing demand for cloth leads to the development of the cloth industry (Khatri, Peerzada, Mohsin & White, 2015). Industrialization is often vital for economic growth, and poverty alleviation (Sittha, 2012). Globalization has distorted the competitive periphery of nations, firms, and industries (Gereffi, 1999). The need for achieving high efficiency the labor concentrated industries will relocate to those nations where there have cheapest labor availability with a plentiful stockpile of input materials for manufacturing such a product. Cloth making is a quintessential case of such an industry (Taplin & Winterton, 2004).

Increasing urbanization, increasing disposable income and a growing middle class led to higher spending on ready-to-wear clothes, leading to regular purchases of clothes such as fast fashion (Taplin & Winterton, 2004). This has resulted in a rise in the amount of garments treated on the aftermarket (O'Reilly & Kumar, 2016). The use of cheap labor has become an omnipresent characteristic of the textile and apparel industries, rendering them to produce and assemble garments local and global scales at the same time (Taplin & Winterton, 2004). The increased production of Ready-made Garment (RMG) goods generates employment for lots of peoples (Dickens & Hall, 2003).

Continuous supply of necessary goods and services are guaranteeing economic survival and life through capital and labor (Huws, 2014). However, the issue is that the interests of human factors involves in the development process frequently contradict one after another. The employees demand for equity in wages and better working conditions. Whereas, the owners demand maximum profit (Meade, 1972). Moreover, still there is a tussle between

these two factors (Ahmed & Nathan, 2016). Industry refers to any successful operations whereby individual work together to achieve predetermined goals and objectives (Sisson, 2008; Walby, 2013). Relationships develop when people work together for the purpose of production in a cooperative way (Hom, Tsui, Wu, Lee, Zhang, Fu & Li, 2009).

The conflict of interest is real and imagined which gives rise to an adverse relationship resulting in separation between them (Clews, Hatch & Elkins, 1886). Employers view the employees as a pure production tools, the workers find employers to be exploiters (Clark, 2009). This alienates employers and employees who are the pair comprising a fundamental part of every successful operation. This dissatisfaction leads to employees' disputes, low productivity, increasing inefficiency and so on (Bélanger & Edwards, 2007).

Industrial relations (IRs) essentially is the product of economic relations emanating from the process of hiring out employees' services for earning money (Kaufman, 2013). Therefore, the relationships among trade unions (TUs), employers, and government agents (GAs) in industry determine the IRs (Hyman, 1975) in a particular industry. IRs means the relationship between employers and employees where employers are comprised of the proprietors and administrative staff members working on behalf of the employers (Blyton & Turnbull, 2004). GAs is regarded as the third actor in IRs (Hyman, 1975). Moreover, the industries abide by the rules, guidelines, and obligations imposed by the international buyers (IBs) and accomplish the necessities set by the IBs in its daily operations, including the maintenance of a particular working environment, manufacturing of goods following prescribed standards, and shipping goods of following the codes of conduct (CoC) set by the IBs and GAs (Hossain & Arefin, 2015).

In industrial relations, IBs is the most powerful among sellers or producers. IBs persuade RMG employers to develop workplace environments for their factories (Hossain & Arefin, 2015). Therefore, industrial growth, sustainability, productivity, and prosperity depend on the good relationship among the actors such as TUs, employers, GAs (Hyman, 2008) and IBs (Hossain & Arefin, 2015). In other words, good IRs means industrial harmony, which is vital for better and higher outputs (Arumugam & Balasundaram, 2010; Hyman, 1975; Kelly, 2012).

Employers and TUs need harmonious relationships to assure both of their interests in production (Foster & Rasmussen, 2010). Employers maintain the conducive relationship with the employees because each organization has its key function of preventing conflict to occur and of resolving the conflict when occurred as soon as possible to ensure sound IRs and higher productivity (Kochan, Lansbury & Verma, 1995; Oswald, Proto & Sgroi, 2015). On the other hand, strong IRs implies employee harmony, which is vital, required for better and higher output. IRs covers an assurance of equal wages and working environment (Robinson & Zhang, 2005). In every industry, IRs and employee relationships are clearly two important elements with IRs depending on the roles of employees (Khan, 2010).

Autonomy, job security, and freedom are the fundamental needs of industrial employees (Rönmmar, 2019; Zhou & Gong, 2019). In addition, the employees' perquisites also include adequate food, health and safety, clothes and accommodation (Sugihara, 2013). A situation where employees are happy with his work, confident of a promising future and provided with necessities to satisfy their needs deems to imply an atmosphere of healthy IRs (Aziri, 2011; Lund, 2003). IRs has several roles in developing industry in every country; two main goals of sound IRs are to sustain industrial peace and safe industrial operations (Lester, 2015; Sivarethinamohan, 2010). Effective IRs in an industry can help to achieve growth and progression of the industry by adhering to democratic processes, and thereby ensuring prosperity, employees' well-being and satisfaction, and industrial peace (Arumugam, & Balasundaram, 2010; Richardson, 2013).

John Dunlop (1958) introduced the word actor in IRs in his landmark work on Industrial Relations Systems (IRS). John Dunlop denoted that actors combined of three groups such as employers, TUs and GAs working together; the actors may engage in conflict over their respective interests (Hak-Soo, 2010). According to Dobson (1982), to have harmonious relationships among the actors of a peaceful working environment in the industry, it needs to diagnose, articulate and resolve the conflict. Employers, TUs and GAs deal IRs problems and thus promote harmonious working relations among them (Ackers, 2014; Hyman, 2013; Kaufman, 2012).

Among the three actors, employers who possess certain rights vis-a-vis employees and hire them (Hanami, 2013); employees who seek to improve the terms and conditions of their employment (Ethical Trading Initiative, 2010); GAs control and govern employee relations through laws, regulations, settlements, court awards (Hyman, 2008) and the like and TUs is to represent workers; however, they have a wider role of protecting the interests of employees (Bellemare, 2000).

New model of IRs is to be developed taking into account the interest of all actors in the industry such as manufactures, management, middle man (Buying house), and enthusiasm of agents, the workers cutting and processing force, strategic edge force, the crucial elements in the manufacture of apparel, subsisting strength of the RMG industry (Haq, 2018). The new types of IRs included another actor that is the buyers (Hicks, Sappey, Basu & Burgess, 2009; Nuruzzaman, 2013). IBs are the most impressive members of RMG industry dealing with more strongly than sellers or fabricators (Hossain & Arefin, 2015). When manufactures refuse to provide garments according to the specifications of customers, sellers have to incur tremendous financial losses including the lose of credibility at the market place (Keiser, Garner & Vandermar, 2017).

The international buyers may have the requirements that must be fulfilled not only when shipping to the IBs but also when preparing product for them (Hossain & Arefin, 2015). Buyers' CoC have changed along with the price and nature of the goods (Carballo-Penela, Mateo-Mantecón, Alvarez & Castromán-Diz, 2018; Nurruzaman, Haque & Azad, 2016; Rahman, Habibullah & Masum, 2017). At present, the IB is another actor who is playing a vital role in maintaining a safe working environment including employee health and safety (Cooperative, 2017; Hasan, 2018).

The countries like China, India, Korea, Hong Kong, Malaysia; Indonesia, Pakistan, Vietnam, Cambodia, Taiwan and others are highly renowned and competitive in this sector until the early eighteen of the nineteen century (Morris & Staritz, 2017). Like these countries, the RMG of Bangladesh is the second biggest exporter industry in the world after China (Hosen, Elahi, Nizam, Ali & Shifat, 2019). Therefore, this is imperative to maintain an amicable IRs in RMG industry in Bangladesh. The RMG industry of Bangladesh is still remaining competitive globally for its low cost workforce and has

achieved remarkable market share and occupied the 2nd position based on the amount of foreign currency earnings it makes through exporting of its garment products (Mohibullah, Hosen, Abir, Takebira, Jannat & Shakil, 2018). The dynamism of the RMG sector in Bangladesh serves as a boost for the nation's growth and creating brand reputation at the global level (Abdullah & Islam, 2018).

Ready-made Garment in Bangladesh has been selected for this study because it is considered to be one of the firmest and fastest manufacturing sectors in Bangladesh (Hossain, Kabir & Latifee, 2019) and also regarded as the biggest export earning industry in our country (Alam, Selvanathan & Selvanathan, 2017). Apart from its contribution as an export earning industry, the RMG industry is playing an important role in employment generation, poverty alleviation and empowering of women (Ansary & Barua, 2015). In fiscal year (FY) 2018-19, RMG earned more than 35 billion United States Dollar (USD) which is the 84.21% of the total export (Anner, 2020; EPB, 2019; Hossain et al., 2019). The remarkable growth of this sector starts from the 1970s and until now, it keeps growing (Adnan, Khan & Islam, 2019; Hasan, Hossain, Alam, Chowdhury, Al Karim & Chowdhury, 2018; Sytsma, 2019). Following figure, 1.1 shows the export market of RMG industry of Bangladesh in the world.

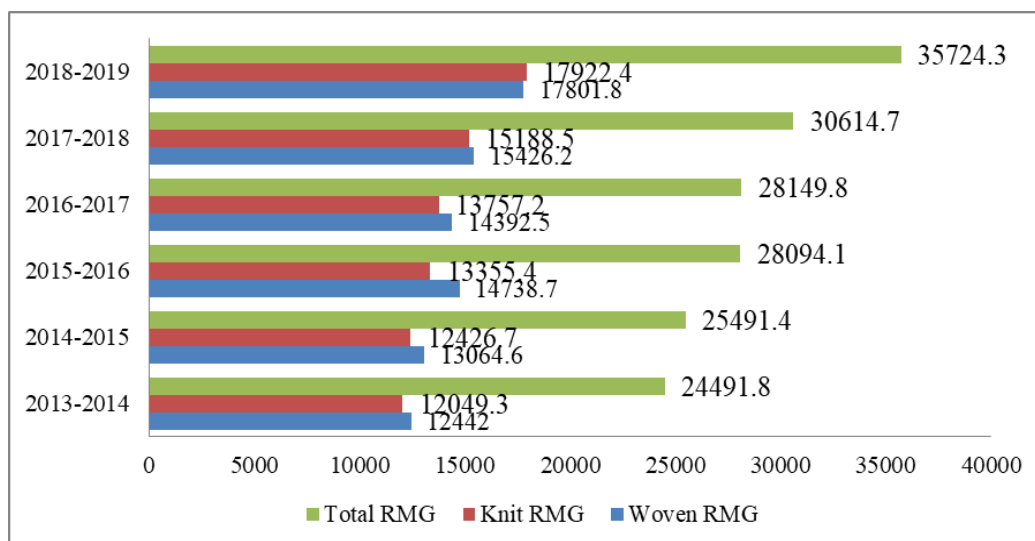

Figure 1.1: Bangladesh RMG Export Market (USD in millions)

Source: BGMEA, 2019

The above figure shows that in FY 2013-14 the total export of RMG was USD 24491.8 millions comprising woven wear export of USD 12442 millions and knit wear export of USD 12049.3 millions. The trend of the export is seen to be rising over years. In the FY 2018-19 the total export in RMG sector is USD 35,724.3. In the FY2018-19, the expected export will be USD 33,402.8 millions where the forecasting of export in the FY 2020-21 will be USD 38984.9 millions.

The RMG sector of Bangladesh plays a vital role in the development of its economy (Alam, Alias & Azim, 2018). It is significantly contributing to the gross domestic product (GDP) of the country (Alamgir & Banerjee, 2019). However, the recent information on the contribution of this sector is somewhat alarming due to the fact that the growth in RMG sector in Bangladesh declined over the last five years due to lack of product diversification and lethargic private investment (Raihan & Khan, 2020). According to the Bangladesh Garment Manufacturers and Exporters Association (BGMEA) data 2019, the contribution of RMG to GDP came down to 11.17% in the FY 2017-18, which was 14.17% in FY 2013-14, down by 3%. In the last FY 2018-2019, the contribution was also going downwards by 0.74%. The following figure 1.2 shows the recent contributions of RMG sector to GDP of Bangladesh.

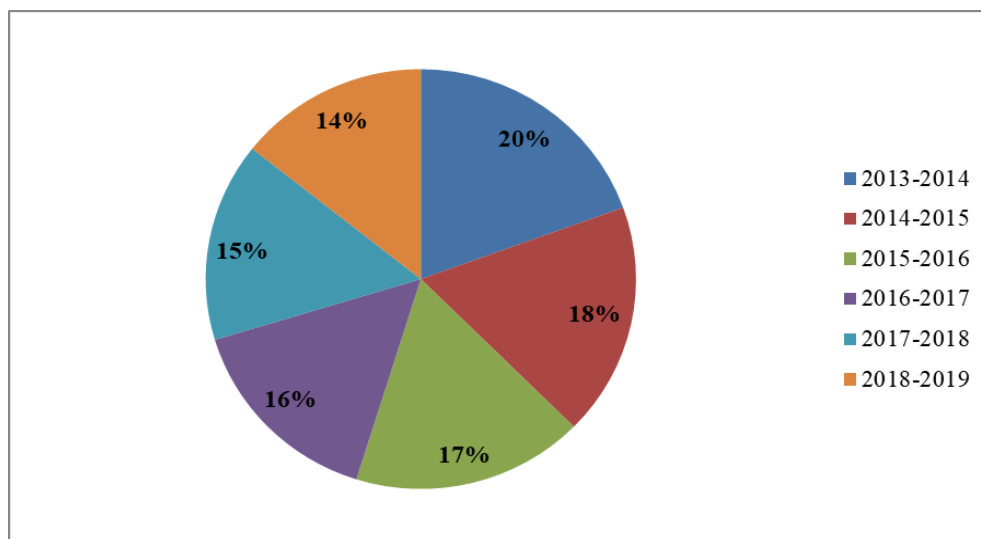

Figure 1.2: Contribution of RMG to GDP of Bangladesh

Source: BGMEA, 2019

The figure 1.2 shows the contribution of RMG to the GDP of Bangladesh where it shows that in the FY 2013-14, the RMG made the highest contribution of 20% but afterwards the trend was downward. In the FY 2018-19, the contribution was the lowest among the all the contributions this sector made in each of fiscal year during the 6-year period as shown in the figure.

The actors in RMG sector must discern the importance of ensuring a sound working condition for the workers because the performance of the workers is greatly influenced by the working condition (Hossain et al., 2019). The industrial situation of RMG is usually termed as IRs describing the functional relationships that prevail due to numerous of interactions among employers, TUs, GAs and IBs.

This study highlights the identification of the specific actors in IRs in RMG industry of Bangladesh and their roles. This study also focuses on the relative importance of the actors in establishing a sound IRs in RMG of Bangladesh. Moreover, this study measures the relationships among the roles of the actors and IRs in the sector under study. It also measures the relationships of the roles of IBs with IRs amidst the mediating roles of TUs, employers and GAs. Actors of the IRs and their tasks can be found and evaluated on distinct levels, described by the strategic choice theory (Kochan, McKersie & Cappelli, 2002). Such theory expresses the concept about the job that cannot be limited to the factory floor, rather involves the whole factory as well as the wider societal, economical, and legal context that governs particularly employee relations (Kochan, 2004). The philosophy of strategic choice theory points out the following areas for analysis: organizing union, strategic human resource management (HRM), policies and laws, corporate campaign with workers rights (Kochan, Katz & Capelli, 1984, p. 23). To identify the actors and their roles in IRs in RMG industry of Bangladesh and to measure the relationships between the roles of the actors, this study was conducted using the mixed-method based on the perceptions of participants and respondents in creating a desired IRs.

Most of the studies such as Deery, Iverson and Erwin (1999), Dickens (2000), Ghosh and Ray (2012), Gupta (2014), Nowak (2015), Parashar and Thakur (2018), Treu (2013)

considered the debate about the role of TUs in IRs situations, and about bargaining with employers to ensure that employees have decent working practices, equal pay, job security. Some studies showed the roles of employers in the IRs including minimum wages for RMG employees, the acceptance of TUs activity, the issuance of letters of appointment and identification cards to staff, the setting of working hours and the promise of maternity leave and other holidays (Al Faruque, 2009; Bakht & Hossain, 2017; Hossain, Ahmed & Akter, 2010; Hossain & Akter, 2015; Siddiqua, Chowdhury & Islam, 2014; Yunus & Yamagata, 2012).

Many studies regarding the roles of GAs in the IRs like Hyman (2013), Masters, Gibney, Shevchuk and Zagenczyk (2008), Martínez Lucio and Stuart (2011), Kelly (2012), Salamon (2000) showed that on behalf of the Government, GAs have tried to regulate IRs through laws that regulate the formation and activities of TUs and laws that regulate the general as well as work-related interactions between workers and their TUs on the one hand and employers on the other. Some studies (Alam et al., 2018; Ansary & Barua, 2015; Azim, Alam & Alias, 2017; Hasan, Islam & Arifuzzaman, 2015; Ullah, Sunny & Rahman, 2013) have addressed almost all international RMG buyers to focus on labor rights based on buyers' CoC as social compliance to be met in RMG factories which is one of the basic key requirements for sound IRs.

Moreover, study by Sharma (2015) explained the reflection of the effectiveness of Bangladesh Labor Act (BLA) for strengthening country-working condition. Afrin (2014) analyzed the labor rights and privileges of employees in Bangladesh's RMG industry by evaluating the existing state of jobs in the RMG industry based on core labor standards of the International Labor Organization (ILO). Ferdous (2011) investigated the current situation, examined working conditions in the Bangladesh RMG sector, and analyzed the roles of the actors in IRs systems. Evaluation of the recent record of working conditions indicates persistent problems that are associated with Bangladesh's export niche and underscores the urgent need to move to a higher productivity export structure that would enable higher wages, improvements in working conditions, and overall gains in well-being.

Al-Amin and Hoque (2015); Habibur and Siddiqu (2015) studied on the real situation in light of which several recommendations were made by them to ensure the protection of the employees in the RMG industry of Bangladesh. Study by Shrestha (2012) examined how trade unionism affects employees. Nwokocha (2015) mentioned in his study that conflict is unavoidable in all organizations, and as such, managers responsible for executing new management strategies to accomplish business goals must play a decisive role in maintaining workplace peace.

1.3 Problem of the Study

RMG sector holds leading position in terms of its contribution to the economy of Bangladesh (Adnan, Rakib & Rahman, 2015; Gaffar Khan, Ul Huq & Islam, 2019; Islam, Jantan, Hashim, Chong & Abdullah, 2018; Islam & Haque, 2018). Sound IRs, among others, is very important condition for ensuring a productive RMG sector and a sustained growth, and it can be made possible through maintaining harmonious interactions and relationships between the actors involved in the IRs process (Al Faruque, 2009; Rahman & Kashem, 2017). It is mentioned earlier by John Dunlop (1958) that identified employers, TUs, and GAs are the actors in a modern IRs. The export trade in Bangladesh is mostly driven by the RMG industry (Razzaue, Eusuf & Shamannay, 2007). Therefore, the IBs are the important actors to promote such exports (Islam & Haque, 2018).

Working with each other, the actors come into conflict over their respective interests (Rose, 2004). The BLA 2006 and its amends in 2013; 2015 and 2018 are applying in the field of IRs of Bangladesh covering the roles of the actors in IRs (Al Faruque, 2009; Mia, 2016). The actors in IRs are playing their roles in RMG industry in Bangladesh to give rise to a harmonious and tranquil working environment in the industry (Kabir, Singh & Ferrantino, 2019). Employers are legally responsible for triggering the working practices including the enforcement of labor laws and any disciplinary action affecting the employees (Moss & Tilly, 2001; Venn, 2009). Employers have the opportunity to improve the overall efficiency through ensuring effective communication process. They also deal with the issues of their own relating to IRs including the bargaining over the terms and conditions of employment, which have effect on the enhancement the IRs (McCleary, Goetzl, Roemer, Berko, Kent & Torre, 2017).

Trade union is an organization of workers (Headey, 1970; Stansbury, 2008) bargains on behalf of union members with the employer and negotiates labor contracts with employers (Ewing, 1984; Farber, 1986). It is the core party to IRs (Hyman, 2007). Such forum is traditionally formed to protect their members' interests and to defend themselves against the injustices, exploitations and abuses by their employers (Taher, 1999; Thompson, 2016) and thereby attempting to maintain check and balance in the IRS.

Government agents as the significant actors play roles of umpires, conciliators, arbitrators and administrators influencing the IRs (Al Faruque, 2009; Badejo, 2014). GAs play a central role in the intervening and shaping the IRS by formulating, governing and controlling laws, regulations, settlements, court awards (Badejo, 2014; Howell, 2005; Hyman, 2008). It implements and systematizes structural reform through a collection of specific public capacities; narrating an objective analysis of the crisis in IRs; solving the joint action problems of employers, unions and buyers; and predicting and establishing relationships among IRs and actors (Davies & Freedland, 2007).

International buyers are the most effective actors of RMG in the sense that they can force the RMG enterprises in Bangladesh into following compliances set by them (Hossain & Arefin, 2015). Compliance with IBs is an important requirement for the success of the RMG manufacturers (Alamgir & Banerjee, 2019; Tarannum & Ansary, 2018) which helps enforce occupational health, safety and welfare, the right to association and collective negotiation, issuance of letters of employment and fixing of minimum wage rates for the RMG employees, conducive structural regulations for boosting harmonious relations in the sector under study (Hasan, 2018; Latifee, 2016).

Bangladesh has strong legislative structures for labor, working environment and IRs (Berik & Rodgers, 2010). Past studies explored a number of actors or players contributing to improvement of overall IRs process in RMG in Bangladesh. However, the specific roles of these actors in IRs are not well documented. The RMG sector in Bangladesh still suffers from poor working conditions, negligence of labor rights and weak enforcement of laws. In the present context, a number of actors can be observed to be playing important role in IRs but it is not clear about the extent of role each of these players play in the said system. There is also no consensus on the relative importance of the actors in establishing a sound IRs in RMG of Bangladesh. The previous literature did not have study embodying any well-accepted theoretical framework to address the intricacy of IRs situation in RMG industry in Bangladesh.

1.4 Research Questions

Based on the objectives of this study, the following research questions (RQ) have been attempted to investigate:

RQ1. Who are the actors influencing IRs in RMG industry of Bangladesh?

RQ2. What kinds of relationships are there between the roles of TUs and IRs in RMG industry of Bangladesh?

RQ3. What kinds of relationships are there between the roles of employers and IRs in RMG industry of Bangladesh?

RQ4. What kinds of relationships are there between the roles of GAs and IRs in RMG industry of Bangladesh?

RQ5. What kinds of relationships are there between the roles of IBs and IRs in RMG industry of Bangladesh?

RQ6. How do initiatives of TUs, employers and GAs intervene the relationships between the roles of IBs and IRs in RMG industry of Bangladesh?

RQ7. Do there exist any other factors influencing the relationships among the actors involved and the state of IRs?

1.5 Research Objectives

The main objective of this study is to measure the relationships among the actors and their influences on determining the state of IRs in the RMG industry in Bangladesh. The specific objectives of the present study include the following:

1. To identify the actors active in the maintenance of IRs in RMG industry of Bangladesh.
2. To measure the relationships between the roles of TUs and IRs in RMG industry of Bangladesh.
3. To measure the relationships between the roles of employers and IRs in RMG industry of Bangladesh.
4. To measure the relationships between the roles of GAs and IRs in RMG industry of Bangladesh.
5. To measure the relationships between the roles of IBs and IRs in RMG industry of Bangladesh.
6. To measure the mediating effects of the initiatives by TUs, employers and GAs to explain the relationships between IBs and IRs in RMG industry of Bangladesh.

1.6 Significance of the Study

The industrial development process propels the economic growth in Bangladesh offering high-wage jobs to large numbers of employees and thereby increasing social productivity through mass-production of high-value products (Islam, Rakib & Adnan, 2016). The role of the RMG industry in the field of industrialization is very prominent in both developed and developing countries (Akterujjaman, 2013; Rakib & Adnan, 2015). The economy of Bangladesh offers a unique competitive advantage based on cheapest labor and low cost land and utility, which encourages productive expansion into new strategic markets (Hoshen, 2014). The RMG industry is the main export-earning sector of Bangladesh, ranging from spinning to weaving, from knitwear to leisurewear, and high stitching fashions (Gaffar et al., 2019; Islam et al., 2018). RMG industry is still playing a significant part in the industrialization and economic development cycles (Hasan, Mia, Rahman, Ullah& Ullah, 2016).

By exploiting an isolated market under General Agreement on Tariffs and Trades (GATT) Multi-Fiber Agreement (MFA), it achieved a lofty profile earlier in terms of foreign exchange earnings, exports, industrialization, and GDP contribution within a short period of time (Rahman & Siddiqui, 2015). This industry has contributed to generate huge number of employment opportunities mostly for the poor illiterate female workforce of the country, enhancing the socio-economic prospects, (Mohibullah et al., 2018). Bangladesh's RMG are manned and driven by young and urbanized workers (Ahamed, 2013).

The Ready-made industry has provided employees from rural areas with job opportunities who historically had little ability to be part of the formal workforce (Saha & Islam, 2017). Exports from Bangladesh are highly concentrated in the RMG area, which has a role in poverty alleviation (Ahmed, 2009). RMG is the leading export oriented industrial sector of Bangladesh and it seems to be the major industry in future. In FY 2018-2019, of the total export made from the Bangladesh, more than 84% was from RMG (EPB, 2019). Since then the growth in export of RMG was found to be steady, which showed a sign of competitive advantage the sector has over its competitors (Sytsma, 2019).The RMG has been gaining double-digit growth despite government's projection of single digit, which was a positive sign too (Mia & Akter, 2019).

The Ready-made sector has been selected for this study because of its firmest and fastest growth fetching biggest volume of foreign currency. Apart from this, it is contributing to the country economy by generating huge employment opportunities and thereby alleviating poverty and empowering women. RMG producers make heavy use of Clearing & Forwarding Agent (CFA) service facilities for custom clearance of inputs and finished products. Port use fees received from the RMG businesses are projected to account for more than 40% of the port authority's earnings (Rahman & Chowdhury, 2020). The RMG sector contributes to the government exchequer both directly and indirectly (Khan, 2010). The sector paid a significant amount of USD as stamp and postage, license renewal fee etc. The sector also pays a huge amount to the government as direct taxes (Rabby, 2019).

Moreover, Ready-made industry contributes to the technology sector through making payments to various services relating to electrical engineering, transport vehicle maintenance, repairing and maintenance, and machine tools services (Argyrou, 2014). The RMG sector is also playing a catalytic role in the growth of Information and Communication Technology (ICT) industry in the region. The resources used by the RMG industry help produce increased revenue for the ICT sector. The various types of payments for ICT services made included networking, hardware, and electronic facilities, and the total amount of payments for such services was projected at large dollars in the FY2019-2020 (Revathi & Aithal, 2019).

Besides, the RMG is promoting the growth of related ancillary small-scale businesses as well (Masum, Fakir & Hussain, 2017) like the goods of dyeing, printing, zippers, labeling. This small-scale was started on a limited scale but now it is expanding dramatically. This sector stimulated the growth of the weaving, spinning, dyeing, and finishing industries. It also manufactures the accessories and spare parts. However, still it is making substantial environmental impacts by contributing to economic as like banking, insurance, real estate, retail, hotels and tourism, recycling, consumer goods utility services and transport (Sarkar, Anjum & Khan, 2017). Moreover, this sector has direct and high linkage with the textile sector, which supplies fabrics, yarns and other ancillaries (Shimu & Islam, 2018). It also has noteworthy relations with services like power, gas and supplies machinery and spare parts (Nahar, 2019).

The Ready-made industry in Bangladesh proved as a successful industry, which is a vehicle for further industrialization of the nation (Adnan et al., 2015; Mia & Akter, 2019). In contrast, various protests against the Bangladeshi RMG enterprises for the abuse of human rights causing injuries and deaths of workers have been receiving the attention of foreign media and non-government organizations (NGOs) (Rahman & Chowdhury, 2020). Such kinds of acts and events potentially had a negative effect on the Bangladesh RMG industry (Ansary & Barua, 2015). In recent years, aggressive labor unrest and the large-scale death of workers caused by fires and other accidents have put the export-oriented RMG industry of Bangladesh under the spotlight (Mamun & Griffiths, 2020). Several labor unrests took place in a bid to press the demand for wages enhancement and ensuring adequate safety and security measures at the workplace (Akhter, Salahuddin, Iqbal, Malek & Jahan, 2019).

Though Bangladesh has been quite successful in ensuring safe and healthy work environment and conditions for the factory workers in the RMG industry (Kurpad, 2014), Bangladesh has relatively organized legislative structure for IRs (Berik & Rodgers, 2010). The BLA 2006 and its amends in 2013, 2015 and 2018 are being applied in the field of IRs of Bangladesh covering the roles of the actors in IRs (Al Faruque, 2009; Mia, 2016). Nevertheless, the sector has been suffering from poor working conditions, negligence of labor rights and weak enforcement of the regulations (Ahmed & Nathan, 2016; Saha & Mazumder, 2015; Siddiqua et al., 2014). There are labor laws and legislations affecting and shaping the state of IRs in all sectors irrespective of their differences in nature except for RMG, which was lacking similar legislative arrangements. The RMG sector is suffering from a lack of proper roles of actors in the issue of IRs due to the absence of proper legislative measures (Ahamed, 2013). The absence of legislative measures has put the IRs in the RMG industry in Bangladesh under a rigorous scrutiny with a view to finding out a proper way the various actors involved should be playing their roles (Mausumi & Rahman, 2018). The IBs also express their serious concerns over the workplace environment, particularly, compliance issues relating to labor standards and workplace safety in the RMG industry and this put the sector to be on high alert subject to continuous scrutiny (Mausumi, 2017).

Harmonious relationships are required for actors of IRs in order to protect the rights of all production parties (Salamon, 2000). In order to preserve a productive relationship among actors, each organization's key functions have been to prevent any conflict with them or resolve it as early as possible to guarantee industry stability and improve profitability (Hyman, 1975). It is more or less clear about who are the actors of IRs in the RMG industry of Bangladesh. It is imperative to identify their specific roles and measure their roles' associations with the current state of IRs in RMG industry in Bangladesh, which are not well understood and documented. The existing literature also lack a well-accepted theoretical framework based on which a study in IRs in RMG industry of Bangladesh be conducted. Considering the discussions made above, the present study has its significance for a good number of reasons, which are enumerated below:

Firstly, employees' movements have traditionally influenced the establishment of a safe workplace (Ishaque, 2019) despite the enterprises' usual objection to ensuring higher safety conditions (Jacoby, 2018). This study will help the employees develop an awareness of the benefits of maintaining a harmonious relationship among all the parties involved besides creating consciousness among them through making the issues involved public while dealing with their working conditions and other related affairs, and thereby setting up a good relationships among the members of TUs, employers, IBs and GAs.

Secondly, this study will provide guidelines to TU leaders, which will help them, realize their weaknesses while negotiating on the employee's interest with the management people and thereby helping the leaders involved in the negotiations overcome their weaknesses.

Thirdly, employers are concerned with maintaining a stable and reliable workplace and with establishing common employees' dispute laws to institutionalize class conflict. This study will show the relationships between TUs, employers, GAs and IBs and, the roles of the employers in RMG industries in Bangladesh for developing and maintaining satisfactory IRs situation.

Fourthly, the GAs have set up committees to discuss wages enhancement and other working conditions at the workplace, and developments in recent years have demonstrated that the GAs have taken over role of salary and wage determination for the RMG sector in Bangladesh. Therefore, this study will show the relationship of GAs with the state of IRs.

Finally, in this industry, now IBs is one of the important actors of IRs. The current study is therefore expected to explore the contribution of IBs in relation to other IRs actors. The study will also help the policy makers of the government to review the existing laws, rules, and policies for efficient performance of TUs, employers and IBs in RMG industries in Bangladesh. This research work will facilitate further studies by other researchers who have an interest in understanding the reciprocal relationships among TUs, employers, IBs, GAs and IRs of RMG industries in Bangladesh. Lastly, this study will add more knowledge to the existing literatures on IRs.

1.7 Key Concepts and Terminologies used

Confusion regarding definitions of key concepts and terminologies used for the research purpose can be an important concern of any research (Hossain, 2019). Thus, it is important to give clarification and definitions of several key concepts and terminologies used while conducting the research.

Industrial Relations: The relationships among employers, employees and their representatives, GAs and the IBs are called IRs (Al Faruque, 2009; Duara & Mallick, 2019; Hyman, 2013). In general, IRs include fields such as the relationships among employers, TUs, GAs involved in collective bargaining for working environment, workplace dispute resolution, freedom for association, contribution of IBs for their workplace compliances, labor laws practices etc. (Al Faruque, 2009).

Trade Unions: Trade unions are voluntary associations of employees organized to support, defend their rights through collective bargaining, and are an important part of the employer-employee interaction (Budeli, 2009; Dasgupta, 2002). The BLA 2006 defines, 'TU means TU of employees or employers organized and registered in compliance with chapter XIII of this act which shall include a trade union federation'.

Employer: An employer is an individual or a group those who have rights to hire employees and compensate them for their services (Bishop, 1957; McCleary et al., 2017). An employer may enforce labor laws, take any legal actions and legally responsible for working conditions as legal party (Noe, Hollenbeck, Gerhart & Wright, 2015).

Government Agents: GAs refers to a body of people who rule a society or a region (Wirtz & Birkmeyer, 2015). It creates and authorizes policies that promote and exercises legislative, political and constitutional powers through state customs, institutions and laws.

International Buyers: IBs who are purchasing products and services (Han et al., 1993). In the RMG industry, IBs enforce not only order-based requirements but also overall operational environment specific to manufacturers such as working hours, protection of workers, occupational atmosphere, contamination of the environment, manufacturing cycle, procurement of raw materials, quality management and regulation, social responsibility etc (Hossain & Arefin, 2015).

RMG: The full meaning of RMG is ready-made garment, that is, cutting and making of cloths ready-to-sell (Nuruzzaman, 2015). The production of RMG in Bangladesh is generally classified into two broad categories: woven and knit goods (Ahmed & Nathan, 2016).

Strategic Choice Theory: Strategic choice theory is concerned with explaining where the decisions are made in a system and the roles of the actors involved in the system while making strategic choices. Strategic choices are the outcomes of organizing union, strategic HRM, policies and laws, corporate campaign with workers' rights (Kochan, McKersie & Cappelli, 1984, p. 23). The strategic choice theory is the notion that tends to explain how leaders or leading groups play in influencing an organization through making choices in a dynamic environment. The theory is concerned with providing a set of strategic alternatives, out of which some are emphasized and picked up by the individuals and groups within organizations with a view to serving their own ends that dynamically influence the development of organizations (Kochan et al., 1984).

1.8 Thesis Layout

This thesis has six chapters. The overall structure of the thesis has been planned in the following manner:

Chapter One: Introduction

This chapter represents the background, problem statement, research questions, and objectives of this study. It also contains the significance of the study, definition of key terms, and layout the organization of the thesis.

Chapter Two: Literature Review

This chapter deals with an overview of the RMG sector in Bangladesh and its current picture. It also discusses the present industrial situation in the RMG industry of Bangladesh. This chapter presents an extensive literature review focusing on the RMG industry's IRs and its actors. It reviews the literature on the IRs and relevant studies related to the four actors of IR i.e. TUs, employers, GAs and IBs of the RMG industry of Bangladesh measuring the IRs situations. Finally, this chapter identified the sub-variables for the study along with the research gaps of the study.

Chapter Three: Theoretical Perspective and Hypotheses Development

This chapter presents the theoretical framework along with the justifications for the utilization of the proposed strategic choice theory. It also provides the conceptual research model followed by the hypotheses of study.

Chapter Four: Research Methodology

This chapter describes the methodology of the study covering the statement of the problems, justification for the selection of the research methods ranging from sampling to data collection methods to analytical methods and tools used for study. This chapter also delineates the research paradigm concerned, mixed-method used to accommodate the use of both qualitative, and quantitative analyses followed by pretesting of the instruments based on the opinion of a panel of experts and subsequently finalized based on pilot

testing. This chapter outlines the procedure for the interviews carried out as part of the fieldwork and the qualitative data collection by means of content analysis. Quantitative data are analyzed by using PLS based SEM.

Chapter Five: Survey and Quantitative Data Analysis

This chapter represents the results of the analyzed quantitative data collected from the field study. The results are shown by using the descriptive statistics, convergent and discriminant validity for the data used for analysis, measurement of the model; analysis of predictive relevance, and a summary of the hypothesis testing.

Chapter Six: Discussion, Conclusion and Future Research Agenda

This chapter addresses the results of the study, focusing on theoretical and practical perspectives along with its theoretical and practical contributions. This chapter explains the deficiencies of the research highlighting the future research agenda, and focuses on recommendations of having sound IRs in RMG industry of Bangladesh.

CHAPTER TWO

LITERATURE REVIEW

2.1 Introduction

The first part of this chapter presents an overview of the RMG sector in Bangladesh and its current picture. It also discusses the present problems and prospects of the sector. The second part includes an extensive literature review focusing on IRs and its actors, TUs, employers, GAs and IBs in the RMG industry of Bangladesh along with their roles and effects on IRs. The third part deals with the sub-variables, which are the basis for measuring the relationships between the actors and the IRs situation in the sector under study. Finally, the last part presents the research gaps the current study has been tailored to address.

2.2 RMG Industry in Bangladesh

According to Gaffar et al. (2019) the RMG industry is one of the main export earning industries in Bangladesh playing a special role within the economy of Bangladesh (Islam & Haque, 2018). At present, the total listed numbers of RMG enterprises are 4621 (BGMEA, 2019). Nonetheless, the sector has opened opportunities for employment to many individuals in direct and indirect economic activities that ultimately support social growth, empowerment of women and alleviation of poverty in the world. Particularly more than 4.4 million employees are directly employed in this sector (Rahman & Chowdhury, 2020) and the trend of the employment is upward, increasing at faster rates (Heath & Mobarak, 2015).

The RMG generates formal job opportunities for the people of Bangladesh who are mostly from urban areas (Saha & Islam, 2017). This gave employees the opportunity to be financially secured and have a voice in the family decision, as they are now making financial contributions. Most employees came from low-income families and so they were greatly supported by a small sum of funding. The industry is to compete in the world market by lowering the overall production costs through utilizing cheapest employees and utilities (Anner, 2020).

Bangladesh has set an ambitious goal for reaching a target of 50 billion US dollar exports of apparels by 2021 and it seems to be on the right path (Rahman & Chowdhury, 2020). To achieve this target more than 4.7 thousand garments factories are to be established in Bangladesh by that time (Hasan et al., 2018). Bangladesh plans to achieve its middle-income status by 2021 wherein the RMG sector will play a significant role (Khatun & Afroze, 2019). In addition, Bangladesh has a large number of jobless employees who are uneducated and unqualified but valuable to the RMG industry (Islam & Asaduzzaman, 2015). However, the RMG sector in Bangladesh has yet some problems such as lack of proper working environment and its ignorance to labor rights, which the IBs are continually harping to uphold (Nuruzzaman, 2013). Such kinds of acts and events potentially have a negative effect on the Bangladesh RMG industry (Ansary & Barua, 2015).

2.2.1 Historical Changing Pattern of RMG Industry in Bangladesh

The roles of the RMG industry are considered to be very influential in the area of industrialization in both developed and developing countries (Rasel, Das & Khan, 2019). Britain's historical evidence shows that Lancashire's RMG in England launched the world's first industrial revolution in the 18th century (Chapman, 1987). In fact, in the past 200 years around the world so many countries have been using the fashion and RMG industry as a growth factor and a base for achieving global progress (Rhee, 1990). The RMG industry has played significant roles in industrialization. Such industrialization generated economic growth process over the past decade (Hossain, Kabir & Latifee, 2019).

The development and progress of the RMG industry in Bangladesh has been relatively recent. No RMG industry was present in the portion of the Indo-Pak-Sub-Continent during the British period (Uddin & Jahed, 2007). The first RMG factory was established in Dhaka, Bangladesh, in 1960 (the then East Pakistan) and until 1971 the number of RMG units was growing to give having really no significant impact on the then economy. Yet such RMGs were intended to outfit to the demand of the home market. Some businesspersons set up 100% export-oriented garments industry between 1976 and 1977 (Islam, 1984).

In Bangladesh, RMG industry has grown up rapidly that benefited both the domestic and foreign arena (Kurpad, 2014). By the mid-seventies, the existing RMG manufacturers in the world markets were expanding i.e. Hong Kong, South Korea, Singapore, Taiwan, Thailand, Malaysia, Indonesia, Srilanka and India have been heavily limited by the quota limits levied by their main buyers, such as the United States of America (USA), Canada and the European Union (Hasan et al., 2015). They adopted the policy of relocating garment factories in some countries that were free of quota restrictions and had reasonably trainable cheap labor at least at the same time in order to preserve their business and competitive position on the global markets (Uddin, 2014). They found Bangladesh to be among the most appropriate countries. Worthwhile records reveal that in 1977, Reaz and Jewel Garment delivered the country's first consignment of clothes (Chowdhury, Ahmed & Yasmin, 2014).

Desh Garment became Chittagong's first major factory to begin its operations in 1977 (Ahamed, 2013). That was really the optimistic beginning of a kind of joint venture garment plant in Bangladesh. Afterwards, several businesspersons became involved and began setting up textile factories following foot printing of the Desh textile discerning the potentials of its future globally (Feldman, 2009). The partnership of a local private garment company, Desh garment with a Korean company, Daewoo, is one of the reasons for the growth of RMG industry in Bangladesh (Nuruzzaman, 2013).

As a part of global strategy, South Korea's Daewoo Company became involved in Bangladesh when Chairman Kim Woo-Choong suggested the Government of Bangladesh that entrepreneurs initiated joint venture companies be established to launch the production and the operation of factories for rubber, leather goods, cement, and garments (Rock, 2001). The reason behind this desire was that for importing raw materials, Bangladesh would rely on Daewoo and thereby Daewoo would capture the market in Bangladesh (Ahamed, 2013). Daewoo has signed a five-year collaboration agreement with Desh Garment and under this arrangement Daewoo helped the Desh Garments Limited through providing technical training, machinery, clothes and setting up of plants and product promotion in exchange for commission, since Daewoo had the opportunity to export all those from its home country to Bangladesh, it had made it possible to fulfill its

desire for foreign earnings through exporting them to Bangladesh (Alam, Selvanathan & Selvanathan, 2017; Rock, 2001). Desh's export value rose at an average annual rate of 90% to over USD 5 million in the first six years of their partnership (Mahmood, 2010). Yunus and Yamagata (2012) concluded that the Desh-Daewoo partnership is a significant factor in the growth and stability of Bangladesh's entire export oriented textile industry.

The Agreement on Textiles and clothing (ATC) of the World Trade Organization (WTO) was in effect from 1995 to 2005, whereby more advanced countries agreed to export fewer textiles, while less developing countries received higher quotas for exporting their textiles (Yang & Mlachila, 2007). Under the 10-year deal, Bangladesh's economy gained from quota-free entry into the European markets and attractive quotas for the USA and Canadian markets (Abernathy, Volpe & Weil, 2004). The RMG industry in Bangladesh was largely dependent on imported fabrics until FY 1994, while the Primary Textile Sector (PTS) did not produce the necessary fabrics and yarns (Mostafa, 2006). The knit section has expanded since the early 1990s usually to produce and export shirts, t-shirts, trousers, sweaters, and jackets (Alam et al., 2017).

The gradual abolition of the quota system began in 1995 and was totally eliminated in 2005. Because the elimination of the quota opened the opportunity to the global buyers to import as many garments as they could from their desired suppliers, the gradual abolition of the quota has given rise to a fierce competitive pressure in the sector under study. The global spreading of production systems to the host countries, which were the least developed, and developing one favored the growth of developing countries and helped to develop those countries' pace of progress. The global economy began to be dominated by the relocation of production systems, under which arrangement the firms from developed countries shifted their production processes to developing countries in order achieving competitive advantage over their rivals. The RMG industry in Bangladesh was not free from the effect of such relocation of production systems.

The year of 2005 has been the crucial for the RMG sector in Bangladesh because of the fact that since the year of 1974 the Bangladesh RMG sector was driven by the quota facilities under the MFA, which was fully abolished on 31 December 2004 with the end of

Uruguay round, leaving Bangladesh in an uncertain situation to face head to head competition with the matures rivals. Until this time, Bangladesh did not need to face any competition. On first January 1995 the MFA was replaced by the ATC, which was applied to all 147 member countries since then. The MFA was phased out in four stages over 10 years (1995–2005) according to the conditions enshrined in the ATC.

The Bangladeshi RMG firms started to face competition with the end of the MFA facilities. After the abolition of the MFA, Bangladesh was expected to face dire situation in its garments industry and was supposed to incur losses. The MFA was introduced in 1974 to serve as a short-term protection measure for the textile and clothing industries in developing countries like Bangladesh. The MFA did not apply to trade between rich industrialized countries. After the introduction of the MFA, Bangladesh took its full opportunity and became one of the vibrant exporters of garments. After the MFA was phased out, Bangladesh entered a new quota-free business environment but highly competitive one. Cambodia, Nepal, Haiti, Laos, Lesotho, Madagascar, Myanmar, Vietnam and many Sub-Saharan African and other Asian countries emerged as major exporters of manufactured garments (Fiaz 2006).

Starting with a meager amount of earning amounting to only USD 31.57 million made in 1983, the Bangladeshi garment sector made earnings in foreign exchange exceeding not less than an amount of USD 15 billion by the year of 2010 and had become one of the top ranking global exporters. In the FY 2008-09, Bangladesh became the fourth largest manufactured garments exporting country in the world. While enjoying the status of third largest garment exporter to the EU and fourth largest exporter to the USA (Berg et al., 2011). The industry was worth USD 34.13 billion in 2019 (Anner, 2020). Bangladesh has already occupied the position of second largest apparel exporting country in the world (Anner, 2020). The role of young entrepreneurs, availability of cheapest labor and utility facilities along with government support through its various agencies like Export Promotion Bureau (EPB), Board of Investment etc helped this sector to achieve its rapid growth. In 1981, while there were only 21 RMG units in the country by 2019 the number rose to 4621 units (BGMEA, 2019).

On April 24th 2013, 1132 people were died when the eight-story building named Rana Plaza collapsed and around 2500 were injured, marking it as the ‘worst industrial disaster in recorded history’ (Sobhan, 2014). The scale of Rana Plaza tragedy induced a range of scrupulous and concerned stakeholders into taking coordinated action to address the health and safety issues in Bangladesh’s export garment industry. The instantaneous responses made following the tragedy included two measures-Accord for Fire and Building Safety and the Alliance for Bangladesh Workers’ Safety. These two arrangements compelled the lead retailers and brands to enter into alliances with a range of other necessary actors to tackle the problem in the factories that are supplying garments. These initiatives have been marked by many as ‘historic’ and ‘game-changing’ (Kabir, Maple & Fatema, 2018): they represented a shift beyond the buyer-driven compliance-based model into a kind of ‘cooperation-based’ model with multiple stakeholders. Where, the buyer-driven compliance based model seems to be dominated by the concept of corporate social responsibility (CSR) (Nuruzzaman, 2013).

After the Savar tragedy, the scenario has been changed (Hossain & Oh, 2019). In July 2013, Bangladesh government amended the Labor Act 2006, making it more suitable for protecting employee rights, including the right to freedom of association and collective bargaining (Ahmed, Greenleaf & Sacks, 2014). For a public body to take over, the establishment of an Remediation Coordination Cell (RCC) was made necessary; making it imperative that it will provide the remediation services for enhancing and retaining the quality and standards (Tarannum & Ansary, 2018). During the periods of 2014 to 2019, in RMG industry it is witnessed series of ups and downs.

However, it is provided sufficient evidence that the RMG sector of Bangladesh is waking up to the dawn of a new era, with an increasing recognition that what has worked in the past will not necessarily work in the future (Masum, 2016). The industry will enter the next decade in a position of relative strength and is well poised to take advantage of the prospects that will surely emerge as China’s share of the global apparel market shrinks (Ahlquist & Mosley, 2020). Though from the very beginning of the year 2020, due to the

pandemic situation unleashed by COVID 19 the unstable nature of the global economy undoubtedly impacted global trading patterns. Similarly, our primary export sector has faced a major challenge, but the sector could handle the situation effectively and efficiently. Accordingly, the IBs are preceding their orders and this sectors doing well during this difficult time of the world (Mohiuddin, 2020).

The government of Bangladesh expects that the total exports of the country would pull in more than USD 50 billion by 2021 (Khatu & Afroze, 2019). In this respects, the exports of the RMG industry is projected to rise by 12-15% a year to meet the export goal of USD 50 billion by 2021 (Kays, Prodhan, Karia, Karim & Sharif, 2019). To meet USD 50 billion in exports, the average factory would export USD 50 million each and it should expect 1000 factories as opposed to an average of only USD 6 million for 5000 factories (Rashid & Taibb, 2020). For the effective growth of the RMG sector over the next five years, there is a need for more active collaboration among the actors engaged in this RMG sector in order to establish and promote industrial peace (Wilkinson, 2020).

2.2.2 Present Scenario of RMG Industry in Bangladesh

Bangladesh plans to achieve the middle-income status by 2021 in where the RMG sector will play a significant role (Khatun & Afroze, 2019). Bangladesh has set itself the target of achieving 50 billion USD in apparel exports by 2021 and it seems to be on the right path (Kays et al., 2019). For achieving this target more than 4.6 thousands of garments factories are engaged in Bangladesh, the number of garment factories are also steadily growing with steady to high growth rates (BGMEA, 2019). The following figure 2.1 shows the growth of RMG factories of Bangladesh.

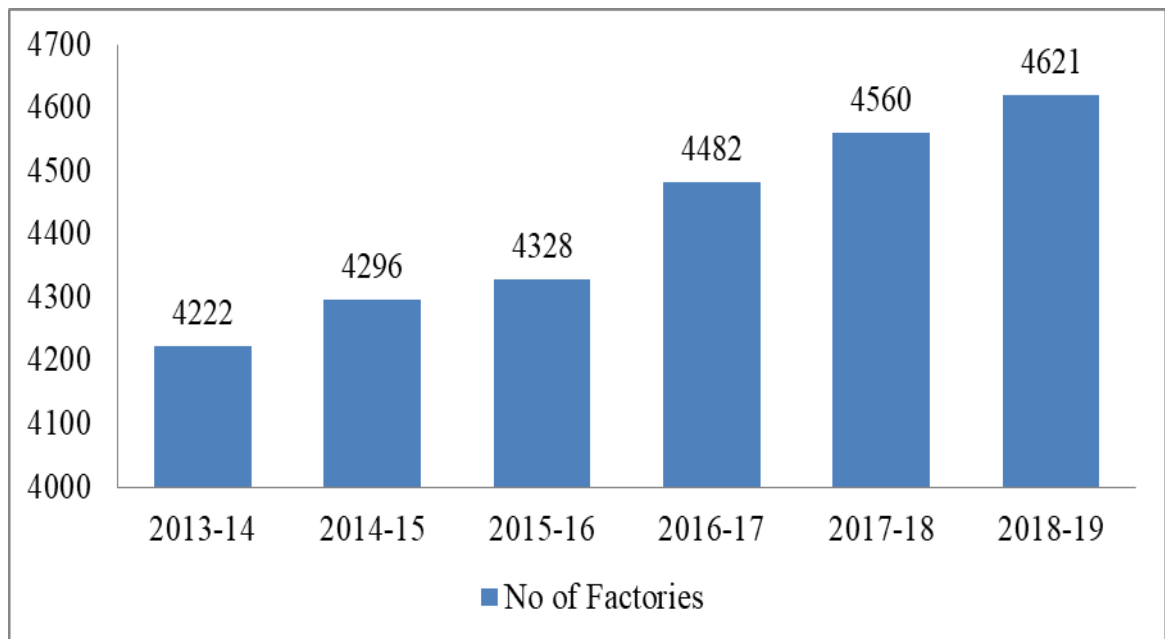

Figure 2.1: Number of RMG Factories in Bangladesh

Source: BGMEA, 2019

The number of factories in Bangladesh in FY 2016-17 was 4482 and rose in FY 2018-19 by 3.10% to 4621. Compound Annual Growth Rate (CAGR) is expected to improve of 1.53% to 4764 in FY 2020-21 from FY 2018-19 (EPB, 2019).

RMG prices of Bangladesh are still following a downward trend with higher cotton prices because the IBs are unwilling to pay local manufacturers and exporters a fair price (BGMEA, 2019). Throughout Bangladesh, the price of cotton plays the very significant role in the industry as cotton fabric production is still high relative to man-made fiber or viscose fiber fabric production (Habib, 2016). Around 90% of overall garments exports of Bangladesh are cotton based (Karaalp & Yilmaz, 2013). According to the BGMEA (2019), Euro and USD prices dropped by 3.64% and 7% respectively as a result of intense demand pressure from marketers and distributors due to erratic global consumption. Figure 2.2 shows the RMG prices movement in Bangladesh.

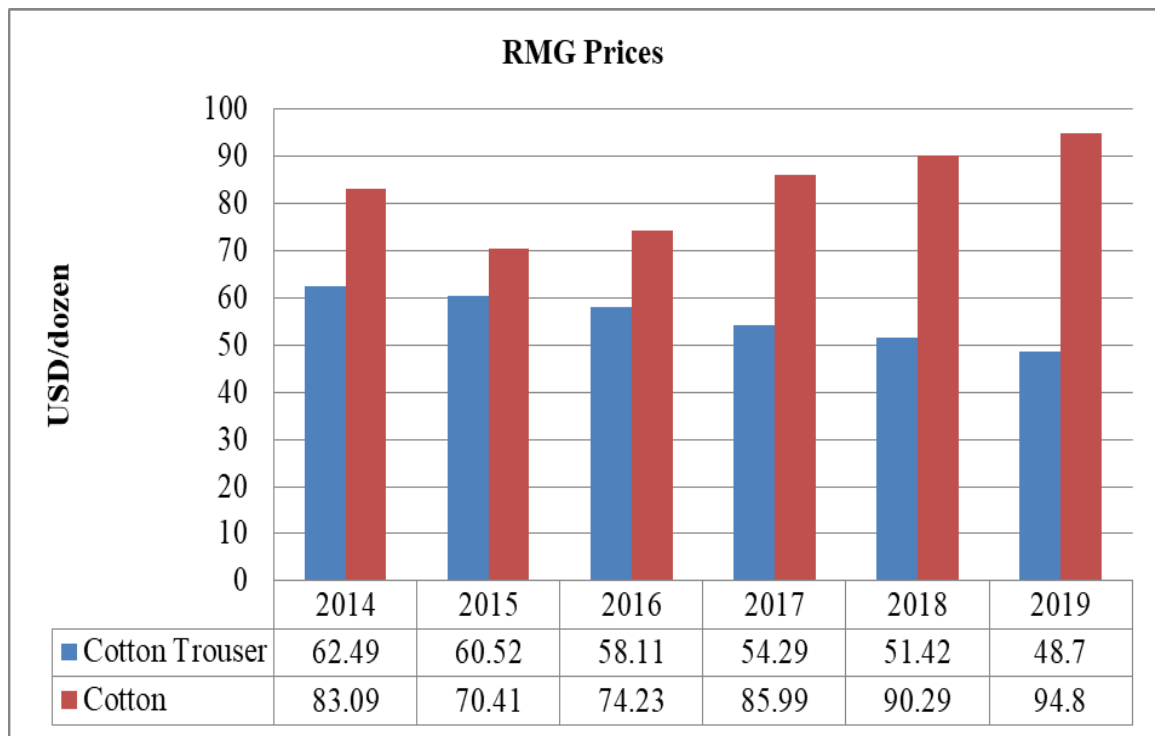

Figure 2.2: RMG Price Movements in Bangladesh

Source: WDSRN, 2019

According to a report by the Worker Driven Social Responsibility Network (WDSRN), 2019, a dozen cotton trousers made in Bangladesh sold for USD 62.49 in 2014 and fell by 22.17% to USD 48.70 a dozen in 2019. Cotton prices in 2014 were USD 83.09 per dozen; falling to USD 70.41 in 2015 and again upwards from the year of 2016. In 2019 the cotton prices has become USD 94.80 per dozen.

According to Ishaque (2019) and EPB (2019) the gross export of RMG from Bangladesh in FY 2016-17 was USD 28,149.84 million and rose by USD 26.90 to USD 35,724.33 million in FY 2018-19. Total exports in FY 2018-19 grew by 16.69% over the previous year and are forecast to hit USD 38,984.92 million in FY 2020-21 with a CAGR of 12.65% from FY 2018-19. The figure 2.3 below presents RMG Export Market of Bangladesh.

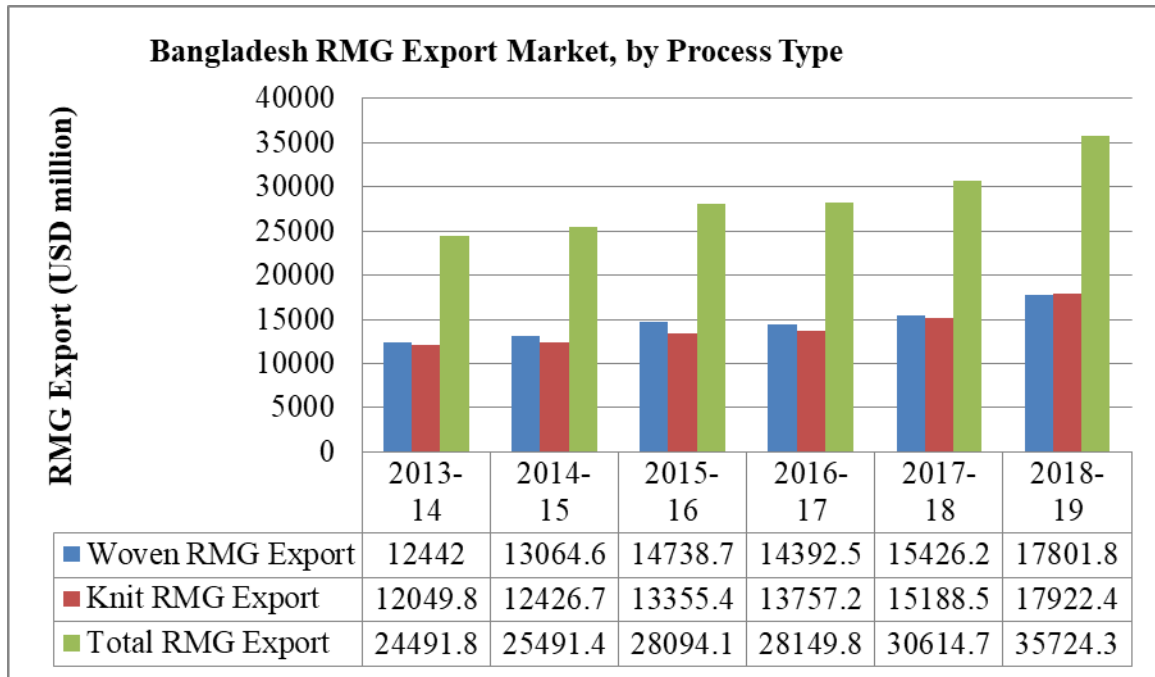

Figure 2.3: Bangladesh RMG Export Market by Process Type

Source: Ishaque (2019) and EPB (2019)

The above figure 2.3 shows that the total number of woven exports of RMG in FY 2016-17 was USD 14,392.59 million and increased by 23.69% to USD 17,801.89 million in FY 2018-19. Total exports in FY 2018-19 increased by 15.40% over the previous year and are expected to reach USD 19,105.35 million in FY 2020-21 with a CAGR of 11.22% from FY 2018-19. The gross export knit RMG in FY 2016-17 amounted to USD 13,757.25 million and rose by 30.28% to USD 17,922.44 million in FY 2018-19. Total exports in FY 2018-19 grew by 18% over the previous year and are forecast to hit USD 19,879.57 million in FY 2020-21 with a 14.14% from FY 2018-19 as per CAGR.

Shirts, trousers, jackets, t-shirts and sweaters have made a huge contribution to the exports of RMG from Bangladesh. For much of the overall exports trousers and t-shirts added (Adnan et al., 2015). In overall Bangladesh RMG exports for FY 2018-19, trousers and t-shirts contributed 27.85% and 28.14% respectively. The figure 2.4 presents the RMG export of Bangladesh by garments type.

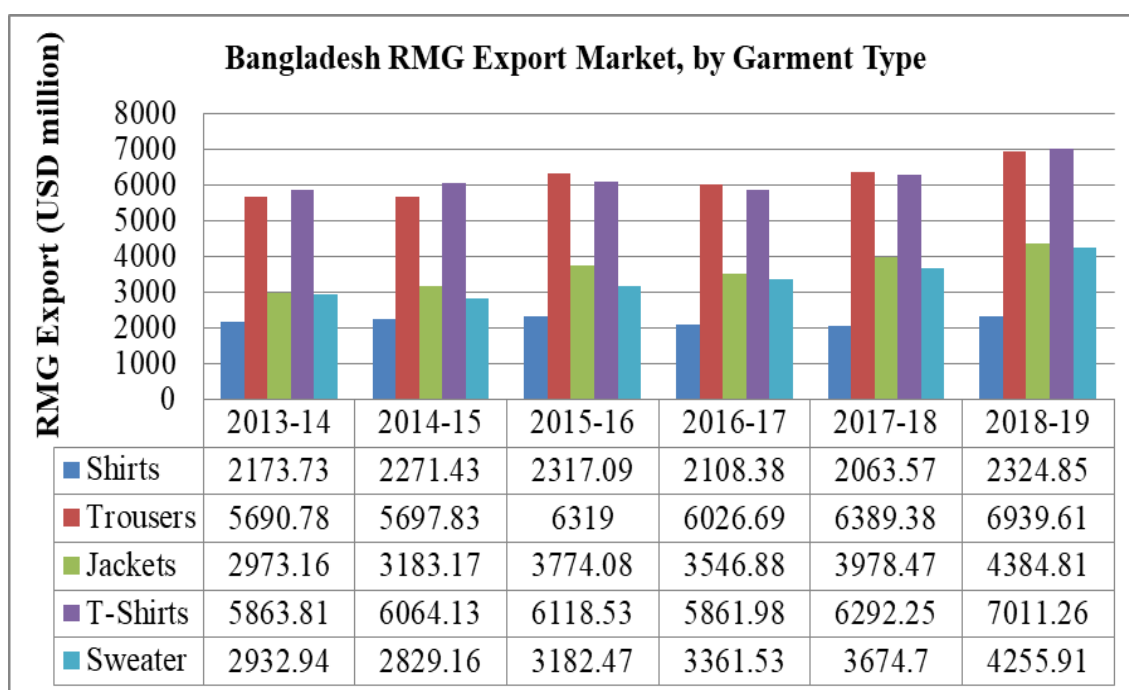

Figure 2.4: Bangladesh RMG Export Market by Garment Type

Source: BGMEA & BKMEA, 2019, Ishaque, 2019

The above figure indicates that exports of sweaters and jackets have risen from FY 2016-17 to FY 2018-19, with a fast growth rate of 26.60% and 23.62% respectively, out of all the above segments. CAGR is expected to increase exports of shirts, pants, jackets, t-shirts and sweaters by 5%, 7.31%, 11.18%, 9.36% and 12.51% to USD 2,563.55 million, USD 7,990.82 million, USD 5,420.70 million, USD 8,385.86 million and USD 5,388.25 million respectively in FY 2020-21 from FY 2018-19 (BGMEA & BKMEA 2019; Ishaque, 2019).

Bangladesh has benefited immensely from the dissolution of the Trans-Pacific Partnership (TPP) deal between the US Government and 11 countries: Australia, Japan, Canada, New Zealand, Mexico, Singapore, Malaysia, Vietnam, Chile, Brunei and Peru. This referred to a newly imposed tariff on Vietnamese clothes, one of the main competitors of Bangladesh (Rahman & Ara, 2015). The following table 2.5 shows the export of woven products from Bangladesh from FY 2016-17 to expected (E) FY 2019-20 and forecasting (F) of FY 2020-21.

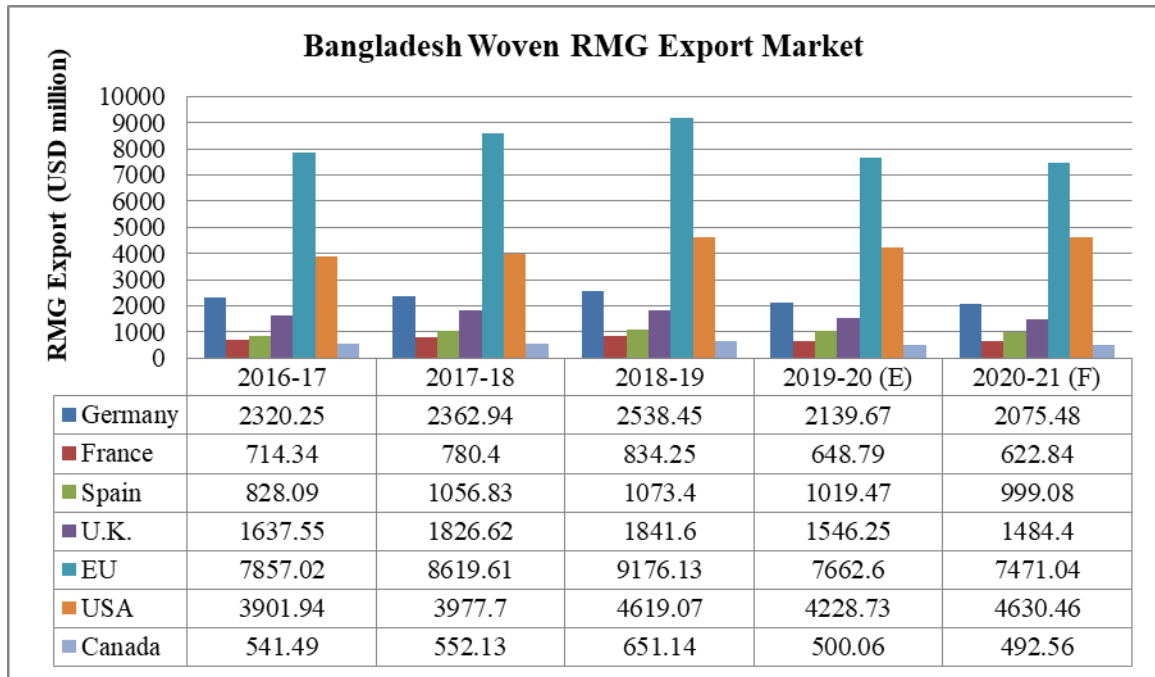

Figure 2.5: Bangladesh Woven Export Market

Source: BGMEA, 2019

The woven RMG export market of Bangladesh is shown in the above figure 2.5. The EU countries are the most important where a huge woven RMG are exported. In the year of 2018-19 the market was USD 9,176.13 million and it is expected that in the year of 2019-20 that will be USD 7662.6 million. USA is one of the big markets for Bangladesh. Other than these two, Germany, United Kingdom, and Spain are also large RMG markets of Bangladesh (Ishaque, 2019).

There are a number of external factors that have played a major role in supporting the growth of RMG sector. The trade war between the USA and China and the resulting decline in China's bulk production due to labor shortages and higher costs are some of the major reasons for this, contributing to a reduction in its prominence in the fashion industry (Ahmed & Hossain, 2009). In addition, China is now engaged in producing goods that need higher expertise, improved infrastructure, and more spending in advanced equipment. The Bangladesh government has decided to raise cash incentives for RMG exporters from 3% to 4% in developing markets in an attempt to enter new

export destinations (Anner, 2020). The move is aimed at enabling RMG producers to promote exports to new countries, starting from the FY 2018-19 (Mian, 2020). Non-traditional export markets are very important in raising export reliance on conventional markets for Bangladesh. This wants to seek more export destinations in order to increase amount of exports. Bangladesh's RMG has both non-traditional and emerging export markets, including China, Russia, Japan, India, Australia, South Africa, Turkey, Brazil, Chile, Mexico, Malaysia, South Korea, and New Zealand (Haque, 2018).

The RMG sector of Bangladesh has experienced remarkable growth in the country, but there are some reports that the employees are not happy with the pay trend (Ahmed & Nathan, 2016). The research by Islam and Chowdhuri (2012) aimed at defining the socio-economic status of RMG employees in Bangladesh related to improving the living standards of employees, education, hygiene practices, and a favorable position for employees. Khatun and Shamsuzzaman (2015) concentrated on the satisfaction of workers in the RMG industry in Bangladesh by evaluating the employment conditions of workers and their failure to comply with existing labor legislation.

There are also some claims regarding the working conditions of RMG sector in Bangladesh like poor social compliance, which include the inadequate application of labor standards by the RMG sector, and labor rights, legislation and implementation, effective facility for negotiation (Saha & Mazumder, 2015). Having growing demand for RMG of Bangladesh on the foreign market and increasing this segment, there is a need for development in some fields, such as labor prices, business environment, export management, improved compliance and employees' skills (Iqbal, 2015). Chowdhury and Ullah (2010) identified the conditions of employees from a social and economic context and suggested that progress in the prevailing socio-economic facilities is highly required in order to achieve employees' happiness, which will bring the ultimate success of the RMG sector in Bangladesh. The following table 2.1 shows some recent incidents in RMG industries of Bangladesh.

Table 2.1: Some Recent Incidents in RMG industries of Bangladesh

Factory Name	Location	Incident Date	I.	D.	Cause/Outcome Description
Tazreen Fashions Ltd.	Ashulia, Dhaka	24.11.2012	200	112	The short electric circuit that started from the ground floor triggers the fire. The building was a factory with nine floors.
Swan Garments Ltd	Uttara, Dhaka	26.11.2012	0	1	The fire occurred in the warehouse of Swan Garments Ltd at about 9.30 am on the day of the fire.
Section Seven Garments	EPZ Chottogram	28.11.2012	50	0	Due to a mechanical failure of the power generator, fire was produced when about 50 garment workers, most of them females, were injured.
Vision Apparels Ltd	Savar, Dhaka	29.11.2012	100	0	Because of the fire rumor spread, fear grasped and raced downstairs for this worker on the first floor, losing over 100 people in the stampede.
AKH Stretch Garment	Beribadh, Dhaka	05.12.2012	50	1	The workers were very afraid of sudden sparks from the tube light and 1 death and 50 injured were due to falling from the staircase.
Active Composite Ltd	Ashulia, Dhaka	06.12.2012	50	0	Due to the energy ignited from a generator as more than 50 employees were injured, employees were running for safety panic.
Abonti Colour Text, Unit 2, sister concern of Crony Group	Fatulla, Narayanganj	07.01.2013	50	0	At least 50 garment workers, mostly women, were wounded in a stampede caused by a Monday night fire panic.
Smart Export Garment Ltd	Mohammedpur, Veribadh	26.01.2013	15	7	The fire was caused due to the electrical short-circuit and for this seven workers were killed and other 15 were injured.
Envoy Garments Ltd.	Beron, Ashulia	02.02.2013	100	0	A false fire alarm stampede triggered and for why about at least 100 workers were injured.
Rana Plaza	Savar, Dhaka	24.04.2013	1132	2500	The eight-storied Rana Plaza was collapsed due to the building cracks. The building collapsed during the morning rush-hour. The death and injury of the event was record ever.

Factory Name	Location	Incident Date	I.	D.	Cause/Outcome Description
Tung Hai Sweater Limited	Mirpur	08.05.2013	0	7	Because of the fire that swept through a sweater factory, seven people were killed, including its owner and an additional deputy inspector general of police.
Aswad Composite Mills	Gazipur	08.10.2013	50	10	On that date the fire originated in the dyeing section of the factory and caused 10 deaths and 50 injured.
Karnaphuli Knitting, Siddique Knitting Fashion Park International Ltd	Shitaljharna, Chittagong	11.05.2014	0	2	The fire occurred by means of an electronic short circuit.
Mayer Doha	Kamrangirchar, Dhaka	10.07.2014	3	1	When the fire broke out, the workers were sleeping.
Mega Yarn Dyeing Mills Limited	Gazipur	28.09.2014	4	1	On the 3rd floor of the nine-story building, one worker died and four others were injured due to the blast.
Momo Tex	Panchdona, Narsingdi	22.05.2016	15	3	Fifteen workers burnt and three died due to an electric short-circuit at the storehouse.
Multifabs Limited	Konabari, Gazipur	03.07.2017	20	13	This incident was placed due to the boiler explosion in the factory and for this 13 died and other seriously injured.
Ideal Textile Mill	Munshiganj	20.09.2017	0	6	Fire broke out and 6 workers died at Ideal Textile Mill in Munshiganj.
Plummy Fashions Ltd	Fatullah, Narayangonj	03.11.2017	0	1	A fire in the control panel broke out due to a short circuit of a soft setting calendar machine of the factory.
Guardian IPS Factory	Andarkila, Chottogram	28.01.2018	7	1	Fire broke out from the factory and caused 1 death and 7 injured.
Sadid Sourcing	Kazipara, Mirpur	03.31.2018	2	1	The fire originated from the factory ground of the six-storey building and caused 1 death and 2 injured.

Source: Solidarity Centre, 2019, *I=No of injured, D= No of Deaths

2.2.3 Problematic Aspects of RMG Industry in Bangladesh

Earlier stated that on 24 April 2013, at least 1,132 people were killed and more than 2,500 injured by the collapse of the Rana Plaza building in Dhaka, Bangladesh, which housed five garment factories. Just five months earlier of this tragedy, at least 112 employees, trapped inside the burning Tazreen Fashions factory on the outskirts of Dhaka, lost their lives in another horrific accident (Sinkovics, Hoque & Sinkovics, 2016). According to Bangladesh Institute of Labor Studies (BILS) in 2016, a total 237 industrial disputes and worker actions took place in 2015, from which about 122 workers actions were recorded in the RMG industry. Another report by Center for Policy Dialog (CPD) in 2016, about 115 labor unrest cases occurred in the RMG.

The labor unrest occurred on December 2016, due to wage hike. The leaders have demanded that all cases filed against apparel workers be withdrawn. The leaders also figured a worker's minimum wage should be increased to Tk. 16,000 instead of current salary 5300 (2017 in Bangladesh). Bangladesh RMG factories sacked 1,500 staff on 23 December 2016 due to demonstrations forced a week-long closure at dozens of sites supplying top European and American brands (Mamun & Griffiths, 2020).

About 181 incidents of labor unrest took place in the country's industrial sectors in 2017 while the highest number of unrest was happened regarding the arrear wages issues of the workers in 2017 (BILS, 2018). The report by BILS (2018) showed that 59% of the total unrest took place in the RMG sector. According to the report, arrear wages caused 56 unrests in the industrial sectors while 35 took place over several rights of workers. The report showed that other unrests took place regarding overtime, compensation, illegal closure of factory and workers termination. Out of total 181, highest 91 unrest incidents took place in RMG sector. Workers staged 68 demonstrations, formed 21 human chains, and observed 18 strikes, 15 road blockades, and 12 rallies to realize their demands in the industrial sectors. The BILS survey also found that some 784 workers including 21 females died in workplace accidents in RMG sector (Choudhury & Rahman, 2017).

In the period of 2018, in mid-December and again in mid-January, over 50,000 RMG workers in Dhaka, Ashulia, Narayanganj, Savar, and Gazipur districts took part in wildcat strikes, protesting pay reforms (Kays et al., 2019). In September 2018, the government of Bangladesh from previous Tk 5,300 (USD 63) to increase the monthly minimum wage for garment workers-for the first time in five years to Tk 8,300 (Munshi, 2018). Many RMG employees are unhappy with the rise as employees' rights organizations and TUs have been pressing for Tk 16,000 at least (Hasan, Parven, Khan, Mahmud & Yajuan, 2018). Others were dissatisfied with the rising disparity between junior and senior employees. While employees complain the rise is not adequate to meet the increasing cost of living, factory owners argue they cannot afford to pay higher salaries (Moazzem, 2019). In December 2018, TU leaders said government authorities had threatened them with detention or expulsion in public and private settings if the demonstrations proceeded ahead of the December 30 general election (Hamja, Maalouf & Hasle, 2019). As demonstrations were held again in January 2019, witnesses told by Human Rights Watch (HRW) that Bangladesh police used water guns, tear gas, and rubber bullets against them. One worker was killed and more than 50 were wounded (Elahi, Hosen & Nizam, 2019).

About 423 incidents of labor unrests took place in the industrial sector in 2019 while at least 131 unrests occurred in RMG sector this year, according to a report of BILS (2019). Most of the unrests took place over unpaid wages and allowances, labor rights, lay-offs and low wages, according to the report, which was prepared on the basis of media reports from January 1 to December 30 of 2019. Following strikes in mid-January 2019, TU leaders reported that at least 7,500 RMG employees have been dismissed from their jobs. Any of those who were fired, were charged with inflammable and theft, but the accusations remained broad and unclear. At least 29 criminal charges have been filed against 551 persons, as well as more than 3,000 unnamed people, leaving employees at risk of being potentially unfairly prosecuted with one of those cases. More than 50 employees were arrested, with 11 denying bail (Elahi, Hosen & Nizam, 2019).

For this reason, the export contribution of the RMG sector to GDP dropped by 3% in the FY 2017-18 (BGMEA, 2019). In addition, in the FY 2018-19, the contribution is 14% which is lower compared to the previous six years. In addition, until June 2019, Bangladesh was

marginally ahead of Vietnam in the overall export of apparel and textiles. Bangladesh's apparel gained USD 1.17 billion more than that of Vietnam between January and December 2019, helping Bangladesh to hold its second position (Sen, Antara, Sen & Chowdhury, 2020). Vietnamese apparel gained USD 30.94 billion over the period between July 2019 and June 2020, whereas Bangladesh raked in 3rd position with USD28.82 billion (Faiz & Maitra, 2020).

2.2.4 Prospects of RMG Industry in Bangladesh

After the Savar tragedy, the scenario has been changed (Hossain & Oh, 2019). In July 2013, the Bangladesh government changed the Labor Act 2006, making it more suitable for protecting employee rights, including the right to freedom of association and collective bargaining, (Ahmed, Greenleaf & Sacks, 2014). In 2017, a new structure was established under the Ministry of Labor and Employment (MoLE), namely RCC, in order to track the progress of remediation-related activities of factories under the National Initiatives and other factories under the Agreement and Partnership (Donaghey & Reinecke, 2018). For a public body to take over the establishment of an RCC is necessary; at the same time, it is essential that this set-up will provide the services retaining the quality and standards (Tarannum & Ansary, 2018).

The legal conditions for establishing TUs seem to be more flexible. Recent times have seen a noteworthy enhance in the number of TUs at the RMG factories. The total registered number of active TUs in RMG industry is 909 (DoL, 2020). In fact, the government provides more attention to the TUs and their activities (Siddiqui, Mehjabeen & Rahman, 2019). Recently a helpline, i.e. 16357, has been launched by the Inspection Department for Factories and Establishments (DIFE) and any worker can register their complaint through this number with toll free (Vaughn, Balch, Johns & Currie, 2019).

International buyers are seen as an essential business factor (Nurruzaman, Haque & Azad, 2016). The IBs have overlooked RMG factories workplace environmental problems, as Bangladesh is a developing country with its large population (Barua, Kar & Mahbub, 2018). Yet international buyers' compliance criteria have improved along with the price and quality of the goods (Hossain

& Arefin, 2015). IBs are now forced to evaluate some of the factors that the RMG manufacturers need to take into account in order to ensure a proper working environment and the welfare of the workers with conditions related to their order (Rahim, 2017) along with no forced labor, child labor, inequality in jobs, salaries, collective bargaining and TUs activity etc (Hossain & Arefin, 2015).

Accord and Alliance, and subsequently initiation of RCC work under the MoLE's, DIFE, has begun the integration process. In the transition phase, this specialized cell was working and meeting the requirement (BGMEA, 2019). The Cell's initial goal is to control, evaluate, and revisit the success of factory remediation activities previously reviewed under the National Initiatives (Government Initiatives initiated by DIFE). Under ACCORD and ALLIANCE-led steps, the RCC will steadily take up factory duties and finally take up inspection related activities of all manufacturing firms in Bangladesh (ILO, 2017).

In order to emerge as a middle-income country by 2021, Bangladesh must reach its 2021 manufacturing goal, which constitutes 90% of exports; it must significantly raise its production and capture a 28% share of GDP (Jahan, Rahman & Islam, 2018). This is only feasible if the output of RMG continues to achieve double-digit annual growth. Bangladesh must meet its manufacturing target of 2021, which comprises 90% of exports, in order to develop as a middle income nation by 2021, which has achieved double digit growth in bonafide government policies and funding since the beginning of 2018 (Mizan, 2018). It has made possible a lot of government trade strategies that are extremely beneficial to the RMG of Bangladesh. These policies include duty free material imports, bonded warehousing facilities, back-to-back Letter of Credit (LC), rapid custom clearance and many holistic measures worth noting (Hasan et al., 2018).

In 2021, the RMG sector has the potential to expand further (Sarkar, Qian & Peau, 2020). It will hit the heights with concrete assistance from our country, buyers, and all other related organizations. However, with hopes in the minds of millions of Bangladeshis, it might not be difficult to attain that feat (Anner, 2020). Good IRs is very important for ensuring a

productive RMG sector (Alam et al., 2018) and its sustained growth because the sound relationships among the four actors of IRs such as TUs, employers, GAs and IBs will establish and allow good IRs in the sector under study.

2.3 Industrial Relations

Industrialization is very important for economic growth and long-run poverty reduction of any country (Adewale, 2017). The present world and its globalization has brought the competitive dynamics of nations, firms, and industries (Pun, Chan, & Chan, 2010; Gereffi, 1999). The low skilled and labor-intensive industries migrates countries, which have labor markets. The RMG producing industry is the typical example in such industry world (Taplin & Winterton, 2004).

Industry is the manufacturing of production process managed and operated by human or a team of human (Gereffi, 1999). In the industry there are some actors involved (Hyman, 2008). Relations mean the relationship among the actors involving the manufacturing or production process (Akhter, 2014). Generally, IRs means the collective relationships of employer and employees (Hyman, 1975). The relations also include industrial life of all concerned parties such as working condition, discipline and CoC, terms of employment, compliance of labor laws and its interpretation, workers' presence in management issues, profitability sharing, industrial conflicts and grievances, unfair labor practices and, TUs and collective bargaining (Kochan, Katz & McKersie, 2018).

A conceptual aspect of IRs includes the organizational interactions and relationships among its actors i.e. employers, employees, buyers and the government (Tapia, Ibsen & Kochan, 2015). It is a multidisciplinary field of HRM with orientation towards organizations' harmony and wellbeing. According to the John Dunlop (1958), three actors are in IRs to maintain dynamic employment relationship, which includes employer and its association, employee and its association, and government and its agents.

The industrial situation what is usually termed as IRs describing the functional relationships that prevail due to numerous of interactions between employees and employers (Kelly, 2012).

The functional relationships are influenced by various factors such as social, psychological, economic and political (Charamis, 2018). IRs was thought as the relation between individual workers and individual employers (Child, 1964). Individual workers bargained regarding the terms and conditions of their work with the individual employers (Rayhan, Saha & Hassan, 2014). The birth and growth of workers' and employers' association has helped IRs to become institutionalized (Paras & Curteza, 2018). At present the IRs become the collective relationship among workers and their association, employers within the statutory regulations framework governed by the government (Deakin & Morris, 2012; Poole, 2013). The field of both social practice and academic study of IRs and their dynamism, signifies the supervision, control and management of the relationship between work and employment (Blyton & Turnbull, 2004).

The workers and their associations, and employers are the central institution to shape the rule of employment through collective bargaining in many countries (Godard, 2002). However, the scope of IRs is much wider than this; indeed, it covers the entire spectrum of problems concerning the ILO (Bratton & Gold, 2017). Working lives are regulated in all countries and at all times, and the development and implementation of such laws involve an authority (Clark, 2010). GAs as an institution regulate of employment and labor market issues in order to overcome the multiple collective action problems that affect both employers and workers (Hyman, 2008).

According to the John Dunlop (1958), this is the tripartite model of collective bargaining of having TUs, employers and GAs. Kochan, McKersie & Cappelli (1984) defined IRs as a system of strategic choice, is combined of organizing union, strategic HRM, policies and laws, corporate campaign with workers rights. Kochan et al. (1984) mentioned that the strategic choice theory offered an alternative that stressed decision-making through the group of individuals and communities within organizations, often serving their own interests that dynamically affected the growth of IRs. John Dunlop's paradigm in his IRS (1958) defined the concept of IRs with three actors: unions, employers and the government. Arumugam and Balasundaram (2010) stated that good IRs means industrial peace that is needed for better and higher production.

Industrial relations plays a major role in the establishment and maintenance of industrial democracy (Absar, 2012), and is essential to enhancing productivity in industrial enterprises. Generally, IRs cover the areas such as the role of employers, role of GAs, labor laws, courts, TUs, collective bargaining, grievance handling procedure, settlement of industrial disputes and etc (Hayman, 2008). IRs influenced by the characteristics of low level of consciousness among the laborers regarding rights such as laws, and trade unionism, high rate of illiteracy of workers, low level of decision making involvement of workers, high exploitation of workers, government and political interferences, low level of employment, and low labor productivity (Absar, 2012). In addition of John Dunlop, as the importers of finished goods, IBs at present the most impressive actor of IRs in the RMG industry of Bangladesh (Hossain & Arefin, 2015).

Table 2.2: Literature about Industrial Relations

Author & Year	Article/Journal/Title	Key Findings
(Hyman 1975)	What is Industrial Relations?	In this study some clear definitions of IRs, and its scope and content are discussed.
(Marsden 1995)	The impact of industrial relations practices on employment and unemployment	This study analyzed a number of policy suggestions for encouraging reform of IRs systems
(Bellemare 2000)	End users: actors in the industrial relations system?	An empirical model of the IRs actors was proposed in the paper.
(Kochan 2004)	Collective actors in industrial relations: what future?	The researcher focused on the actors of IRs systems and their collective relations.
(Kaufman 2004)	Employment relations and the employment relations system: a guide to theorizing	The researcher discussed the concept of IRs and its actors in collective bargaining process.
(Woolfson, Calite & Kallaste 2008)	Employee 'voice' and working environment in post-communist New Member States: an empirical analysis of Estonia,	The study examined the voice of employees in the industrial sector in terms of health and safety at work.

Author & Year	Article/Journal/Title	Key Findings
	Latvia and Lithuania	
(Edwards 2009)	Industrial relations: theory and practice.	This study covered the interaction with employment and the area of IRs.
(Lee 2009)	Industrial relations and collective bargaining in China	This paper is part of a comparative analysis which explores trends in IRs in different countries and regions of the world.
(Poole 2013)	Industrial relations: origins and patterns of national diversity	This empirical IRs study provides an analysis of a broad spectrum of IRs anomalies..
(Saini 2014)	Indian industrial relations law: Case for reform	This article discussed the employee relations including assumptions, social justice and industrial peace for shifting towards global competition, productivity, efficiency and mutual cooperation.
(Kurubetti & Nagendra 2014)	Industrial Relations at Cummins India Limited-A Case Study	The writers described the problems of labor relations, including conditions of employment such as wages , working hours, wage leave, health and safety administrative measures, lay-offs, dismissal retirements, etc., legislation related to these practices, workplace rights rules, social security, IRs, concerns relating to the involvement of employees in management, collective bargaining.
(Raju 2015)	Industrial Relations as a strategy for enhancing organizational productivity & performance	The study found that good understanding between employee and management improves productivity and resolved grievances and conflicts in an amicable manner.
(Singh 2015)	An Exploratory Study On Factors Affecting Industrial Relation With Reference To Employees Morale And Productivity	The study revealed that IRs, employee performance, and efficiency are strongly linked.

Author & Year	Article/Journal/Title	Key Findings
(Obisi 2016)	Disputes resolution through social dialogue: evidence from Nigerian organizations	The study showed that employers and employees along with the government are the key stakeholders to improve the working conditions of labor and industrial harmony.
(Yasmin & Shoru 2017)	The Industrial Relation in Bangladesh and India: A Comparative Analysis	The researchers defined IRs as the relationships among employers, workers and TUs relates to collective bargaining, the involvement of workers in decision-making, and the arbitration of grievances and conflicts.
(Duara & Mallick 2019)	Women Workers & Industrial Relations in Tea Estates of Assam	The paper showed the IRs scenario indentifying the major causes of work conditions, especially of the health hazards of women workers.
(Gough 2020)	Employee Voice at Work. Journal of Industrial Relations	This study provided the understanding of employment relations, human resource management, and organizational behavior and their integration for IRs.
(Pohler 2020)	A Field in Flux: Sixty Years of Industrial Relations	This study described the IRs system to provide voice for workers to improve wages and working conditions.

Source: Adapted by the Author

2.3.1 Different Actors of Industrial Relations

An actor in IRs can be defined as a person or community or institution who through its behavior and actions, can directly influence the process of IRs (Bellemore, 2000). One must not only take on the steps to be a true actor, but also have the opportunity to encourage other actors to take into consideration one's actions and react favorably to any of one's desires or demands for the greater sake (Heery & Frege, 2006). The attachment of an agent of IRs is commonly regarded to produce number of effects, which from a structural point of view can have greater or lesser significance (Kochan, 2004). An object must be able to accomplish its

aims on occasion in order to be an actor, or to create transformations in the IRs in which it functions (Bellemore, 2000). John Dunlop has also set out the notion of actors, and but he focused on just three actors such TUs, employers, and GAs. The idea of another actor such as buyer has been the focus of renewed interest, and the confrontation of which with other actors can help explain and justify many recent developments and the streamlining of in IRs in the RMG sector (Hopkins & Dawson, 2016).

2.3.1.1 Trade Unions

The right to organize is not only a core labor right in itself, but it is also a crucial facilitator and guarantor of related labor rights (Adler-Milstein et al., 2013). Wherever workers are prevented from exercising their right to unite and express concerns about conditions of work, other labor rights, such as minimum wages, overtime payment and non-discrimination come under threat (Pratt, 2008). TUs include an essential work organization component, which seems to be needed for their feasibility (Child, Loveridge & Warner, 2018). A TU can be basically termed as an association of employees to make stronger their efforts in bargaining with their correspondents (Shrestha, 2012).

The trade union is a voluntary employee association to defend and uphold their mutual interests through collective bargaining and solve their problems created by the industry (Bellemare, 2000). It is an important part of the relationship between employers and employees (Rigby & O'Brien-Smith, 2010). The central function of TUs is to bargain with their employers to ensure fair wages, security of job and better working conditions for their members (Dundon, Wilkinson, Marchington & Ackers, 2004). They also protect their members from any injustice and exploitation, and against any violation by their employers (Chen, 2003).

Flanders (1975) stated that trade unionism is an essential part of complicated yet overall smoothly working system of IRs. Hossain et al. (2010) mentioned that TUs means any combination of employees or employers organized primarily for the reason of governing the relationship between employees and employers or between employees and employers

in order to enforce restrictive requirements on the conduct of any employees or company and involves a coalition of two or more TUs. TUs mean union of employees or employers organized and registered in compliance with chapter XIII of BLA 2006 which includes a TU federation (BLA, 2006).

The feature of union revolts the interaction among four gears such as organization, interest, power and agenda (Hyman, 1996). The primary task of forming, developing and perusing TUs are to defend and improve the conditions of work life of their members (Gumbrell-McCormick & Hyman, 2013; Nowak, 2015). Freedom of association and equality to assemble is internationally recognized as fundamental human rights and TUs are perceived to be one of the most important social forces behind democracy (Chelghoum, Takeda, Wilczek & Homberg, 2016). The TU is an association of employers or staff who unite to pursue shared goals in fields such as working practices and to defend and advance their mutual interests through collective action (Malinowski, Minkler & Stock, 2015).

The TUs negotiate employee contracts with the employer or government on behalf of the members of the unions to strengthen working conditions and help employees achieve job protection (Bryson, Barth & Dale-Olsen, 2013). Unionization as a coalition of equally skilled employees can improve a workforce's productivity and encouragement by improving the quality of employment or by shifting the attitude of workers regarding their employment (Brown & Medoff, 2016). Both employees and employers have some bargaining power, bargaining may be either between individuals and management, or between an agent of the workers and management, where the agent could be a TU (Booth, 2014).

The important role and responsibility that union could continue to play in building proper workers' awareness and action on Occupational Safety and Health (OSH), building a preventative culture and helping establish OSH committees in workplaces (Ahammad, Shanta,

Hossain & Naim, 2017). TUs are a centre piece in building safer workplaces (ILO, 2018). The relations between unions and other elements such as unions and working class party relations, workshop organizations are either weak or absent (Gourevitch, Martin, Ross, Bornstein, Markovits & Allen, 2016). Union growth is a positive development and will help to ensure fair workplace conditions for RMG workers (Kersley, Alpin, Forth, Bryson, Bewley, Dix & Oxenbridge, 2013).

In a manufacturing company, IRs play a significant role in achieving the output goals of an entrepreneur (Ahmed, Raihan, & Islam, 2013). An atmosphere of cooperative IRs has been closely and continuously associated with better workplace relations and increased organizational performance (Ashwin & Clarke, 2002). Cordial IRs boosts output, while nagging disputes not only have an adverse impact on productivity, but can also result in an organizational disaster (Hopner, 2005). A harmonious atmosphere of IRs has been related to a higher degree of corporate engagement and union allegiance (Deery et al., 1999). Together, the working environment and contextual variables are often defined as the climate of IRs and this term was used to understand workforce activity, attitudes, and relationships between TUs, employees, and employers (Clark, 1989).

Trade unionism is the core of IRs (Hyman, 2002). Angle and Perry (1986); Dhal (2011) found that the IRs is closely related to workers' loyalty to the TUs and to employers. Bacon and Blyton (2004) suggested that it needs the growth of TUs activity as the philosophy of mutual interests erodes the ability and the potential of union leaders to fight against employers; establish workers' terms and conditions, especially by undermining job security. TUs offer a platform for joint efforts by employees to uphold their mutual interest and form an important part of the interaction between actors in the field of IRs (Bellini, Burrioni & Dorigatti, 2018).

Table 2.3: Literature about Trade Unions and Industrial Relations

Authors & Year	Article/Journal/Title	Key Findings
(Passey & Passi 1990)	Role of Trade Unions: Need for New Attitudes, Beliefs and Practices	The article emphasized on the active role of TUs in the formulation of a structural policy to accelerate IRs instead of their traditional roles.
(Dundon & Eva 1998)	Trade unions and bargaining for skills	This paper suggested the roles and influences of TUs toward a new bargaining skill for prevailing IRs environment.
(Deery et al. 1999)	Industrial relations climate, attendance behavior and the role of trade unions	This paper chalked out the factors that have an effect on the progress of a co-operative IRs atmosphere.
(Faini 1999)	Trade unions and regional development	This paper focused on the roles that TUs play in the context of IRs.
(Ding, Goodall & Warner 2002)	Impact of economic reform on the role of trade unions in Chinese enterprises.	This thesis investigated the impact of TUs, in particular at the plant level, on industrial and labor relations.
(Johansson & Partanen 2002)	Role of trade unions in workplace health promotion	The authors advocated in defending and supporting workers and their TUs in strengthening their influence on workplace health promotion.
(Azam & Salmon 2004)	Strikes and political activism of trade unions: Theory and application to Bangladesh	This paper provided a simple theoretical framework for analyzing TUs activity to test its main implication.
(Fick 2009)	Not just collective bargaining: The role of trade unions in creating and maintaining a democratic society	This article explored the aspects of the TUs movement in developing industrial and labor relations.
(Hyman & Gumbrell-McCormick 2010)	Trade unions, politics and parties: is a new configuration possible?	This study concentrated on the role of TUs and their relationships with governments and political parties in the political arena.
(Findlay, Commander & Warhurst 2011)	The role of trade unions in effective skills utilization: three Scottish case studies. In a report for Scottish Union Learning and the Scottish Trades Union Congress	This study investigated the possible roles of TUs in leading to a greater utilization of expertise in workplaces.

Authors &Year	Article/Journal/Title	Key Findings
(Saundry, Jones & Antcliff 2011)	Discipline, representation and dispute resolution—exploring the role of trade unions and employee companions in workplace discipline	This study indicated that both the TUs protect the rights of the staff and promote the informal settlement of disciplinary disputes in the IRs.
(Stefanovic 2012)	Role of trade unions in the prevention of mobbing (or bullying)	This research showed that TUs fight for their members who are the primary and greatest of victims.
(Bryson et al. 2013)	effects of organizational change on worker well-being and the moderating role of trade unions	The researchers found that TUs ameliorate job-related anxiety of employees in the workplace.
(Islam & Asaduzzaman 2015)	Legal framework for trade unionism in Bangladesh	This study emphasized the TUs activities as a means of maintaining a sustainable employment relationship for the benefit of smooth IRs between workers and employers.
(Rodin 2016)	'Developmental talk's confession: The role of trade unions in workplace governance	This thesis addressed the role of TUs organizations looking at the performance appraisal trend.
(Ahammad et al. 2017)	Trade Unions and Industrial Relations in Bangladesh: Human Resource Aspect	The analysis of this study found that the TUs offer a forum for concerted industrial action and represent an important part of the employer-employee relationship.
(Brigden 2018)	Work, Identity and Trade Union Responses and Strategies	The authors explored historical interactions between unions and these workers and examined contemporary strategies.
(Wibberley, Bennett, Jones & Hollinrake, 2018)	The role of trade unions in supporting victims of domestic violence in the workplace	The paper explored the responses and effects of TUs in the workplace.

Source: Adapted by the Author

In order to terminate long-standing injustice, the people of Bangladesh had to fight a bloody war against the brutal Pakistani force for nine long months in 1971 and got an independent Bangladesh in December 16, 1971 (Lewis, 2011). After its birth, the Constitution of Bangladesh is formed in 1972 in where Fundamental rights include, all are equal before the law; prohibition of bias on grounds of religion, color, ethnicity, sex or place of birth; equal rights in matters of the opportunity for public employment; protection of rights relating to sovereignty of speech and liberty to join associations; freedom to pursue any profession; security of life and personal freedom (Al Faruque, 2009).

In 1972, the new government of Bangladesh declared a labor policy with the recommendation of reducing the TUs activities in welfare organizations (Mian & Rashid, 2014). In May 1972, the government passed Presidential order no. 55 for the nationalized industries regarding the prohibition of the right to collective bargaining and strike for six months (Al Faruque, 2009). In 1973, as provided in 1969 by the Industrial Relations Ordinance (IRO), the freedom to strike and lockout be revoked. Meanwhile the Emergency Power Law was enacted in 1974 and absolutely abolished workers' political rights by banning TUs practices such as strikes, lockouts, collective bargaining (Al Faruque, 2009; Mizan, 2018).

However, there were only three TUs in the RMG sector of Bangladesh until 1997 (Ferdous, 2011). In 2013, 87 amendments are adopted by the government to the BLA 2006 (Ahmed, 2013). The latest reforms speed up the process for enrollment at the TUs and encourage collective bargaining (Rahim & Islam, 2019). According to the data of Department of Labor, 75 new unions were formed in 2013, 150 in 2014, and 75 new registrations were made in the year of 2015, the numbers of registration in 2016 become 80 where in 2017 it was 83. In 2018 total numbers of TUs, registrations were 110 and the numbers increased to 160 in 2019. Until June 30, 2020, total 909 of TUs were registered in the RMG sector (DoL, 2020). TUs play a valuable role in establishing jovial relationships between owners and employees in the Bangladesh RMG market (Hasan et al., 2018).

Trade unions help workers to address members' problems; make them aware of their responsibilities and rights to create a sound workplace environment (Gupta, 2014). It bargains with management over the privileges and rewards of the workers (Ullah, 2015). The TUs draw awareness from community, GAs and others concerning if the employers do not value their claim (Klasen, 2019). Therefore, TU is an effective medium of employees to raise their voice and protection of the rights of workers in Bangladesh's RMG sector (Al Faruque, 2009). It is equally crucial that workers continue to recognize TU as an opportunity and collaborate with them to build a workplace unity that benefits both employees and businesses (Alam, Mamun & Islam, 2004).

Table 2.4: Literature about Trade Unionism in RMG of Bangladesh

Authors &Year	Article/Journal/Title	Key Findings
(Ahamed 2012)	Can trade unions play an effective role in defending workers' rights in the Bangladesh ready-made garment industry?	This paper focused on the dynamic roles of TUs to improve labor relations and create a congenial work environment in RMG of Bangladesh.
(Rashid, Ahmad &Sarkar 2014)	Compliance of safety, health and welfare in RMG of Bangladesh	This study showed the roles of TUs for implementing safe and healthy working environment and ensures desired production or outcome of a RMG.
(Shoron 2015)	Workers' Safety in Bangladeshi Readymade Garments Industry	This study described the actions of TUs and other authorities involved in order to get better and safety RMG in Bangladesh.
(Karmaker & Saha 2016)	A case study on constraints affecting the productivity of readymade garment (RMG) industry in Bangladesh	The study recommended that the opportunity for Bangladesh to be the industry leader in the RMG sector through suitable recognition and captivating remedial actions against the challenges by the employers and TUs.
(Chowdhury 2017)	Women's rights and voice in the ready-made garments sector of Bangladesh: evidence from theory and practice	The study argued that insufficient implementation of regulations to ensure human rights as well as standards of ethics generally lacks the identity and interests of women employees in Bangladesh's elite-led RMG market.
(Islam 2017)	Gender Difference-How Does it	The study showed that there is growing proof of

Authors &Year	Article/Journal/Title	Key Findings
	Affect Trade Union Struggle? A Qualitative Study on Female Workers of Bangladeshi RMG Industries	shifting views among young woman unionists in taking on leadership roles together with their male colleagues in order to improve equality and gender diversity within TUs.
(Mausumi 2017)	Stakeholder Roles In Improving Occupational Health and Safety (OHS): A Case Study of Bangladesh Garment Industry	The paper found that making sound relationship among employers, workers, TUs and ensuring good governance improve the working environment and can build positive image of the RMG sector of Bangladesh.
(Ezaz 2018)	Impact of Repression of Trade Unions on Working Conditions: A Bangladesh Perspective	The focal quest of this research is to find whether the repression of TUs is the proximate cause of inability to improve conditions of work in RMG sector of Bangladesh.
(Moazzem & Azim 2018)	Workers' Organisations in RMG Enterprises: How to Address Institutional Challenges?	This paper reviewed that the challenges of institutionalization of workers' organizations in the RMG sector and puts forward suggestions for better functioning of these organizations.
(Nur 2019)	The Role of Trade Unions in Protecting Rights of Laborers in the Readymade Garments (RMG) Sector of Bangladesh: A Comparative Analysis of Bangladesh, Chinese and Indian Laws	This paper highlighted the insufficiency and problems of Bangladesh labor act in relation to TUs in assessment to legal requirements in the ILO conventions.

Source: Adapted by the Author

2.3.1.2 Employers

A single person or a company may represent many people (Bishop, 1957). The person or entity who hires other person to perform services on the basis of express or implied agreement is called as employer (Clark, 1968). The employers have the powers and rights to manage their employees. They have the ability to keep the workers in works under their supervisions (Moss & Tilly, 2001). The employers define the terms of employment and specify the contract (Summers, 2000) and also legally responsible for practices of working laws and regulations (Noe et al., 2015).

The responsibilities of the employers are to ensure the satisfactory work environment for the employees (Backhaus, Stone & Heiner, 2002). They have other privileges and responsibilities, such as setting off redundant staff, making business steps such as mergers, purchasing or closing down the company, and incorporating technical developments in operations. Employers motivate the employees to give their best and gaining their trusts and commitments (Cappelli, Bassi, Katz, Knoke, Osterman & Useem, 1997). They have the opportunity to improve the overall efficiency and ensuring effective communication among the employees and the management. The employers also deal with the issues of TUs, together with the bargaining of terms and conditions of employment with the employees' representatives, in order to allow for a sound IRs (McCleary et al., 2017).

As the most benefited actor in RMG sector, the employers of the factories has the responsibility to create and enable a good and safe working environment in the industry (KsiezaK, 2016). It must ensure the safety of its workers by taking sufficient action to fix the issues (Shea, Nakayama & Heymann, 2010). Some employers of the RMG industries start taking a more positive attitude regarding the workers and the working place (Baumann-Pauly, Nolan, Van Heerden & Samway, 2017). Some employers always try to ensure the congenial working environment by complying with the laws and regulations, inspection of factories for safety and security issues, provision of assistance to their staff and payment of compensation to victims (Khondker, Razzaque & Ahmed, 2005). The employers think that the employees' problem is their problem (Snape, Redman & Chen, 2000).

It is also alleged that it is the factory employers who are solely responsible for numerous factory accidents (Tsoi, 2010). They are accused of paying poor salaries, preventing staff from forming TUs, unable to construct and fire protection, bound to operate for long hours and unable to pay penalties for their carelessness to injury sufferers (Campaign, 2012). The RMG employers are dependent on employees (Hossan, Sarker & Afroze, 2012). The employers of RMG factories cannot utilize the large resource due to job dissatisfaction (Sarker & Afroze, 2014).

Proper working environments, fair pay, guaranteed hours of employment, benefits, and appreciation for equity will translate into happier and more productive jobs and reduced workforce turnover (Rahman & Siddiqui, 2015). RMG employers in Bangladesh should pay much more attention to monitoring compliance (Hossain & Arefin, 2015). The employers can introduce IRs activities and get many benefits (Kelly, 2012). The employers have introduced day care centers inside the factory premise for the children of the woman workers (Rahman & Siddiqui, 2015). It is indeed necessary for factory owners to have taken a more positive approach to the concerns of working people by ensuring fair representation in the workplace and understand the roles that TUs and workplace health committees can play in maintaining workers' safety standards (Sharma, 2015).

Table 2.5: Literature about Employers and Industrial Relations

Authors &Year	Article/Journal/Title	Key Findings
(Freeman & Kleiner 1990)	Employer behavior in the face of union organizing drives	The researchers pointed out the factors and outcomes of employers behavior in IRs in the organization.
(Wallerstein, Golden & Lange 1997)	Unions, employers' associations, and wage-setting institutions in Northern and Central Europe, 1950–1992	This paper presented new data on changes in the organization of unions, employers' associations, and collective bargaining.
(Davidov 2004)	Joint employer status in triangular employment relationships	The article examined the question of who should be considered the legal employer in employment relationships.
(Traxler 2004)	Employers, institutions and economic change: a crossnational comparison	The paper analyzes how the employers have actively tried to adjust themselves to the changing IRs situations.
(Silvia & Schroeder 2007)	Why are German employers' associations declining? Arguments and evidence	The research analyzed the response of employers to a more demanding world in view of the variety of literature on capitalism.
(Havard, Rorive & Sobczak 2009)	Client, employer and employee: Mapping a complex triangulation	The researchers proposed a categorization of the triangular situations among employers, employees, and government in IRs.

Authors &Year	Article/Journal/Title	Key Findings
(Gooberman,Hauptmeier & Heery 2019)	The decline of Employers' Associations in the UK, 1976–2014	This article described that employers regulate the employment relationship by participating in collective bargaining.
(Barry & Wilkinson 2011)	Reconceptualising employer associations under evolving employment relations: countervailing power revisited	The authors reviewed the literature on employer and explain the roles of the employers in coordinating their interests in employment relations.
(Batt, Nohara & Kwon 2010)	Employer strategies and wages in new service activities: a comparison of coordinated and liberal market economies	The authors showed the relationship between employers' strategies and wage outcomes in the IRs systems.
(Priyadarshi 2011)	Employer brand image as predictor of employee satisfaction, affective commitment & turnover	The study highlighted the preferred and existing levels of employers attributes.
(Hauptmeier 2015)	Employer and Worker Collective Action: A Comparative Study of Germany, South Africa, and the United States-by Andrew Lawrence	The author focused on employers' powers and attempt to identify the various factors that matter IRs.
(Allen 2016)	Employer and Worker Collective Action: A Comparative Study of Germany, South Africa, and the United States	The author explained, on the one hand, the relationships between employers and unions, and, on the other, employers.
(Ahammad et al. 2017)	Trade Unions and Industrial Relations in Bangladesh: Human Resource Aspect	This research work discussed that the most common purpose of employers in improving and maintaining the working conditions of an employment.
(Sheldon 2018)	Employers, managers and employment relations	The paper examined employers' responses to collective bargaining in IRs using strategic choice and resource dependence theories.

Source: Adapted by the Author

2.3.1.3 Government Agents

Government refers to a group of people that governs a community or unit (Fallon, 1992). It establishes and administers policies, programs, and exercises executive, political, and sovereign powers through state customs, institutions, and laws (Sarooshi, 2003). Uzoh (2015) defined government as a collective that exercises sovereign control over a country, community, society or other body of citizens and is responsible for law making and regulation, currency management and protection of the population from external threats, and may have other duties or advantages.

Government plays a central role in the development of IRs systems by implementing and systematizing structural reform through a collection of specific public capacities; narrating an objective analysis of the crisis in IRs; solving the joint action problems of employers and TUs; and predicting and establishing partnerships among private industrial actors; though it is necessary to not neglect the explicit repressive force of the government (Hayter & Lee, 2018). It plays roles of umpires, conciliators, arbitrators and administrators in the IRs (Badejo, 2011). Government as an actor tended to offer priority to economic policies over labor policies and restrict independent union production (Al Faruque, 2009). Labor rights are perceived as being inferior to government interests (Galenson, 1992). Kahn Freund (1967) said there might not be a major country in the world where the law played less important roles in shaping IRs.

Government has set up several agencies to assist it in the administration and control of the IRs system and these instruments are called GAs (Derthick, 2011). GAs can easily get the cooperation of organization in IRs programs activities (Abun, Magallanes, Agoot & Benedict, 2018). GAs refers to all organs established by government in its efforts to supervise, control, and administer government policies (Okaka & Eriaguna, 2011). According to Fashoyin (2005), IRs is not restricted to what happens between employers and workers in public and private enterprises, or to the implementation of labor laws and provision of collective agreements. Fajana (2005) defined IRs as encompassing every conceivable feature affecting the management of employees (human resources) including activities of government or its agents in such manpower management.

The GAs acts in the IRS as both a planner and an administrator (Fudge, 2015). The GAs are responsible for maintaining a fair labor policy and has a position to play as an employer in the public sector in providing an optimal atmosphere for collective bargaining and in preserving association rights (Budeli, 2010). Maintaining a positive IRs in society is fundamentally dependent on the position of the government as an agent in the structure of IRs as it is the government's responsibility to devise labor laws and regulations, to enforce them, and therefore to maintain fairness such that neither the employees nor the employers suffer (Müller-Jentsch, 2004). It is evident that any kind of government interference in labor conflicts will weaken the partnership between employers and employees (Colling & Terry, 2010; Rogowski, 2010).

The system of IRs in Bangladesh is distinguished by the prevailing position that the GAs plays in it (Al Faruque, 2009). Being the single largest employer, the IRs strategies it pursues for the employers have a deciding impact on the condition of IRs all through the country (Arumugam & Balasundaram, 2010). The GAs' intervention in TUs vestige a persistent aspect in IRs of Bangladesh (Singh, 2015). The GAs also play a leading role in different tripartite bodies (Hyman, 2008). In Bangladesh, there are many authorities and agencies assiduous for IRs (Absar, 2012). The Ministry of Labor and Employment (MoLE) is responsible for formulating the strategies and managing the divisions and agencies that are under it. The MoLE has implementation departments such as Department of Labor (DoL), Department of Inspection for Factories and Establishments (DIFE), Manpower Bureau, Jobs and Training, Minimum Wages Board (MWB), Industrial Relations Centre (IRC), Labor Appeal Tribunal and seven Labor Courts (Al Faruque, 2009).

The DoL was founded in 1983 is playing it is as the agent of government in IRs of Bangladesh. The department has as its director, an associate executive, a joint chief and Labor's assistant secretary. Under the DoL there are four divisional offices, in which there are 16 regional offices in various industrial regions, one welfare division at Sreemongal for Sylhet tea garden employees, and 28 labor welfare centers at different industrial belts (Al Faruque, 2009). As the agent of government in IRs, DoL's assigned functions are:

- Provide TU registration;
- Provide industry-based TU federation registration;
- Provide national based TU federation registration;
- Provide national-based TU confederation registration;
- Change of constitution, name and address in respect of self-explanatory application;
Issuance of attested copy of various documents related to the union, issuance of second copy of certificate of registration;
- To form participating committees and supervise the functions;
- Determining Collective Bargaining Agents (CBA);
- Oversee the selection of the executive committee;
- Dispute resolution;
- Collection and supply of data related to factories and industrial establishments;
- Disposal of allegations of unfair labor practices raised by any employer or worker;
- Provide 4 (four) weeks training and allowances on labor law, IRs, labor administration, functions of ILO, various labor conventions and ongoing domestic and international labor related courses;
- Provide one-week training courses and training allowances on labor law, workers' rights and responsibilities, productivity, work environment, OHS, etc. through conducting labor education training courses;
- Distribute free medical services and medicines to workers and their families;
- Health and family welfare and population control activities for workers and their family members;
- Entertainment of workers and their family members through newspapers, TV, books, sports equipment;
- Advice on what to do to enhance the workers' standards of living and visit the colony of workers; and
- Organizing and implementing education programs for workers and training in the labor administration.

The DIFE is working to ensure that an increasing number of working people in the country have legal rights and a safe and secure working atmosphere. In particular, the DIFE is playing an important role in ensuring compliance in the RMG factories. The vision of DIFE is to ensure safe workplace, decent working environment and improved living standards for workers. Moreover, it works for creating a better working environment for workers, implementation of BLA 2006 and Bangladesh Labor Rules (BLR) 2015, elimination of child labor and ensuring the occupational health and safety of employees in the workplace and the enforcement in different sectors of the declared minimum wage (DoL, 2020).

The beginning of the Bangladesh Minimum wages Board lies in Convention No. 26 and Recommendation No. 30, adopted by the ILO at its 1928 general Conference. The ILO undertook by Convention No. 26 to create or retain machinery by which minimum wages rate that could be set for workers on industries where there was no provision for effective wage control by collective agreement or otherwise. In compliance with Recommendation No. 30 of the ILO, the ILO recommended that minimum wage fixation machinery should function by means of an inquiry into the related industry conditions with employers and employees, where full consideration should be given to views on all matters relating to the setting of minimum wage rate. In that regard, it can be claimed that the MWB is the only legislative government wages-fixing device that plays vital roles in RMG sector of Bangladesh (MoLe, 2018).

Together with the employers of RMG factories, the GAs has been accused of illicit carelessness mostly because of their failure to hold these factories responsible or to assurance of basic workers' rights (Bakht & Hossain, 2017). Noteworthy questions have also been asked regarding recurrent protection problems in the RMG sector in Bangladesh in the light of broader human rights issues affecting global supply chains (Siddiqui & Uddin, 2016). After the Rana Plaza accident in 2013, the Bangladesh government has been giving special importance to institutionalize the issue of safety in the RMG sector. As part of this effort, the safety of more than 3,500 export-oriented RMG factories has been assessed between 2013 and 2015 to assess the structure, electrical and fire safety of the building (DoL, 2019). Such initiatives are carried out under the Accord, Alliance and the Government of Bangladesh

National Initiative conducted in collaboration with the ILO. The RCC has been set up under the DIFE in collaboration with other industry regulators to conduct remedial actions on RMG factories valued under the government initiative (DoL, 2020).

Table 2.6: Literature about Government Agents in Industrial Relations and RMG of Bangladesh

Authors & Year	Article/Journal/Title	Key Findings
(Ungku Abdul Aziz 1967)	Government and industrial relations in Malaysia	This paper found that there are six significant roles that the GAs plays in the IRs game. They are the legislator, administrator, peacemaker, participant, adjudicator, and guardian.
(Adams 1992)	The role of the state in industrial relations	This book discussed that government is an actor of IRs system and its action has been treated almost exclusively as an independent variable and only rarely as the phenomenon to be explained.
(Marshall 1992)	The future role of government in industrial relations	The paper described the potential position of policy in labor relations depends on the choices taken by companies, employees, and particularly GAs.
(Hoque & Hopper 1997)	Political and industrial relations turbulence, competition and budgeting in the nationalized jute mills of Bangladesh	The study demonstrated how political instability and labor disputes would make the structured budgeting and control mechanisms inefficient for internal management.
(Traxler 1999)	The state in industrial relations: A cross-national analysis of developments and socioeconomic effects	This is a comparative study of the three main roles of the state in IRs: the state as employer in the public sector, state intervention in private-sector-wage bargaining, and the procedural role of defining a legal framework for IRs.
(Kuruville & Verma 2006)	International labor standards, soft regulation, and national government roles	The researchers described the roles of government based on labor standards.
(Hyman 2008)	The state in industrial relations	This study focused on the roles of government and the impacts of politics on the IRs systems.
(Quader, Wazed, Aziz & Mojumder 2013)	Industrial sickness in Bangladesh: An empirical analysis	The study revealed that the potentiality and effectiveness of the government policy in controlling the industrial sickness in

Authors & Year	Article/Journal/Title	Key Findings
		Bangladesh and will put forward certain suggestions to revamp the policy framework so that the effective tackle must be taken against the problems.
(Uddin 2014)	Role of Labor Administration Departments in Protecting Labor Rights: Bangladesh Perspective	This article examined the structural and legal weakness of the labor department of Government and suggests something new which can the fate of the laborers in Bangladesh.
(Ravenswood & Kaine 2015)	The role of government in influencing labor conditions through the procurement of services: Some political challenges	The authors argued that government's position in the job relationship needs to be knowledge provided in order to understand its organization as an indirect contractor in public procurement, and its purchasing control.
(Mausumi 2017)	Role of Government in Promoting Corporate Social Responsibility: Analysis of the Bangladesh Ready-made Garment (RMG) Industry	The author discussed the roles of actors like government and RMG employers from the standpoints of improving safety concerns.
(Mausumi 2018)	Role of Government in Promoting Corporate Social Responsibility: Analysis of the Bangladesh Ready-made Garment (RMG) Industry.	This study focused on the role of government and its agents in promoting CSR in the RMG of Bangladesh.
(Mausumi & Rahman 2018)	Impact of Stakeholder Initiatives: Bangladesh Garment Industry	The researchers of this study noted GA's role in improving the overall working conditions of the factory and the rights of employees in the RMG industry in Bangladesh.
(Rahman 2019)	Post-Rana Plaza responses: Changing role of the Bangladeshi government	This study provided unique insights into the factors that GAs foster and prevents change in workplace policies designed to improve labor standards in RMG factories.
(Chowdhury & Rahel 2020)	The legal aspect of industrial relations practice in Bangladesh	This study aimed to argued regarding the gap between the roles of GAs in RMG of Bangladesh and the existing laws relating to industrial practices in Bangladesh.

Source: Adapted by the Author

2.3.1.4 International Buyers

In the world, in terms dressing, individuals in different areas have their own styles, which symbolize their culture and status (Rayhan, Saha & Hassan, 2014). Bellemare (2000) concluded that end-users (buyers) also constitute actor within IRs in an essential contribution, to the degree that they have a persistent and substantial impact on the type of the working relationship and the actions of employees, employers and state institutions. There is also new space for exploring the role of fourth parties in settling conflicts (Heery & Frege, 2006). The combined consequences of the system as a part of the working arrangement and the outsourcing of conflict settlement have created new entrants with resources (Kochan, 2004). If they influence the IRs mechanism or the causal forces employed by other actors in the IRs directly or indirectly by their actions, IBs may also be called bonafide actor in the IRs.

In the apparel sector, IBs are considered as the important actor because without IBs no transactions will be held. In this respect, IBs holds supreme power to influence sellers (Hossain & Arefin 2015). In general, buying and selling companies put emphasis on close interaction, rather than take part in the market where they can get hold of benefits in the form of cost diminution or increased revenues (Ford, 1984). A number of scholarly and media articles have pointed to the plea of Bangladesh as an prospect for IBs from the US and the EU to branch out their sources of RMG in the world market (Abernathy, Volpe & Weil, 2006).

The sellers or the manufacturers pay significant attention to the IBs because they are most powerful actor (Bellemore, 2000). The manufacturers have to meet all requirements of IBs from the very beginning of production to the shipment. Otherwise, sellers could face tremendous financial losses and lose their credibility in the marketplace (Rayhan et al., 2014). The IBs, especially in the RMG, enforce a range of guidelines relating not only to order-related but also to RMG producers, such as workplace safety, working hours, production procedure, workplace climate, quality maintenance and control, contamination of the environment, collection of raw materials, social responsibility (Shumon, Halim, Rahman & Ahsan, 2019). Bangladesh has

therefore been alerted by many global brand retailers (IBs) to ensure basic labor rights (social compliance) and step-by-step enforcement of all industry compliance requirements (Hasan, Haque & Khan, 2020).

After the Rana Plaza collapse, all IBs are very much concern regarding the workplace environment and the rights of the workers (Hasan, 2017). They are imposing the compliance issues with their CoC regarding the environment of workplace and workers rights before placing their orders for the RMG of Bangladesh. At present, the exporters or the manufacturers are not giving their attention towards the quality of the products but also the working environment, worker health and safety as recommended by the IBs in compliance with the CoC (Sarkar, Qian & Peau, 2020). Therefore, the RMG must be developed so that the impression of the sweatshop is completely taken care of and the CoC must be expanded to achieve the objectives of social compliance issues (Haq, 2018). In his report, Haider (2007) claimed that clients, social workers, welfare agencies, and brand name IBs are more relevant in terms of social enforcement issues. The IBs in RMG industry are now very particular about their CoC (Alam et al., 2018).

As earlier stated, that the RMG industry is one of the key sectors of Bangladesh that is earning the highest income from the foreign regime since last 25 years (Hossain & Arefin 2015). Though it began journey in 1980 (BGMEA, 2019), it was able to build a reputation in the global apparel market and become one of the key export sectors of the country (Uddin & Jahed, 2007). In South Asia, with India as its biggest competitors, SriLanka was the main exporter, but Sri Lanka's civil war, IBs and the investors diverted their attention to RMG of Bangladesh (Buncombe, 2009). In a year, IBs visit factory maximum more than 5 times. Labor standards enforcement in Bangladesh takes place largely through the market mechanism. This mechanism is increasingly shaped by the corporate CoC of major IBs and multi-stakeholder initiatives, including the Fair Labor Association (FLA) that seek to improve working conditions (Berik & Rodgers, 2009).

In response to buyer pressure to reduce production costs in cutting and making, apparel manufacturers reportedly have doubled their efforts to increase productivity and reduce wastage of fabric/apparel without reducing wages (Rahman, Moazzem & Hossain, 2009). Shumon, Rahman and Ahsan (2018) mentioned that in future the stability of RMG industry of Bangladesh depends on the satisfaction of IBs. It is alleged that the rights of the workers in Bangladesh's RMG industry is significantly violated as a result of IBs putting pressure on the respective industry to ensure that their CoC is complied with before placing an order (Rashid et al., 2014).

Faced with anti-sweatshop campaigns and exposure of child labor and depressing working conditions in their supply chains, many IBs have come to adopt CoC and monitoring procedures in the factories. Previous researches have brought an increased focus on viewing the IBs as an actor in the IRs field. A large, mostly qualitative and descriptive literature has studied by Appelbaum and Gereffi (1994), Bernard, Moxnes and Ulltveit-Moe (2018b), Cajal-Grossi, Macchiavello and Noguera (2019) argued that as one of the key actors in the RMG industry, IBs produce more demand for a safe, productive, innovative work climate because it develops meaningful employee relationships, decreases employee attrition rates and workplace strife, boosts employee morale, raises outsider involvement, develops desirable business prestige. IBs auditing plays an important part in changing the workplace, as RMG owners strive to obey laws and regulations throughout buyers' auditing to please them and preserve their orders (Hossian & Arefin, 2015).

Baral (2010) addressed that a basic and essential prerequisite for the social enforcement of RMG factories for almost all international RMG buyers which ensure labor rights based on buyers' CoC. RMG factories should comply compliance issues just not for profitability but also for human rights protection. Ahmed (2009) showed that the future sustainability of the RMG industry relies on IBs fulfillment and satisfying their demands. The IBs have given more attention towards the environment of RMG industry of Bangladesh because it

establishes productive relationships with staff, it decreases employee turnover rates and civil unrest, boosts employee morale, raises the attention of investors, generates valuable company prestige (Ahmed & Nathan, 2016). Therefore, enforcement concerns of the IBs are fundamental to the needs of the owners and staff, but are expensive to enforce at the same time.

Table 2.7: Literature about International Buyers in RMG

Authors & Year	Article/Journal/Title	Key Findings
(Rahman & Hossain 2010)	Compliance practices in garment industries in Dhaka city	This analysis revealed that Bangladesh's RMG industry has a close relationship between compliance and productivity.
(Baral 2010)	Comparative study of compliant & non-compliant RMG factories in Bangladesh	The researcher argued that the compliance criteria of IBs are the primary tools in order to preserve the dynamism of Bangladesh's RMG industry.
(Hossain et al. 2012)	Recent unrest in the RMG sector of Bangladesh: is this an outcome of poor labour practices?	The researchers of this study mentioned the immense pressure from IBs for compliance with their CoC which emphasis on enhancing the work environment in factories.
(Rayhan et al. 2014)	Factors Affecting the Customer Buying Behavior in Relation to Readymade Garments in Bangladesh	The researchers found that understanding the IBs' behavior is the basic strategy to create a success and congenial environment for the RMG industry of Bangladesh.
(Hossain & Arefin 2015)	The Role of Buyers Compliance to Improve Workplace Environment of Garments Factories in Bangladesh	The researchers described the roles of IB in RMG industry of Bangladesh in improving the workplace environment.
(Hossain & Roy 2016)	Supply chain management for sustainable RMG growth in Bangladesh	The study revealed comply of CoC of IBs in making decisions and plans in the RMG industry of Bangladesh.

Authors & Year	Article/Journal/Title	Key Findings
(Rahim 2017)	Improving social responsibility in RMG industries through a new governance approach in laws	The study concluded with a new approach to governance in laws that can increase social accountability in the RMG sector, where profit-driven multinational purchasing companies are either inadequate or skewed by GAs.
(Alam, Azim & Alias 2017)	Social compliance in ready-made garment industry in Bangladesh: Challenges for HR personnel	This study identified the effects of social compliance of IBs from the RMG workers' viewpoint on productivity.
(Alam, Alias & Azim 2018)	Social Compliance Factors (SCF) Affecting Employee Productivity (EP): An Empirical Study on RMG Industry in Bangladesh	The study identified the effect of social compliance factors prescribed by the IBs on productivity in the RMG industry of Bangladesh.

Source: Adapted by the Author

2.4 Indicating aspects of the Roles of Actors in RMG Industry

Previous research shows the actors' roles in different industries in various points of views and then industrial system as well as particular research point of views. Present study highlights on actors and IRs within the industrial internal points of view. Therefore, the particular asking issues such as regulatory framework practices, working environment, organize association, collective bargaining, dispute resolution, and buyers' codes of conduct practices are highlighted in here.

2.4.1 Regulatory Framework Practices

Conflict of interest is at the centre of the employment relation (Kelly, 2012). This conflict of interest is vested between the employees and the employers while the employees provide labor and employers invest capital (Edwards, 1995). The employers think that employees intended to take the shares of their profit (Bergström, 1970). The law plays a pivotal role in

controlling and managing such conflict of interest between the actors of IRs (Kaufman, 2010). It also helps to constitute and restrict the authority of both labor and capital (McCaghy, Capron, Jamieson & Carey, 2016).

It has an important influence on the allocation of capital and power within the firm (Arrfelt, Wiseman, McNamara & Hult, 2015). The legal rules permit workers and employers to take collective industrial actions (Colling & Terry, 2010). When the workers feel satisfied in their organization with proper practices of labor laws then it is possible to bring positive IRs (Duah & Danso, 2017). The employers seek maximum return on their investments by encouraging the workers in the organization to work in accordance with rules and regulations (Kaium, 2020).

In the view of labor laws, the capital and the labor both are equally important. The main objective of the labor laws is to create exclusive relation between capital and labor (Xi, 2019). Labor laws reflect on the connection to jobs. It includes the guidelines of how to negotiate a labor contract, what privileges and duties the actors of IRs have under such a contractual arrangement, how much the actors can dispose of such rights and duties by securing substitute provisions and, lastly, how to end a labor contract (Andrias, 2016). It is significant feature of labor laws that it protects the concerned parties from the possibilities of unfair treatment (Fleming & Peetz, 2005). This mediates certain facets of the employers-employees-workforces and unions relationship (Islam & Rahman, 2015).

The specifics of each country's IRs are analyzed in terms of the level of priority given to development as well as adaptation to local cultural norms and respect for human rights. The program is essentially the product of the democratic process: it owes nothing to common law or the overt control of TUs, workers and their organizations (Ahmed et al., 2013). There were many labor acts in previous but now it has only one complied labor act in Bangladesh. The name is Bangladesh Labor Act 2006 (Al Faruque, 2009). Government helps by formulating labor laws and rules, which structured the relation among the actors to secure harmony in the IRs (Abun et al., 2018).

The BLA 2006 is one of the very recent acts with major overhauling changes in the field of labor legislation, which is amended, in time-to-time last in 2018 in order to cope with the changes and overcoming the drawbacks (Schoen, 2019). In this act, the work policies are well developed and organized for securing sound IRs (Duah & Danso, 2017). Parliament passed the Bangladesh Labor Act 2006, with effect from 2006. Sections 3-9 of this Act include terms of jobs, employee status, certificates of appointment and identification card, service book, type of service book, entries in the service book, registry of staff and ticket and card provision (BLA, 2006). Sections 51-59 define the terms and requirements for cleanliness, ventilation and temperature, dust and smoke, waste and effluent treatment, overcrowding, illumination, potable water, latrines and urinals (BLA, 2006).

The safety and health of the workplace, including building and machinery safety, fire precaution, fencing of machinery, working on or near moving machinery, cranes and other lifting machinery, hoists and lifts, floors, stairs and accessories are mentioned in sections 61-72 (BLA, 2006). Sections 100-118 describe the rules and regulations for daily hours, rest or meal intervals, weekly hours, weekly holidays, weekly compensatory holidays, spread over, night shift, extra overtime allowances, casual leave, sick leave, annual wage leave, festival holidays (BLA, 2006).

The definition of salaries and compensation in sections 120-126 includes a broad description of salaries, obligation for payment of wages, determination of salary terms, reimbursement of wages, wages to be charged in existing coins or currency notes, deductions for non-customs duties (BLA, 2006). The parties feel a sense of pride of having the provisions regarding TUs in the BLA, 2006 (Himi & Rahman, 2013). TUs and IRs, disputes relating rules are laid in the sections 175-211. It narrates the rules and regulations governing the specific definition of workers, TUs of workers and employers, collective bargaining agents (CBA), participation committee, industrial disputes, lockout and strike (BLA, 2006). Sections 283-307 laid out the punishment for non-compliance with the order of the labor court, the punishment for child and

youth jobs, the penalty for unjust labor practices, the penalty for unlawful strike or lockout, the penalty for involvement in or incitement to go-slow, the penalty for general worker offences, the penalty for other offences (BLA, 2006).

It is true that this act is designed to create and enable sound IRs but most of the labor unrest was due to the lack of proper practices of regulations described in BLA 2006 (Himi & Rahman, 2013). This is attentive to the causes for labor unrest in the light of the BLA 2006, as labor unrest is a big problem for the development and survival of Bangladesh's RMG industries (Choudhury & Rahman, 2017). The organization should consider its actors when deciding how to use its resources according to the regulatory framework (Waters, Bortree & Tindall, 2013).

2.4.2 Working environment

Environment literally means surroundings (Attfield, 2014). Working environment means a location where a task is completed (Awan & Tahir, 2015). A working environment means structures, systems, processes, and tools where people work together for achieving organization objectives (Akintayo, 2012). Physical working environment includes work tools as well as air, noise and light and psychological is how work is organized and wellbeing at work (Reinhold & Tint, 2012). It also requires laws, regulations; culture, finances, working relationships, labor, and environmental factors both internally, and externally that affect how many employees perform their job functions (Hossain & Arefin, 2015).

The work environment is the sum of the interrelationship between the workers and the workforce and the environment in which the staff work (Akinyele, 2010). The actors have confidence that the organization can maintain its working environment accordingly that has significant impact upon employee performance and productivity (Waters et al., 2013). The conducive work environment guarantees the well-being of workers, which has also helped them to perform their duties with all the strength that could contribute to higher productivity (Ali, Ali & Adan, 2013). A safe, productive, constructive, and innovative work environment

is critical because it establishes good workplace relationships, decreases workplace attrition and job strife, improves staff satisfaction, improves outsiders' interest, and generates a desirable image for the business (Brunges & Foley-Brinza, 2014).

Every system of IRs represents a complex set of rules governing the workplace and the work community (Biagi, 1990). The nature of the rule does not change its basic character: determining the actors' position and regulating the actions of all actors in the workplace and the work environment. The actors in IRs systems are at any time considered to confront an environmental context (Dunlop, 1958). In a good IRs situation, the employees can communicate openly to other employees without hesitation (Abun et al., 2018).

Two of the biggest problems confronting the RMG industry today are to maintain health in the workforce and decent working standards for the millions of RMG employees (Hossain & Ahmed, 2013). The management ensures that everybody functions in the work environment in order to ensure sustainable socio-economic growth (Kaium, 2020), not only for the IB's interest but also for the betterment of the workers. The organization would accept any type of job assignment in order to keep working sound (Deery et al., 1999). It needs effective roles of TUs in negotiating wages and working conditions for the sound IRs (Fleming & Peetz, 2005). The government, the ILO and consumers operated together to strengthen working standards in apparel factories, and the workers' dissatisfaction over pay was therefore significantly stimulated through the introduction of the existing wage board award (Islam & Adnan, 2016).

2.4.3 Organizing association

Freedom to organize is a liberty fundamental of IRs (El-Haj, 2014). Chan (2013) explains freedom of association as the privilege of common citizens of shared interest to establish their organizations for the advancement of their interests. Right of association is the freedom of employees and employers to establish and participate openly respective bodies such as TUs, workers' organizations and workers' councils or committees for the promotion and protection

of job interests (Kolben, 2009; Rogers & Streeck, 2009). They are protected by the organization from the coercive control of government, the employers, or other self-interest strongholds. This independence provides opportunities for both employees and employers to determine their right to life, dignity, and discrimination security. The workers feel sense of pride being part of the TUs (Snape et al., 2000). It benefits both employees to create a cooperative working atmosphere sufficient to decrease deteriorating the workplace and improve employee morale, dedication and productivity (Landis & Grossett, 2014). The actors get a sense of personal accomplishment from their work for having the right to freedom of association (Duah & Danso, 2017). It is a critical element in the creation of associations and the collective bargaining capacity of industrial workers in developing economies, especially in labor-intensive industries (Budeli, 2010).

The Universal Declaration of Human Rights asserts the right to freedom of association (Swepston, 1998). At work, that means the right to form labor organizations freely. Workers who may not want to pursue these groups are still covered by their freedoms and will not be forced against their desire to do so. Freedom of association does not imply that companies are expected to unite workforces or to allow workers to work (Neumayer & De Soysa, 2006). This ensures managers do not intervene with the decision of an employee to enter an organization or discriminate against the employee for their preference (Swepston, 1998). In this respect, management encourages workers to participate in decisions, which affect their interest (Kaium, 2020).

The government always shows respect to organizing association for creating and enabling a sound IRs (Hossain & Arefin, 2015). In 1998, the ILO adopted a Declaration on Fundamental Principles and Rights at Work (DFPRW), describing the main conventions for respectable work (Rahim, 2017). Freedom of association and mutual acceptance of the right to collective representation resulting from ILO Conventions 87 and 98 are among the four basic values and freedoms at work (Dunning, 1998). The Constitution of Bangladesh recognizes freedom of

association as a constitutional right of the people of Bangladesh (Al Faruque, 2009). It is the main regulation regulating freedom of association and the right of factory workers to collective bargaining (Rahim & Islam, 2019).

2.4.4 Collective Bargaining

Workers and employers can freely relate to efficiently negotiate work relations (Heery, 2015). Workers' right to consult, harmonizes, and collectively agrees with their boss over their basic privileges and desires are commonly referred to as collective bargaining (Dunlop, 1993; Flanders, 1965). Collective bargaining is a procedure in which the selected employees and contractors negotiate with each other on the terms and conditions of work (Ackers, 2010). It helps to enter a mutual agreement that might change pay rates, working hours, working standards, workplace protection, health and social security, share of productivity (Ghayur, 2009).

ILO Convention No. 154 describes collective bargaining as relating, on the one hand, to any agreements taking place between an individual, an employer's association or one or more employer's organizations, and one or more workers' organizations to establish working practices and terms of jobs, to regulate ties between employers and employees and to regulate relations between employers and employees or their organizations (Hayter, 2011).

Collective bargaining concerns the relationships between TUs and GAs, and employers (Ackers, 2007). Bargaining is collective because chosen representatives of employees and employers act as bargaining agents (Ackers, 2015). A sense of self-respect and obligation among employees is generated by collective bargaining (Simms, 2015). It helps to ensure the resolution of grievances is timely and fair (Greene, 2015). It offers a versatile way to adapt salaries and job conditions to economic and technical shifts in the sector (Comboh, 2014). Workers feel satisfaction in the organization because there is opportunity for promotion (Abun et al., 2018). TUs may use collective bargaining to redress the differences between an employers and employees to seek a proportional share of the gains (Ebisui, 2012).

The right to collective bargaining with an employer strengthens the individual rights, equality and sovereignty of employees by providing them the ability to affect the setting of laws on the job and thereby obtain power over a significant element of their lives, namely their jobs (Jackson, Leopold, Tuck & Shams, 2016). Collective bargaining is encouraged in RMG (Absar, 2012) to ensure employers and workers equal voice in negotiations (Hayter, 2011; Marginson & Galetto, 2016). The employees believe in the willingness of management to deal with collective bargaining (Kaium, 2020). The result of these talks must be equal and reasonable (Kuruvilla & Zhang, 2016). All actors of IRs allow collective bargaining to establish a healthy working environment (Goldberg, Sander, Rogers & Cole, 2014). Standards of the ILO encourage collective bargaining and ensure good workplace conditions (Johnston & Land-Kazlauskas, 2018).

2.4.5 Dispute Resolution

Industrial relations may be harmonious or conflicting (Poole, 2013). Dispute is a natural matter in human life (Sarowar, 2015). It is inevitable that certain conflicts between the staff and management will occur (Islam, 2018; Khan, 2013). Dispute may be defined as conflict or dispute between two or more groups, owing to varying views, beliefs, attitudes and values (Rahim, 2010). Conflicts arise as a consequence of job contract provisions, working practices, pay structure and financial priorities (Sarowar, 2015). Industrial disputes include any disagreement or disparity between employers and workers, between employers and employees, or between employers and employees related to the job or working conditions of another individual (Deakin & Morris, 2012). Organizations provide opportunities to its parties to solve dispute that crates sound IRs. Conflict of interest between employers and employees is inevitable because a relationship of authority in the aim of both parties will at least result in conflicts (Pages & Ahsan, 2007).

Dispute resolution is a process for resolving differences between two or more actors or groups (Absar, 2012). Employees support one another where there is need for dispute resolution (Abun et al., 2018). Some of the key terms pertaining to conflict settlement, such as conciliation, consultation, and arbitration, which may be deemed widely common, can actually encompass

radically divergent procedures and circumstances, based on the various forms dispute resolution organizations work around the globe (Khaled, 2010). In the face of conflict and disciplinary measures to carry sound IRs, the company follows proper grievance management protocol (Alam et al., 2017).

Conciliation and mediation are processes by which a neutral entity offers support to the participants during talks or where discussions have achieved an impasse in order to aid them in achieving a compromise (Al Faruque, 2009). Arbitration is a process by which a third party (whether a particular arbitrator, a board of arbitrators or a court of arbitration) should not function as a court of law (Sarowar, 2015). The organization always appreciate the parties the involvement of dispute resolution (Deery et al., 1999).

The BLA 2006 provides important tools for minimizing industrial disputes by the intervention of conciliation and mediation, arbitration and labor adjudication (Sarowar, 2015). Moreover, the law provides another tool at the very initial stage of dispute such as participation committee to initiatives to enhance mutual trust, understanding and cooperation between employers and workers to ensure the enforcement of labor laws, to encourage a sense of order and to enforce and preserve protection, protection and working conditions for employees, and to take steps to improve the social system for employees and their families (Al Faruque, 2009). The actors of the RMG industry who are able to solve the dispute feel proud to tell others as the member of that organization (Deery et al., 1999).

2.4.6 Buyers' Codes of Conduct

Codes of conduct means fulfilling the requirements of specific standards, accepted practices, prescribed rules, laws and legislations, or the terms and conditions of a contract (Hossain & Arefin, 2015). Safety of workers in workplace is expected all over the world but an accident may endanger life of workers, safety of workers and negatively impact the livelihood of the workers and their families and those people who are living close to the industry (Azad, Hasan, Saha, Ahmmed, Moni & Kabir, 2019). The parties have to make the place safe where they work (Deery et al., 1999).

Occupational health and safety is one of the ILO's key goals, the definition of which has been established by the ILO and the WHO (Upadhyay & Pandey, 2016). The CoC really inspires all actors to do best job performance (Deery et al., 1999). Without workplace safety enforcement, it is almost impossible to ensure survival of business and therefore to succeed in a dynamic global market. For having sound IRs, the organization needs to disclose to the concerned parties regarding its compliance decisions (Alam et al., 2018). Finally compliance guarantees all human rights and services according to the IBs' CoC (Ahamed, 2013).

In the case of the industry, compliance refers to implement the state labor laws, related ILO conventions, CoC of buyers, and rules and regulations of the company (Rajapakshe, 2018) addressed that social compliance is a basic and key perquisites for almost all international RMG buyers, which ensure labor rights based on buyers' CoC. IBs takes feedback from the parties regarding their CoC and interests (Abun et al., 2018).

There are many types of hazards in manufacturing, and physical dangers such as burning, building collapse, etc. are closely connected to comply with structural and occupational health (Ansary & Barua, 2015). There are lots of benefits of complying IBs' CoC such as increase worker morale enhance productivity of labor, improve product quality, improve global image & recognition, and increase government-industry relation (Hasan, 2019). Management ensures that safety routines are planned that are meaningful and actually work. (Kaium, 2020).

2.5 Industrial Relations in RMG Industry of Bangladesh

It is mentioned earlier that the RMG industry is the most labor-intensive industry (Paras & Curteza, 2018) with low-wage labor cost. However, significant improvements in technology and computerization are supportive to its manufacturing. The RMG is a key manufacturing export for many developing countries (Keane & te Velde, 2008). In both volume and value, RMG goods from developing countries such as Bangladesh have experienced a quantitative leap (Hassan, 2017).

In addition, in the economic growth of these countries, the RMG sector has played at least four important roles. Firstly, vast numbers of labor are engaged. Secondly, it produces goods that fulfilled basic needs for large segments of the domestic population. Thirdly, despite low investment requirements, it serves to create resources for more technologically demanding output in other sectors and, finally, it finances imports of more advanced technologies by generating export earnings (Palpacuer, Gibbon & Thomsen, 2005). As well, the RMG sector was an interesting illustration of developed countries being able to dramatically raise and diversify exports with positive impacts on revenues, jobs and poverties (Razzaue, Eusuf & Shamannay, 2007).

Undoubtedly, Bangladesh's RMG act as an opportunity for the industry itself to be successful and help the economy (Hossain & Akter, 2015).The quality of work and workforce management is partly dictated by the productivity of the labor administration program advocated for policy creation, formulation and implementation (Al Faruque, 2009). In the presence of systemic structures, the sector's employees suffer from unsafe working conditions, persistent violation of human rights and inadequate compliance mechanism (Ahamed, 2011). The RMG sector is beset with numerous disputes between employers and employees conflicting interests.

In addition, experience in the RMG sector demonstrates the fact that the government calls certain tripartite meetings when violence occurs, but no permanent committee arranges those meetings. The roles of those who schedule these meetings are restricted under the country's existing regulatory structure (Ahmed & Nathan, 2016). The current proof of the essence of employers and policy interference in workers demonstrations makes it evident that adhoc measures and approaches for addressing the crisis concentrate solely on restoring stability in the sector by combating the problem of civil unrest and disruption, not on going further into what brings employees into the street and what brings employees into the street protests/first of all, they blockade. However, instead of helping to resolve disputes, the adhoc mechanism merely provides the conditions for the severe appearance and creation of such disputes (Rashid & Rashid, 2015).

The absence of successful plant-level representation of employees leaves employees unable to defend their own interests (Khan, 2015). Employers pursue the preservation of equilibrium and so intervene in a manner that only maintains and proceeds to create industrial harmony. Subsequently, the tactics used to resolve disputes are manipulation and bullying to bypass workers' willingness and interests only to be forced to dispose in some other ways at a certain moments (Khan & Wichterich, 2015). Clearly, the loop, heading not closer to the source of the demands and concerns of the staff, contributes to outcomes and effects that are unjust to the workforce, and diminishes the establishment of industrial harmony. The consequence of such a vicious cycle creates either a rejection of the needs of real workers or a manipulative compromise that is scarcely tolerated by employees and employers (Rahman, 2018).

In order for sustaining the competitiveness of the RMG sector in the global level it requires to ensure timely response to the IBs' needs in terms of making delivery of the RMG products within their expected time along with maintaining the quality of products (Hossain, 2012). Maintaining product quality according the desire of the IBs' will require the industries to make huge investment in employee skill development and capacity building in forecasting the future demand for the products (Alam et al., 2017). On the other hand, capacity building in forecasting the future demand will help the companies to reduce their dependency on the IBs, which also requires the companies to maintain linkages to firms involved in promotion researches overseas (Uddin, 2014). Whatever decisions the industries take regarding their capacity building as well as achieving competitive advantages in the future, all will be of vain if they fail to maintain an amicable IRs (Crisis & Vickers, 2017).

Table 2.8: Literature about Industrial Relations in RMG of Bangladesh

Authors &Year	Article/Journal/Title	Key Findings
(Ahamed 2012)	Can TUs play an effective role in defending workers' rights in the Bangladesh ready-made garment industry?	This paper emphasized on collective bargaining and its ability to strengthen labor conditions in Bangladesh's RMG industry.
(Hossan,Sarker & Afroze 2012)	Recent unrest in the RMG sector of Bangladesh: is this an outcome of poor labour practices?	This research explored the causes for recent unrest in the RMG industry with particular attention to their views on the failure of fair

Authors &Year	Article/Journal/Title	Key Findings
		labor practices.
(Chowdhury et al. 2014)	Prospects and Problems of RMG Industry: A study on Bangladesh	This study showed the effects of dispute resolution in RMG industry in Bangladesh with some measures for the removal of ongoing crisis of RMG sectors.
(Comboh 2014)	Examine Conflicts in Industrial Relations & Collective Bargaining Context and its Impact on Workers & Organization Performance	The study explored the roots of conflicts and their effect on the performance of employers and companies in the context of labor relations and collective bargaining.
(Kurpad 2014)	Made in Bangladesh: challenges to the ready-made garment industry	This paper argued for more productive collective bargaining models and unionism as a solution to the issues facing the RMG industry.
(Mohiuddin 2014)	Labor Management Relations Following the Labor Laws of Ready Made Garments in Bangladesh: The Present Perspective	The analysis of this study addressed labor rights activities in Bangladesh's RMG industry and the degree to which labor regulations are applied in the same sector.
(Siddiqua et al. 2014)	Industrial Relation and Dispute Settlement Procedure in RMG Sector of Bangladesh: A Critical Review	The study presented a summary of the disparity in the RMG sector in Bangladesh between new law and the unique condition of labor relations and the labor dispute resolution mechanism.
(Quddus & Ahsan 2014)	A shop-floor kaizen breakthrough approach to improve working environment and productivity of a sewing floor in RMG industry	This article described that continuous improvement of working environment brings improved productivity in the RMG industries.
(Farhana,Syduzzaman & Munir 2015)	Present status of workers in ready-made garments industries in Bangladesh	This paper described the working environment of workers in the RMG industries in Bangladesh, such as wage level, age group, caste, family life, and working hours.
(Uddin & Tangem 2015)	A Study on the Relationship between Working Environment and Labor Unrest in Ready-Made Garment (RMG) Industry of Bangladesh	The analysis found a connection in Bangladesh between labor unrest and the RMG sector's working climate.

Authors &Year	Article/Journal/Title	Key Findings
(Khan, Dipti, Ferdousi, Hossain, Ferdousi, Sony & Islam 2015)	Occupational Health Hazards Among Workers of Garment Factories in Dhaka City, Bangladesh	The study suggested that more emphasis should be given to the dispute resolution at the working place to improve working environment in the RMG industry of Bangladesh.
(Rubya 2015)	The Ready-Made Garment Industry: An Analysis of Bangladesh's Labor Law Provisions after the Savar Tragedy	The report analyzed the Labor Law Provisions of Bangladesh in the RMG industry after the tragedy of Savar.
(Bakht & Hossain, 2017)	Workplace safety and industrial relations in the readymade garments (RMG) industry in Bangladesh	A detailed evaluation was made by the researchers of the current state of the RMG industry in Bangladesh with regard to IRs, protection at work and regulatory concerns.
(Hossain & Shirazi 2018)	Quality of Work Life among Women Employees Working in RMG Sector of Bangladesh	The paper showed that a good working environment, good relationship with co-workers, respect as an employees, on time fair job evaluation, sense of participation, sense of job security etc. can make a healthy work-life for employees.
(Kabir, Uddin & Akter 2018)	Effect of Some Factors of Organizational Culture In Retaining Employees in Readymade Garments Industries in Bangladesh: An Observation	This study revealed that supportive culture of the RMG increases the satisfaction level of employees and decreases the turnover ratios from the organization and increases the employees' retention.
(Hamja, Maalouf & Hasle, 2019)	The effect of lean on occupational health and safety and productivity in the garment industry	This article identified 18 related studies, indicating a clear positive impact of leaning on efficiency and low positive or mixed results of leaning on job climate such as workplace health and safety.
(Rahim & Islam 2019)	Freedom of association” in the Bangladesh garments industry- a policy schizophrenia in labour regulation	This paper argued for the need to organize an organization in order to ensure a sustained engagement and contribution to the socio-economic and political aspects of IRs in the RMG field in Bangladesh.

Source: Adapted by the Author

2.6 Research Gap

A plethora of previous works has been reviewed to find out the impact of various factors and sub-variables on the IRs process. The researcher has gone through a good number of articles relating to IRs both in the perspectives of Bangladesh and foreign economies. The major factors and sub-factors that have been found to be influencing the IRs in any economy include legislative and institutional measures having expressions in the form of GAs, Labor Act regulating the employment relations, IBs, working environment regulated by again Labor Act, entitlement to organizing association, collective bargaining process, Dispute resolution process, buyers' codes of conduct etc.

There have been a huge number of articles and research done on the issue of IRs giving emphasis mainly to studying the impact of three actors and some main processes like collective bargaining process, dispute resolution process, ignoring the impact of buyers' role until recently. A few number of research works addressing compliance specific impacts on the IRs have been conducted relating the importance of how the other actors involved in the IRs systems are being affected. Over time, there occurs a paradigm shift because of adding new forces to and leaving of old forces from a process, which makes any system difficult to understand, and further researches are needed to be done to explain the new shift in or status of any system. As for the IRs systems in the RMG sector there has occurred to a paradigm shift over time.

Another player or actor like IBs and some unavoidable and untoward incidents or events like Rana Plaza tragedy, violation of human rights, sheer negligence on the part of the employers to ensure a conducive work environment etc. have forced all the stakeholders into making some compelling shift in the IRs in RMG sector. There has been a few sporadic researches done to address individually each of the issues mentioned above. For better planning's sake, and considering the position of our RMG sector in the global market, a research should be done taking into account of all the players including the IBs and major influencing issues like

Rana Plaza tragedy. This current study is all about how the various players are interplaying with each other and major issues in the form of variables and sub variables are influencing each other while determining IRs in RMG sector.

Previous research focused on the IRs and its actors in the RMG sector, it is clear that researchers have given their attention to diverse areas to identify and understand scenario and situations of IRs in RMG of Bangladesh. Past studies explored a number of actors who can contribute to improve the overall IRs in RMG of Bangladesh. However, the roles of specific actors on IRs are not well documented. The present study identified the specific roles of the actors of IRs in RMG industry of Bangladesh.

Moreover, the present study examines the relationships of the roles of each of the actors based on the perceptions of respondents in creating sound IRs situations in the RMG sector of Bangladesh. It also measures the relationships between the new actor IBs and IRs in RMG industry of Bangladesh through the initiatives of TUs, employers and GAs. This study used the principles of strategic choice theory to justify the roles and relationships of the actors with IRs by combining organizing union, strategic HRM, policies, and laws, corporate campaign with workers rights.

2.7 Conclusion

This chapter included a study of relevant information regarding the RMG sector of Bangladesh and its present problems and prospects. This chapter also presented literature reviews regarding the constructs and sub-variables of the study. It reviewed the concept of IRs considered as an outcome. Literatures regarding the definition of actors of IRs are explored and reviewed in this chapter along with their relationships with the IRs. In this chapter, another actor of IRs indentified from the literature. Finally, on the ground of the related literature review, the relationship among the sub-variables and constructs is critically discussed and the gaps of the previous studies have been indentified for the new issues in conducting this study.

CHAPTER THREE

THEORETICAL PERSPECTIVE AND HYPOTHESES DEVELOPMENT

3.1 Introduction

The first part of this chapter draws the theoretical framework to understanding the theories relating to a problem to support the development of research framework. This part presents theories in the related area under study and the justifications for the utilization of strategic choice theory in the present study. After having extensively analyzed and discussed the existing literature regarding theories, this chapter presents the research concept used in this study and then proposes the conceptual research framework based on the existing research model. The focus of the second part of this chapter is the development of the hypotheses of the study.

3.2 Reviewing of Related Theories in the Research Area

Industrial relations is an interdisciplinary field of study of social science, social psychology, sociology, business studies, labor economics, labor law (Blumer, 1947; Byrne, 2002). It is not easy to integrate them into a unified theory because the grounds and frameworks of the actors and their levels of analysis, and their disciplinary tradition disparity (Levinson, 1967). Theoretical pluralism therefore reigns and find out its basis in the numerous theoretical focal points and goals (Müller-Jentsch, 2004).

Various theoretical perspectives used to explain the relationships between the actors and IRs. Industrial relations is related with employment relations among the actors for production (Bellemare, 2000; Tapia et al., 2015). Strategies are tangible measures or regulations for preferring measures in a conflict situation (Nguyen & Yang, 2012). Strategic choice theory uses increasing in both economics and organizational research (Bain, 1968; Chandler, 1962; Kochan, Katz & Capelli, 1984; Porter, 1980). It relates to the design of work rules, the actions of employers and employees, the organization of work, bargaining, and interactions in the workplace and policies governing individual rights at work (Kochan et al., 2018; Kochan,

McKersie & Cappelli, 1983; Purcell & Sisson, 1983). Strategic preference paradigm seeks to describe differences in IRs activities at the corporate decision-making, collective bargaining, and employee relationships stages (Kochan et al., 2002).

In this research, the principle of strategic choice was used to discuss the interpersonal interaction between the main architecture to clarify the IRs mechanism. This theory used in this research clarifies the roles and relationships among the actors of IRs. Another researcher Fox (1974) identified three reference structures in IRs, which hold very different ideas regarding the essence of work, employee relations, and confrontation, outcomes of various ideological and analytical approaches such as unitarism, pluralism, and theories of Marxism. This section deals unitarism theory, scientific management theory, human relations school theory, human resource management practices theory, pluralism theory, labor process theory, stakeholder theory, agency theory, legitimate theory and strategic choice theory, and their limitations shows that why strategic choice theory has been considered as an underlying theory for this study.

3.2.1 Unitarist Theory of Industrial Relations

The Unitarist view suggests that there is little disparity of preferences between an employers and employees. IRs is thus defined by the organization of mutual desires, the result of which is harmonious employees' relations (Geare, Edgar & McAndrew, 2006). This perspective is typical of employee relations management, according to which workplace strategies and procedures will balance employees and employers' interests (Lewin, 2001). This theory begins with a series of beliefs and principles that hold tension in the workplace is not an inherent aspect of employer-employee relations (Cradden, 2011).

This theory argues that conflict in the workplace can occur occasionally between the employers and employees (Cullinane & Dundon, 2014) however, it is assumed that these events are aberrations in a partnership that is intrinsically inclined to cooperation (Ross & Bamber, 2009). This theory claims that organization is established as the primary source of authority within the workers and that all possible sources of authority, such as shop stewards

and TUs, are excluded from the workplace (Fidler, 1981). The approach of this theory neglects causes of conflict (Fox, 1966). It fails to explain the prevalence of conflict within organizations. It does not account for uneven distribution of power among actors in the decision-making process in IRs (Waiganjo, 2012). Therefore, this theory is not suitable for this study.

3.2.2 Scientific Management Theory

The theory of scientific management by Taylor (1974) argues that management's workplace relationship choices starts with the premise that workers are inexperienced in working practices, are likely to escape them wherever possible, and have small self-centered expectations and time horizons (Kemp, 2013). This theory focuses on management practice, which decreases work to its basic elements, thereby minimizing the skills of employees required to undertake tasks (Taneja, Pryor & Toombs, 2011). This argument also suggests impersonally and individually, for all employee problems being assigned to management (Su, 2017). Under these circumstances, the management approach to workplace relations aims to minimize internal conflict over the allocation of corporate authority by ensuring that management retains sufficient understanding of the nature and organization of work and is encouraged to guide employees however it sees fit (Derksen, 2014).

Caldari (2007) criticized this theory because it did not consider the human appreciation. In fact many employers implemented this theory for strict control and punitive measures to drive maximum output. It also causes significant mental and physical strain as well increased the potential for accidents and work stoppage (Huang, Tung, Lo & Chou, 2016). For this reason, this theory is not applicable in the field of IRs.

3.2.3 Human Relations School Theory

The human relations theory discusses the elimination of interpersonal conflict dependent on individuals' desire to attain self-fulfillment in the workplace (Bruce & Nyland, 2011). Employees are regarded as qualitatively different to other resources used in production. This theory emphasizes the management approach to employees-employers relationships, which aims to reduce internal tensions by developing employees' sense of

workplace satisfaction through techniques that involve them in organizing and regulating work (Dubin, 2017). Nevertheless, this theory is criticized because of its failure to consider the impact of larger economic, social and technological factors on the productivity of workers in organization (Korajczyk, 1961). Therefore, such limitation of this theory hinders to apply in this study.

3.2.4 Human Resource Management Practices Theory

Blyton and Turnbull (1992); Guest (1989) argued that the practice of HRM begins with the belief that organizational tensions can be fully resolved by fostering a cooperation-based psychological contract. This theory focuses on the partnerships in the workforce holistically, promoting cooperation between management and workers through creating a unifying atmosphere, effective and omnipresent leadership, and a consistent view of organizational objectives (Kaufman, 2010). This theory states that collective management strategies in the context of organizational teams, performance evaluations, and performance based compensation and employee job contracts are behaviors that are significant in employee and employer relations (Bratton & Gold, 2017). Blyton and Turnbull (1994, p. vii) argued in the preface to their book that the “vocabulary of HRM has surpassed both its conceptual and empirical foundations and that rhetoric has outstripped the reality.” This view of HRM practice theory is not applicable in the context of the present study.

3.2.5 Pluralistic Theory

Pluralists vary from Unitarists in their beliefs and principles that tension in the workforce is unavoidable (Abbott, 2006; Budd & Colvin, 2008; Andati & Otuya, 2019). Employers and employees are two such categories, which owing to the very existence of the factory environment, inevitably perceived as contributing to specific principles and priorities (Heery, 2016). By recognizing the inevitable outcome of conflict in the workplace, those with this perspective tend to see conflict as necessary for a company’s health, as it serves to bring grievances held by workers to the surface (Atzeni, 2010; Denis, Langley & Rouleau, 2007). Recognizing the presence of conflicting forms of influence, most prominently in the context

of shop stewards or TUs, retained by pluralists to provide advantages by requiring companies to cope together with matters related to workplace relations (Zeitlin, 1987). Based on these principles, pluralists typically recognize the legal right of workers to bargain jointly and TUs to work in their behalf in this capacity (Abbott, 2006).

The most prominent theory focused on a pluralist frame of reference is the structure theory of Dunlop (1958), which claims that IRs are better viewed as a subset of the larger social framework (Brown, 2013; Müller-Jentsch, 2004). The theory predicts that work is governed by a wide range of formal and informal rules and regulations covering all aspects of recruitment, holidays, performance, wages, hours and a myriad of other employment details (Baldwin, Cave & Lodge, 2012; Bratton & Gold, 2017). It argues that such laws are what industrial actors seek to decide, that the larger environmental background in which the actors work, and that the actors themselves have an interest in preserving the negotiation and dispute settlement processes (Lamb & Kling, 2003; Meyer, 2010) affects their formulation. The system of IRs conceives an important aspect of this framework as self-adjusting towards equilibrium. To the extent that change in one element has repercussions for the other elements, they held to set a range of processes in motion that invariably restore a sense of order to the system (Ackers, 2005; Cradden, 2011).

The pluralist viewpoint makes no prudence unless it is acknowledged that freedom of agreement is not a fiction that the influence of organized employees is such as to stability the intrinsic benefit of the employers in the employment relationship and that the contract strap between unionized employees and their employers are thus ethically obligatory (Fox, 1974). It is difficult to justify the roles of actors through pluralistic aspects. So, this theory is not suitable in this study.

3.2.6 Labor Process Theory

Labor process theory (LPT) has established a common forum for examining job and work organization (Thompson & Newsome 2004). LPT indicates that the secret to understanding job organization resides not in individual behavior or the complexities of dyadic activity but

in the framework of the larger culture within which it is located (Wardell, Steiger & Meiksins, 1999). Social structure, in addition, is seen as essentially dictated by the dominant ownership relations the essence of power and property rights over economic goods. The characteristic relations of production in capitalist societies arise from the essence of the commodity (Adler, 2007).

Marx conceived the productive forces as including means of production and labor power. The ties of production are formed by the economic control of the productive forces; the most important of such relations is the possession of the means of production by the bourgeoisie under capitalism, whereas the proletariat owns only its labor power. Economic ownership differs from legal ownership in that it concerns the control of productive forces (Bottomore, Harris, Kiernan & Miliband, 1991). The ways the forces and ties of production evolve, and the consequences of this growth, have been the focus of one of the major controversies in Marxist thinking. In Marxist theory, the question of ideology represents a major weakness which Hyman (2013) seems to think is the TUs problem. The TUs are thought to be problematic rather than ideological (Marsden, 1982).

Nevertheless, LPT brings through variation from market relations into capital and labor relations in the place of work, and puts forward that the vivacious of this imbalanced social relationship both limit, condition and drive the organized work. In reality, the employers hired mere capacity of the employees to work; an embodied capability that moves into and out of the place of work, it has to be managed with approval (Smith, 2012). It is postulated here that LPT inadequately supports the field of IRs.

3.2.7 Agency Theory

Agency theory considers the relationship between the actors and the agents (Laiho, 2011). The agency theory can help reduce agency cost, build up managerial ownership structure and increase firm performance. Disputes occur when the actors and agents have their own agenda (Jensen & Meckling, 1976). It is assumed that the agents seldom ensure that the actions carried out are in the best interest of the actors. The theory argues that there is a limitation in the case of monitoring and bonding costs beyond which any additional cost involved in

monitoring and bonding will no longer be beneficial (Tiberti, Stefani& Lombardi, 2016). According to Smith (2011), agency theory does not have impacts on the moral and ethical perceptions about industrial activities. It is postulated here that agency theory inadequately supports the IRs development. Agency theory is appropriate for reducing fairly the agency cost instead of playing a major role of the actors of IRs.

3.2.8 Legitimacy Theory

The legitimacy theory emanates from the social political theory. There exists an implied social contract between an organization and the workplace in which it operates (Campbell, 2000) and that the corporation exists under employment contract (Dowling & Pfeffer, 1975). The term legitimacy is a general perception, which suggests whether the actions of the organizations are right and legal within a given system.

Legitimacy theory appears to give a better understanding of why organizations are involved in work relations development practices under the certain rules and regulations (Deegan, 2002). Dowling and Pfeffer (1975) explain that legitimacy theory plays an important role in developed countries including the USA, Germany, Australia, the UK and Japan since stakeholders of those countries abide by the laws. According to Omran and Ramdhony (2015) legitimacy theory seems to be more suitable for organizations working in developed countries. This study is conducted in Bangladesh, which is a developing country, so legitimate theory is not suitable in this study.

3.2.9 Stakeholder Theory

The concepts of stake and stake holding are found within the IRs literature (Van Buren & Greenwood, 2011). Stakeholders defined as groups or individuals who can affect or are affected by the achievement of the firm's objectives (Van Buren, 2005). IRs, as an academic field has traditionally addressed concerns of worker justice and fair treatment for all workers. Zeitlin (1987) defines the history of IRs as that of the changing relationships between workers, TUs, employers, and GAs. IRs, thus, is not only an academic field, but also a

broader social movement. IRs encompasses a broad range of concerns, including worker representation, worker welfare, wages, organization stakeholder relationships, and conflict was built into the employment system, as both organizations and their employees had different roles and competing interests (Van Buren & Greenwood, 2011).

Lack of power of low-wage workers is common for both workers in industrialized countries (Freeman, Boxall & Haynes, 2007) and developing countries (Armbruster-Sandoval, 2005; Frank, 2005). Deficient credible threats to gain and exercise voice in the employment relationship mean that employers have significant power and control to set the terms of employment (Guerci & Shani, 2014). While it is true that some employers are more liberal than others, most employees would be unwilling to rely solely on the good intentions of their employers. When power and voice are absent, exploitation of a stakeholder group is likely (Phillips, Freeman & Wicks, 2003).

To the neo-classical analysis of stakeholder theory, there are three possible counterarguments (Freeman, Harrison, Wicks, Parmar & De Colle, 2010). The first, underpinned by work in IRs, suggests that not all stakeholders are equally free to consent to or contract with organizations in ways that protect their interests. The second focuses on a libertarian argument of its own, positing that when corporations engage in voluntary then the hand of the government is less likely to restrict business decision making. In the final argument, society at large and stakeholder serve as checks on the power of managers and capital to dictate social and economic arrangements (Freeman & Phillips, 2002). In this regards, this theory is not applicable in this study.

3.2.10 Strategic Choice Theory

In the both economics and organizational research field, the term strategic choice is used increasing regularity (Hyman, 1975; Kochan et al., 2002; Kochan et al., 1984; Pisano, 2017). Strategic choice in IRs is further defined by two considerable matters (Kochan et al., 1983). First, strategic decisions only take effect the actors have control in their actions; so, when

environmental restrictions do not seriously limit the option of alternatives for the actors. Second, strategic decisions within the collection of decisions over which the actors have control are those, which change the position of the actor or its partnership with other actors in the framework of IRs. IRs practices through four key actors who make strategic decisions like employers, TUs, GAs, and the IBs (Whittington, 1988).

It is important to identify and evaluate IRs actors and their positions on three distinct levels, which are defined by the principle of strategic choices (Kochan et al. 1986; Pruitt, 1983; Thurley & Wood, 1983). This theory expresses the notion that job research cannot be limited to the factory floor but rather cover the whole organization as well as the larger societal, economic and legal context that governs IRs in general (Farnham & Pimlott, 1995; Meltz, 1993; Purcell & Sisson, 1983; Streeck, 1987). The theory of strategic choice sets out the following categories for analysis: workplace activities, negotiation and staff management, and the strategic behavior and policy development pursued by each of the four IRs actors (Abbott, 2006; Bellemare, 2000; Heery & Frege, 2006; Kochan et al., 2018). The strategic choice theorists analyze work relationship at the organizational stage, including division and collaboration of labor; administrative level, relating to the distribution of control in the political systems of the production firm or service sector; and social partnerships marked by the struggles of different groups, players such as the community, workplace group, government and buyers (Abbott, 2006; Bellemare, 2000; Kaufman, 2004; Kochan & Cappelli, 1983; Levy & Merry, 1986; Walton, Cutcher-Gershenfeld & McKersie, 2002). Moreover, strategic choice theory includes organizing union, strategic HRM, policies, and laws, corporate campaign with workers rights in the field of IRs (Kochan et al., 1984).

3.3 Underlying Theory

From the 1980s, some Asian countries experienced fast industrialization and then new dimensions of IRs were generated in these countries to which the western organizing frameworks have been useful (Beckert, 1999). The principles for the IRs systems model by

John Dunlop (1958) have the capacity to distinguish the roles of TUs, employers and GAs in the transformations of IRs. The present scenario has added another actor like IBs in the respective model. The strategic choice theory might put forward a more constructive expounding framework for the actors of IRs than John Dunlop's does. The reason behind of its capability to construct this distinction, not just in the entire system, but at various levels of the system (Leggett, 2005).

Strategic choice framework provides a powerful perspective for understanding current IRs within industries (Arthur, 1992). The strengths of a strategic choice theory are its flexibility and rigor, but also elucidate its weaknesses, which lies in its excessive simplification, and causal incompleteness (Child, 1972). A strategic choice theory is particularly suited to the study of interactive relations. A strategic choice theory begins with purposive, internationalist, rational explanations of behavior and adds the components of actor interaction (Jewer & McKay, 2012). The actors' choices reflect not only their preferences and the constraints they confront but also the existence of other actors making choice (Kochan et al. 1984).

In particular, it emphasizes the choice of business strategy by the management as a critical factor in determining the outcome of IRs. Lewin (1987) concluded from his study of empirical studies on the strategic choice model of IRs, shows that the form of IRs policies and practices of position is closely linked to the business policy choices taken by the actors of IRs. Therefore, strategic choice theory is connected both the mechanism and substance of decision formation to the target attainment of all the actors of IRs (Kochan et al., 1983; Kochan et al., 1984; Kochan, Katz & McKersie, 1986; Kochan et al., 2002; Kochan et al., 2018). The debate is that specifying the actors' strategic choices will assist to complete the systems framework and to make clear numerous inconsistencies mentioned earlier. Table 3.1 demonstrates the place and stage where strategic choice construction occurs.

Table 3.1: Industrial Relations Strategy Matrix

Decision level	Employers	Unions	Government
I. Macro or global level for the key institutions	The strategic role of human resources; policies on unions; investments; plant location, new technology; and outsourcing	Political roles (e. g. , relations with political parties and other interest groups); union organizing (e. g. , neutrality and corporate campaigns); public policy objectives (e. g., labor law reform); and economic policies (e.g., full employment)	Macro economic and social policies; industrial policy (protection vs. free trade)
II. Employment relationship and industrial relations system	Personnel policies and negotiations and strategies	Collective bargaining policies and negotiations strategies (employment vs. income)	Labor and employment standards law, direct involvement via incomes policies or dispute settlement
III. Workplace: individuals and groups	Contractual or bureaucratic; and individual employee/workgroup participation	Policies on employee participation; introduction of new technology, work organization design	Regulations of worker rights and/or employee participation

Source: Kochan, McKersie & Cappelli, 1984, p. 23)

In the table 3.1, the actors of IRs are presenting in the columns of the matrix and rows are presenting the strategic decisions of the actors. The level of strategic decisions is based on the macro or global, employment relationship and IRs system, and workplace individuals or groups. At the macro or global level, the employers have taken the strategic roles of HR; policies on TUs and outsourcing where the TUs play political roles, have the rights of union organizing, and have the public objectives and economic policies. In the same level the government uses strategic decisions from the view point of macro economic, social, and industrial policies (Kochan et al., 1984).

In the level of IRs system and employment relationships, the employers use strategic decisions regarding personnel policies and negotiations where the TUs choice collective bargaining policies and negotiations and government formulates laws of labor and employment and the strategic policies for dispute settlement. Strategic choices in the bottom row are associated with employees as individuals or work groups and their relations with the immediate work environment. This level provides the employers the scope of contractual or bureaucratic; and individual employee/workgroup participation whereas the TUs use strategic policies on employee participation; introduction of new technology and work organization design. Finally, in this level the government strategically regulates workers rights and/or employee participation. The IB as the actor of IRs uses the strategic decisions regarding the worker rights and corporate campaigns by providing their CoC.

The objectives for this study are to measure the relationships of the roles of the actors involved in IRs in RMG industry of Bangladesh. As this theory of strategic choice is plausible in addressing the research questions of this study, this theory is more relevant than the other theories in IRs within the RMG industry in the sense of a developing country such as Bangladesh.

Table 3.2: Summary of the Key Literature on Industrial Relations Theories

Authors	Proposed Theory	Findings/Key argument
(Leggett 2005)	Strategic choice	This thesis focused on the utility of the strategic choice paradigm for describing the transitions of IRs.
(Van Buren & Greenwood 2011)	Stakeholder	The study found that scholarship in labor, IRs will benefit from the convergence of language, and scholarship of stakeholders, as the definition of stakeholders has acquired popularity and credibility among academics in a number of fields.
(Harcourt 1993)	Social systems	The study found that social systems theory offers the most promise for IRs theory development, because of its innovations in strategic choice within the constraints imposed by institutions.

Authors	Proposed Theory	Findings/Key argument
(Bellemare 2000)	Strategic choice & French Regulation	The study proposed the theoretical framework on base an overview of the actors in the industrial system.
(Kaufman 2010)	Labor Market	The author has identified the core principle of the theoretical and methodological basis for the field of IRs.
(Tapia et al. 2015)	IRs meta-theories	The study proposed new theories and analysis directions, which would broaden the number of individuals or organizations that form employment relationships and incorporate social roles beyond the employment relationship as the foundation for mobilizing mutual behavior and speech.
(Anyim, Ikemefuna & Ekwoaba 2012)	Dunlopian theory	The paper made a critique of the Dunlop model and anchored with the impact and relevance of the model to the practice of IRs.
(Kochan 1984)	Strategic choice	The author argued that the role that strategic choice could play in this more complex paradigm could be broadened and discussed in IRs.
(Turnbull, Blyton, Mcgurk & Lucio 2000)	Strategic choice	The study highlighted the strategic choice perspective of IRs, which focuses on confrontation between capital and labor and allows comprehending organizational change and IRs.
(Fells 1989)	Strategic choice	The study argued that strategic choice provides a means of relating the actors of IRs actions back to the central focus of the employment relationship.
(Child 1972)	Strategic choice	The study found that in any adequate theory of organizational structure the role of strategic choice is a necessary element.
(Sekiguchi 2005)	Strategic choice	This study indicated that the model of strategic choice, originally developed might also be extended to IRs.
(Abbott 2006)	Unitarism, pluralism, Marxism	This paper presented and aligned a range of contemporary theories in the real work world circumstances.
(Shirom 1985)	Systems theory	This article explained that the components of the labor relations structure are identified and analyzed based on relational systems theory and jargon, to refer to the partnership between a union and management in the workplace.

Source: Adapted by the Author

3.4 Existing Research Model

To explain the industrial interaction between three groups: employers, TUs and the GAs, the Dunlop model was developed in 1958 by John Dunlop (Hitt & Tyler, 1991). This model was useful explanatory device for stable IRs (Kochan et al., 1984), but in the 1960s and 1970s, it was observed that IRs become unstable. The unstable situation was arisen because of the conflicting nature of collective bargaining and the functions of CBA, which took, front the challenge of Dunlop's beliefs regarding the actors in the IRs system (Lewin & Feuille, 1983). According to Bain and Clegg (1974) cited in Chidi and Okpala (2012), a traditional approach to IRs has been to regard it as the study of the rules governing employment, and the ways in which the rules are changed, interpreted and administered. In modern time, there are some crucial changes in IRs theories. The following existing model represents the IRs.

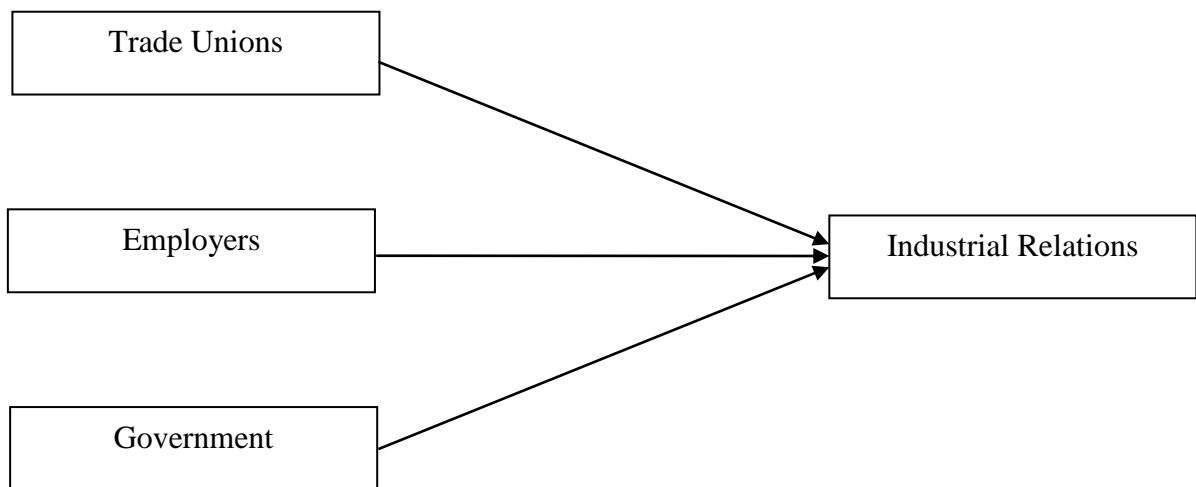

Figure 3.1: Existing Research Model

Source: (Original by Dunlop 1958; hired by Edward, 2009; supported by Ullah, 2016)

The above model represents the most common structure of employment relations, which was invented by John Dunlop in 1958. This model is hired by Edward (2009) and supported by Ullah (2016). The figure shows that the three actors of IRs, TUs, employers, and government have the direct relations in maintaining IRs in an organization. This model will guide to measure the relationships between the actors and IRs in the RMG industry of Bangladesh.

3.5 Conceptual Framework

The Industrial relations model provided by John Dunlop in which three actors are identified to some extent the model is still valid. Meanwhile, strategic-minded employers get the better off TUs and a strategic minded government legislated to restrain collective bargaining to be a focus for investment by IBs (Stein, 1999). The literature reviewed earlier and the review of the underlying theories has justified the sufficient applicability of the theories under consideration to IRs in research into the RMG industry of Bangladesh. As discussed in the above sections of this chapter, strategic choice framework provides a powerful perspective for understanding current IRs within industries. A central challenge for IRs study is to build models and theories to describe this diversity.

In previous studies, researchers have argued that this complexity can better be interpreted using a strategic decision system. This framework differs from the traditional framework of the system of IRs in that it underlines the choices available to actors within a given set of relationships. In particular, it emphasizes the choice of business strategy by the management as a critical factor in determining the outcomes of IRs. During the 1980s, the framework for strategic choice was based on previous understandings of changing IRs world. Kochan et al. (1986) strongly argued that the system had moved away from the arrangement of IRs established by the respective country's legislation.

Do (2011) and Yin (2003) argued that the strategic choice paradigm is helpful in defining, illustrating, and evaluating the shifts in IRs frameworks. Therefore, this theory is suitable for examining the relationships among different actors of the IRs in RMG industry of Bangladesh. A brief application to developing countries' IRs through Verma et al. (1995) indicated that the strategic choice approach is a useful analytical and diagnostic tool.

Literatures show that the RMG sector's future stability depends on IBs satisfaction and meeting actors' demands. In the RMG sector in Bangladesh workers' rights are grossly

violated as a result IBs put pressure on RMG owners to ensure compliance with a CoC before placing any import order particularly after the Rana Plaza disaster. Compliance issues are fundamental to the workers' interests but at the same time are costly to implement (Ahmed, 2011; Berik & Rodgers, 2009; Hossain & Arafin, 2015).

As it mentioned in the chapter four of the present research, the field study has conducted with the in-depth interview with 16 participants relating to the RMG industry. The participants during the interview addressed that buyers' compliance of RMG factories is a basic and key requirement for RMG, which ensure labor rights based on IBs' CoC. The literatures and the qualitative field study highlighted another actor of IRs, which incorporate existing model of IR provided by John Dunlop. Accordingly, the conceptual research framework mentioned in figure 3.2 to be used to develop the hypotheses and survey questionnaire for the quantitative part of this study.

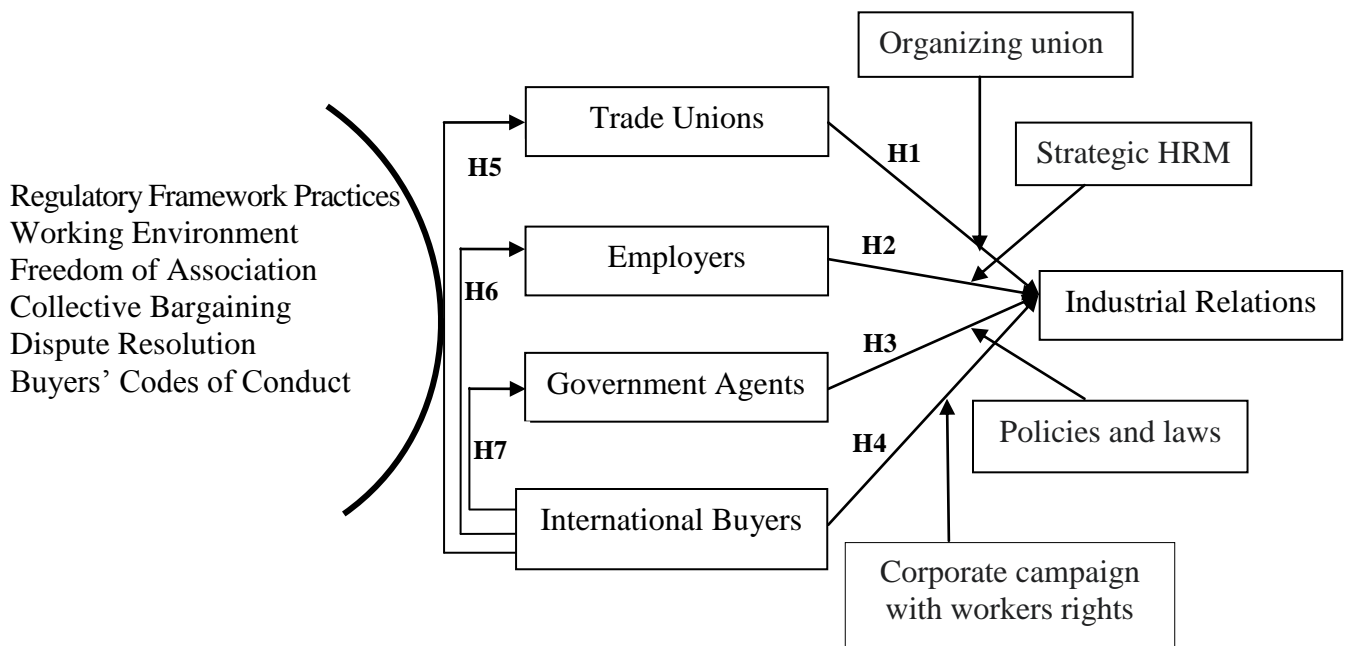

(Strategic choice Theory: Organizing union, strategic HRM, policies and laws, corporate campaign with workers rights)

Figure 3.2: Conceptual Research Framework

3.6 Hypotheses Development

This section attempts to justify and draw a number of research hypotheses on the basis of the theories, literature and field study. Based on the literature and in-depth field study, a number of possible relations of the actors have been selected that have impacts on the IRs in RMG industry of Bangladesh. The actors under examination include TUs, employers, GAs and IBs. Seven hypotheses are then generated accordingly.

3.6.1 Trade Unions and Industrial Relations

An employee individually is weak in the bargaining regarding his interest and rights but if he can bargain collectively with his co-workers then can protect and advance interests (Ahammad, Shanta, Hossain & Naim, 2017). This collective platform of the employees is TUs. TUs provide the individual employees a collective place in the organization where the group of employees gets the capability to represent and safeguard their interests. Individually, the employee unable to bargain for his interest and rights because either fears for dismissal or for facing harassment (Sinha, Sinha & Shekhar, 2017).

The trade unions, the organized platform of the employees through the leadership bargain with the owners and the management and negotiate regarding the fulfillment of the terms and conditions of their contracts done with the employers during their appointment. The TUs bargain and negotiate regarding the wages, work rules, complaint procedures, rules governing hiring, firing and promotion of workers, benefits, workplace safety and policies (Shrestha, 2012). Flanders (1975) mentioned that TUs is an integral part of IRs, which is formed and carried by the combination of employees primarily for regulating the relations between employees and employers.

Kohl (2009) discussed in his study regarding the TUs and stated TUs are voluntary association of employees formed for the purpose of protecting and advancing the members interest and rights. Apart from this, TUs provide their focus on the maintenance or improving

the conditions of the employment of their members (Monappa, 2001). The previous literatures prove that TUs have a significant effect on IRs (Shrestha, 2012). Previous evidence showed that the advocacy of TUs has improved a number of working conditions of many employees. Sometimes, in the IRs arena TUs assist the employers and the management to formulate policies and rules for the welfare of the employees to create a peaceful and productive work environment (Emmenegger, Graf & Strebel, 2020). Particularly, in the BLA 2006 the specific laws are formulated for the protection and functions of TUs in Bangladesh (Al Faruque, 2009).

Previous studies by Freeman (1992), Lincoln and Boothe (1993) showed that TUs by adopting new approaches to collective bargaining that creates greater responsibility in them and such creates more cooperative and productive workplaces in the industries. Eaton and Voos (1992); Black and Lynch (1998) put the evidence regarding the benefits of having TUs in the organization where they mentioned that if unions are actively involved then sound IRs can be ensured. Moreover, many studies have reported that IRs is more tranquil when there is an increased level of union loyalty (Sherer & Morishima 1989).

Gallagher and Clark (1989); Barling, Fullagar and Kelloway (1992) found in their studies that TUs as an actor of IRs can develop more conducive relationships and secure improved performance outcomes in the workplace. Deery et al. (1994) found, for instance, that TUs had positive effects on IRs. Therefore, there is a widespread research authentication to point out that the existence of IRs is significantly dependent on the nature of the TUs and its relationship (Barling et al. 1992). However, in this study the following hypothesis has been drawn for testing.

H1: There is a positive relationship between the roles of trade unions and industrial relations in RMG industry of Bangladesh.

3.6.2 Employers and Industrial Relations

Employers are the actors or parties who hire the employees for performing in manufacturing and services (Ackers & Wilkinson, 2003). The employers define the terms and conditions of the employment, and legally responsible for working practices in the organization (Noe et al., 2015). Harmonious relationship is essential for both employers and employees to uphold the wellbeing of the actors of IRs (Gospel, 1983). The employers of the organization are responsible for arranging and ensuring satisfactory work environment for the employees (Backhaus et al., 2002). Siddiqua, et al. (2014) showed that employers and their roles have significant effect in creating sound IRs in the organization.

According to the study by McCleary et al. (2017), the employers bargain regarding the issues of terms and conditions of employment with the employee representatives. They pay their attention to GAs concerning rules, regulations, and conflict resolution for operating their organization. Moreover, the employers deal with the IBs for their products sales and shipment. For creating a sound IRs employers become conscious of safety requirements to ensure that everyone in the industry is working in a good workplace (Fernando, Zailani & Janbi, 2008). The employers' commitment and their work related behavior towards the actors of IRs has been identified as a crucial in the industry (Bakhshi, Kumar & Rani, 2009).

The industry that creates and maintains good quality employers and employees relationships will benefit from higher levels of the employee motivation, commitment, and job satisfaction, which is in turn impacted positively on the IRs (Leung, Chong, Ng & Cheung, 2004). Employers provide legislative framework to promote and encourage collective bargaining at workplace thus the primary aim of the act is to promote sound IRs (Faridah, Hashim, Salimin & Mahmood, 2010). In order to maintain good relationship in the industry, the main functions of employers should avoid any dispute with workers or settle it as early as possible to ensure industrial peace and higher productivity (Rubya, 2015). In the industry employers enable harmonious relationships by assurance the interest of the all actors and such situation create a sound IRs (Foster & Rasmussen, 2010). Accordingly, this study proposes the following hypothesis H2.

H2: There is a positive relationship between the roles of employers and industrial relations in RMG industry of Bangladesh.

3.6.3 Government Agents and Industrial Relations

Along with the employers and TUs there is a third actor who has the direct relations with the IRs is the government (Marshall, 1992). For oversee the industrial issues government has many agencies, each of which has its own discrete purpose and function (Katz, Kochan & Gobeille, 1983). The agents of the government work as an open system rather than a single or uniform actor (Hyman, 2015). In the IRs, the GAs captures the interactions of all the institutions that carry out the will of the government (Hyman, 2008). Omotayo & Ome-Egeonu (2015) described that GAs provides socio-legal environment within the industrial activities. The GAs is the protector of the labor rights (Al Faruque, 2009) by promoting the formation of governance throughout the whole workplace issues. According to Dundon & Rollinson (2004) as the protector in the IRs and social justice, the GAs are responsible to settle the relations based fundamental human rights so that the majority of employees are able to share the social progress and economic development outcomes to achieve the industrial balance.

Government agent as an institution and as a unit of social analysis has undergone different conceptions (Okaka, 2005). The GAs thus became a necessity, and interventionist machinery for guiding and regulating the passions, emotions, behaviors of individuals, and standardizing human relationships (Ravenswood & Kaine, 2015). It is incontestable that GAs performs specific functions in any industrial system (Omotayo & Ome-Egeonu, 2015). Government makes legislations in the area of IRs and GAs mediates conflicts between the different actors in an industrial dispute by way of arbitration and conciliation. William and Adam-Smith (2006) described that GAs as the regulator and provider of socio-legal environment within which industrial activities take place. It is thus the mediator in industrial disputes involving employer or his agents and employee or his agents (TUs).

According to Richard Hyman (2007), the study of IRs focuses on the rules, which govern the employment relationship, the institutions involved in this process and the power dynamics among the main agents of regulation. GAs establishes and administers policies, programs, and

exercises executive, political, and sovereign powers through state customs, institutions, and laws (Sarooshi, 2003). GAs plays a central role in the development of IRs systems by implementing and systematizing structural reform through a collection of specific public capacities, narrating and analyzing of the crisis in IRs, solving the joint action problems of employers and TUs, and predicting and establishing partnerships among industrial actors though it is necessary to not neglect the explicit repressive force of the government (Hayter & Lee, 2018).

Industrial relations in RMG of Bangladesh are now leaning by the legislation of the government as such the GAs has become one of the most influential actors in IRs in the sector (Al Faruque, 2009). Over the past quarter-century, GAs' involvement has inclined to IRs in RMG of Bangladesh by providing some basic policy support such as back-to-back letters of credit, the duty drawback scheme, bonded warehouse facility, and cash incentives (Afrin, 2014). GAs influence wages, workplace peace, health, and safety, discipline and dispute, and look for to get better the well-being of employees in employment (Ansary & Barua, 2015). With the development concept growth, the GAs will build up their method to protect workplace well being in the industrial field. Hence, the prediction is in the following:

H3: There is a positive relationship between the roles of government agents and industrial relations in RMG industry of Bangladesh.

3.6.4 International Buyers and Industrial Relations

The complexity of buyer-industry relations and the importance of mutual adaptations mean that the analysis of relationships must be the overall relationship among the actors of IRs (Ford, 1980). There are extensive opinions that buyers play a key role in global business (Gereffi, 1999). It is still being debated influence of powers of buyers and suppliers on each other particularly in developing countries (Cajal-Grossi, Macchiavello & Noguera, 2019). In reality, suppliers face increasingly powerful buyers who influence the relations among them (Hossain et al., 2019). Buyers are taken as the elementary factor in industrial field (Hossain & Arefin, 2015). Industries pay maximum attention to the buyers and emphasized on their requirements and demands (Antras, 2015). The role played by buyers adopting radically

different in the field of the industry (Taylor & Wiggins, 1997). The empirical evidence on the relationship between the buyers and the industry would improve our understanding of the roles of buyers in the IRs (Goldberg & Pavcnik, 2007; Lederman et al., 2010).

As production becomes increasingly globalized, working conditions and labor rights in global buyers have entered the spotlight and come under increased scrutiny. In the absence of effective government regulation and a global regulatory framework, IBs give their attention towards the working conditions in most developing countries for having a sound IRs (Oka, 2010). The IB is viewed as the context of network, since in its product value originates in the up-stream network of industry (Ellegaard, Johansen & Drejer, 2003). Jiang (2009) has found a statistically significant link between the nature of relationships between IBs and IRs based on survey data from China's RMG industry. Jiang showed that the relationships between the IBs and the IRs characterized by open and two-way dialogue are positively related to each other. Oka (2010) stated that IBs create constructive pressure to improve workplace environment by complying national and international laws.

In order to export RMG it is not only the quality parameters but also the working environment, in where the RMG products produced. The CoC must be stretched towards achieving the objectives of social compliance issues (Das, 2008). In previous, most qualitative and descriptive literature has studied by Appelbaum and Gereffi (1994), Bernard et al., (2018b), Cajal-Grossi et al., (2019), Eaton, Jinkins, Tybout and Xu (2016), Gereffi (1999), Heise (2018), Monarch (2018), Monarch and Schmid-Eisenlohr, (2017) argued and showed that IBs as a crucial player of RMG industry create more pressure than other actors for a healthy, positive, collaborative, creative work environment because it builds positive employee relations. Particularly, in the RMG industry of Bangladesh, the audit of IBs regarding the workplace safety and health invoke the employers of the industries to improve workplace. At present in the RMG of Bangladesh, the employers are strictly following CoC of the IBs to impress them and keep their orders (Hasan & Arafin, 2015). As a result, the following hypothesis stands out to be as follows:

H4: There is a positive relationship between the roles of international buyers and industrial relations in RMG industry of Bangladesh.

3.6.5 Mediating effects of the roles by TUs, employers and GAs to explain the relationships between IBs and IRs in RMG industry of Bangladesh.

The previous literature indicates that IBs influence RMG industries to improve workplace environments of its factories. Most RMG industries in Bangladesh pay their attention to workplace environment standards and laws. Consequently, many IBs now demands from the industries regarding the compliance according to their own CoC. In order to export readymade garments, it is not only the quality parameters that are important towards acceptance of the product as per the intended end use, but also the working environment, in which the garments are to be produced, is equally important so that sweatshop concept is totally taken care of and the CoC of the IBs must be stretched (Das, 2008; Haider, 2007). To ensure social welfare, buyers now a day imposes several conditions related to workers wellbeing and safety (Hossain & Arefin, 2015). In the field study, the participants argued that IBs plays an important role to improve the IRs of RMG industries in Bangladesh by creating intensive pressures to the employers in comply with labor laws and provide RMG workers a decent workplace.

The actors are engaged into the IRs mainly to create conditions under the law to take measure to promote employment to help unemployed people, abolish the outdated polices and intervenes into the large scale of layoffs. Moreover, the actors benefits from IRs in that a safe working environment promotes employees and employers satisfaction through the cooperation towards IBs, which in turn helps, maintain high employment rates. The IBs plays a major role in regulating, controlling and intervene the IRs through their CoC and the support to the actors. Moreover, the actors establish the working hour, make sure the minimum wage standard, and determine the working conditions, labor protection, social insurance, and welfare system, which are the CoC prescribed by the IBs in the RMG industry of Bangladesh.

The Alliance is a five-year commitment of the North American buyers of RMG from Bangladesh who has the initiatives aimed at improving the safety of RMG factories in

Bangladesh (Ahlquist & Mosley, 2020). The Alliance has created an unrestricted opportunity for RMG companies and IBs to come together and present a concrete solution to a security problem that will be largely transparent, efficient, measurable and verifiable (Salminen, 2018). Every member of the Alliance and their factories are responsible for maintain and strengthen a safe working environment throughout Bangladesh through the development of factories, training of workers and managers, labor empowerment, and building renovations and also ensuring effective building and fire safety (Donaghey & Reinecke, 2018).

Besides, Accord is an independent and legally binding agreement between IBs of Europe and TUs that works to build a secure and strong Bangladeshi RMG industry (Khan & Wichterich, 2015). As stated earlier, the Rana Plaza factory collapsed on April 24, 2013, killing a total of 1132 people and seriously injuring more than two and half thousands (Kabeer, Haq & Sulaiman, 2019). In the years before the Rana Plaza building collapsed, there were severe fires in many factories in Bangladesh. In this regards, the Accord is designed to create a work environment where no worker is at risk of fire, building collapse or any other accident that can be prevented through moderate health and safety measures (Ahlquist & Mosley, 2020). Multi-actors like employers, TUs, and GAs interactions with the IBs are expected within the RMG industry. The IBs with the partnership with the TUs, employers, and government ensures that their work contributes to the sustainable and positive development of RMG sector (Newhall, 2017). Such partnership ensures sound IRs in RMG industry of Bangladesh (Akhter, Rutherford, Kumkum, Bromwich, Anwar, Rahman & Chu, 2017). Therefore, the following hypotheses are drawn:

H5: There is a positive mediating effect of the roles by TUs to explain the relationships between IBs and IRs in RMG industry of Bangladesh.

H6: There is a positive mediating effect of the roles by employers to explain the relationships between IBs and IRs in RMG industry of Bangladesh.

H7: There is a positive mediating effect of the roles by government agents to explain the relationships between IBs and IRs in RMG industry of Bangladesh.

3.7 Conclusion

This chapter discusses the development of an integrated theoretical framework to explain actors and its relationship with the IRs, and the formulation of testable hypotheses to examine the hypothesized relationships. Explicitly, this research acknowledges TUs, employers, GAs and IBs as the actors of IRs in the RMG industry of Bangladesh. Then, it extends the explanatory determinants of strategic choice theoretical approach to offer a comprehensive understanding of IRs in RMG industry of Bangladesh. The IRs of RMG industry of Bangladesh depends on the actors of TUs, employers, GAs and IBs.

CHAPTER FOUR RESEARCH METHODOLOGY

4.1 Introduction

This chapter explains the approaches and methods used in this analysis to examine the research questions and objectives mentioned in the first chapter. Mixed-method that incorporates both qualitative and quantitative approaches is used in this study. The first section describes the research paradigm, methods and process. The second section shows the techniques of sample selection, questionnaire design, and data collection procedure and processing of qualitative data. The final section presents the techniques of sample selection; measurement instrument, questionnaire design and development, and data collection procedure for quantitative field study. This chapter concludes with an overview of the using partial least square (PLS) based structural equation modeling (SEM).

4.2 Research Paradigm

A paradigm is a basic concept and theoretical framework, including expectations about knowing and observing the nature of the universe (Rehman & Alharthi, 2016). The research paradigm is the framework of analysis (Creswell & Creswell, 2017) which illustrates how the study is structured, how data is gathered, and how the results are interpreted (Nuruzzaman, 2013). It is defined by the collection of universal views and agreements held by scientists about how to interpret and solve problems. Morgan (2007) explained a paradigm as the set of beliefs and practices driving a region that can be used to define the beliefs of researchers. The research paradigms are positivism, constructivism/interpretation, pragmatism, subjectivism and critical, which were explored to create a methodological basis study (Nuruzzaman, 2013). The paradigms are also known as ontological, epistemological, theoretical perspective, methodological and methods under certain assumptions (Burrell & Morgan, 1979; Guba & Lincoln, 1994). The following table 4.1 shows the research paradigms in research works.

Table 4.1: Research Paradigm

Paradigm	Ontology What is reality?	Epistemology How can I know reality?	Theoretical Perspective Which approach do you use to know something?	Methodology How do you go about finding out?	Methods What techniques do you use to find out?
Positivism	There is a single reality or truth (more realists).	Reality can be measured and hence the focus is on reliable and valid tools to obtain that.	Positivism Post-positivism	Experimental research Survey research	Usually quantitative, could include: Sampling Measurement and scaling Statistical analysis Questionnaire, Focus group interview
Constructivist/ Interpretive	There is no single truth. Reality is created by individuals in groups (less realist)	Therefore, reality needs to be interpreted. It is used to discover the underlying meaning of events and activities.	Interpretivism (reality needs to be interpreted) <ul style="list-style-type: none"> • Phenomenology • Symbolic interactionism • Hermeneutics Critical inquiry Feminism	Ethnography Grounded Theory Phenomological research Heuristics inquiry Action Research Discourse Analysis Feminist Standpoint research	Usually qualitative, could include: Qualitative interview Observation Participant Non participant Case study Life history Narrative Theme identification
Pragmatism	Reality is constantly renegotiated, debated, interpreted in lights of its usefulness in new unpredictable situations.	The best method is one that solves problems. Finding out is the means, change in the underlying aim.	Deweyan pragmatism Research through design	Both inductive and deductive; both quantitative and qualitative (mixed method)	Combination of any of the above and more, such as data mining expert review, usability testing, physical prototype
Subjectivism	Reality is what we perceive to be real.	All knowledge is purely a matter of perspective.	Postmodernism Structuralism Post- structuralism	Discourse theory Archaeology Genealogy Deconstruction etc.	Auto ethnography Semiotics Literary analysis Pastiche Intersexuality etc.
Critical	Realities are socially constructed entities that are under constant internal influence.	Reality and knowledge is both socially constructed and influenced by power relations.	Marxism Queer theory feminism	Critical discourse analysis, critical ethnography action research ideology critique	Ideological review Civil actions Open-ended interview, Focus groups, open-ended questionnaire, Open-ended observations, and journals.

Sources: Adapted from Crotty (1998); Scotland (2012); Rehman and Alharthi (2016); Geelan (2015); Shaw, Connelly and Zecevic, (2010); Doyle (2009); Creswell (2003); Nelson (2006)

The above table 4.1 describes that ontological premises include what constitutes reality. In this paradigm the researchers need to take a stance about how they understand how things truly are and how they really function (Crotty, 1998). Epistemological concepts include how to construct obtain and convey information, in other words what it takes to learn (Guba & Lincoln, 1994). A theoretical viewpoint is a collection of real-life observations that shape the questions we ask and the answers we get as result (Huang, Wu & Wang, 2019). Methodology is the technique or action plan that underlies the use and use of different approaches that are concerned with the collection and analysis of data, when, where and how (Crotty, 1998). The basic techniques and procedures used for the processing and analysis of data are methods (Crotty, 1998).

Positivism believes reality is independent of human beings. It is not controlled by our senses and is regulated by rules that are eternal (Lach, 2014). Positivists view their approach as neutral in value; hence, the information produced is neutral in value. Interpreters and analytical thinkers have strongly criticized the positivist model (Rehman & Alharthi, 2016). One of the most frequent criticisms is that empirical techniques, while ideal for the study of natural phenomena, fell short when used to research individuals and social phenomena (Gall, Gall & Borg, 2003; Grix, 2004; Richards, 2003).

Interpretive approaches provide context and interpretation of behavior, describe behavior from the perspective of the individual, and do not overpower the participants (Scotland, 2012). Sources include open-ended interviews, focus groups, open-ended questionnaires; open-ended insights, process speak aloud, and role-play. Such approaches produce qualitative results, in general. Research is the understanding of the researchers; thus, researchers should make their agenda and value system clear from the start.

Pragmatism is a theory that attempts to explore truth in problem solving and the effects of objects and actions in the actual nature of fact (Cherryholmes, 1992). The initial focus on practicality and actual problems allows pragmatism to refuse many of the strict requirements

for assertions of knowledge presented by other paradigms; pragmatists are concerned with universal facts, their utility and fulfillment, the effectiveness with which they function (Shaw et al., 2010). The unique statement that truth is associated with problem solving provides a foundation for using pragmatism as a model for itself (Camerino, Castañer & Anguera, 2014). Analysis using mixed methods enables findings from both quantitative and qualitative data collection techniques to be combined into convergent hypotheses for a research sample (Creswell & Plano, 2007). The integration of qualitative and quantitative study lines in a pragmatist model makes for a more systematic approach to a research problem focused on the nature and history of the field of physiotherapy (Shaw et al., 2010). As a technique for research with mixed approaches, pragmatism has gained significant support (Feilzer, 2010; Johnson & Onwuegbuzie, 2004; Maxcy, 2003; Morgan, 2007).

This study focused on IRs through the roles of its actors in RMG industry of Bangladesh. This study aimed at identifying the actors, which are playing their roles in creating and enabling a sound IRs. The problem of the study specified the questions for conducting the present study to attain the objectives. One of the aims of this research is to assess the relationships between the positions of different actors and IRs in the RMG industry. By incorporating the literature and the opinions of actors employed in IRs in Bangladesh's RMG, the conceptual model was developed and validated. Finally, the study's goals required the conceptual model to be tested to identify the significance of the roles of actors and IRs in Bangladesh's RMG sector.

The mixed-method approach of this study will help resolve the goals of the current study of two ways: (i) the qualitative component will resolve research questions about how TUs, employers, GAs and IBs are related to the IRs; and (ii) the quantitative part can explain the relationships between the roles of the actors and the state of IRs. The method selected for this analysis is a mixed-method approach that incorporates qualitative and quantitative approaches. The pragmatism model is selected in this analysis as the suitable model to explain the use of mixed-method research (Howe 1988; Tashakkorri & Teddlie 1998). The pragmatist view can combine subjective and rational views epistemologically, and can use both inductive and deductive reasoning to better explain the facts and justify the results of this analysis.

4.3 Research Methods

The elements of mixed methods, both qualitative and quantitative are adopted by this study. Mixed methods described as an analysis in which the researcher collects and analyzes data, integrates the findings and uses both qualitative and quantitative approaches to draw inferences in a single study (Tashakkori & Creswell, 2007). In response to numerous research questions, Creswell and Plano (2007) argues that mixed methods research helps to address research questions that cannot be answered by quantitative or qualitative methods alone. Moreover, offers a wider repertoire of resources to achieve a study's goals and objectives. The key rationales or advantages suggested for conducting an analysis using mixed methods are triangulation, which helps a research to be more accurate by validating qualitative and quantitative results (Greene, Caracelli & Graham, 1989).

Bryman (2006) suggests that this is close to flat quantitative proof that places meat on the bones. Development and evaluating hypotheses, a qualitative step of an analysis can be conducted to establish theories, which will be checked in a quantitative follow-up process. A qualitative study may generate items for inclusion in a questionnaire to be used during the quantitative phase of a study to develop instruments and tests. To have diverse viewpoints and beliefs, qualitative observations must be balanced by quantitative data (Johnson, Onwuegbuzie & Turner, 2007).

In addition, Creswell (2009) argued that the use of the mixed method approach in study would increase the ability of data collection and improve the accuracy of test measurements. This is because, whether qualitative or quantitative, each approach has its own limitations. In particular, an approach applied by a single method will eventually yield distorted and minimal results (Greene et al., 1989). Accordingly, their mutual and conflicting shortcomings would be compensated for by the combination of qualitative and quantitative approaches. The quantitative method, for instance, provides a solid basis for the theoretical context, while the qualitative method gives realistic insights into specific problems (Greene et al., 1989).The following figure 4.1 shows the methods for the present study.

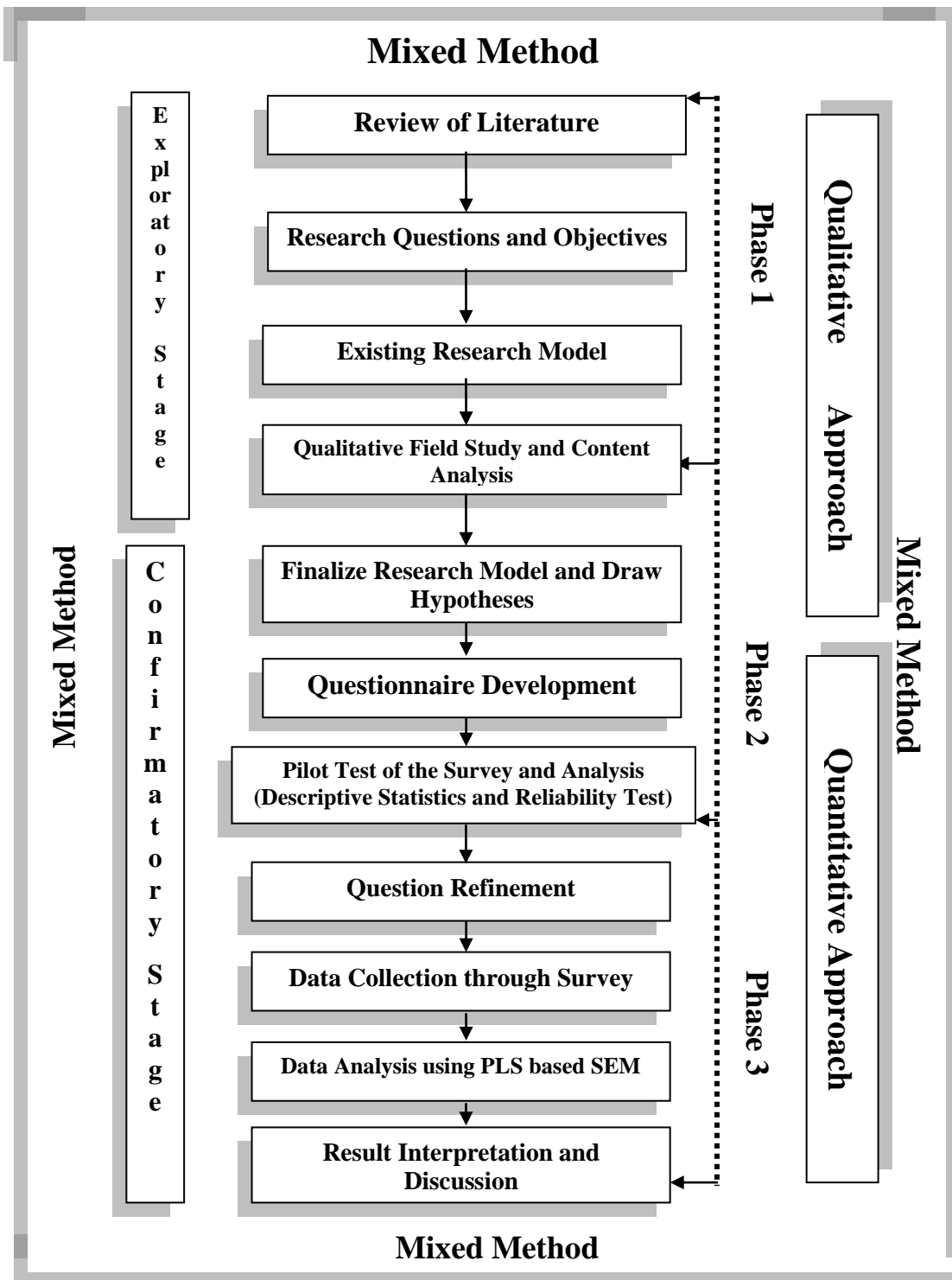

Figure 4.1: Mixed Methodology

Source: Adapted from Nuruzzaman, 2013

To attain the objectives of this study mixed methods is used under the pragmatism paradigm using three phases of the mixed methods, which are split into stages of exploration and confirmation (Nuruzzaman, 2013). In this mixed method process the first phase includes developing research questions and objectives by reviewing literature. Based on literature, previous theoretical grounds and framework research questions and objectives, the existing research model is developed shown in third chapter under the exploratory stage. The existing model is developed using the concept of Dunlop (1958) where three actors of IRs are shown (figure 3.1).

Based on the existing model, a field study was conducted to gather the views and perceptions of actors using semi-structured questionnaires about the IRs situations in the Bangladesh RMG industry. To obtain useful construction variables relating to the IRs, the results of these interviews were transcribed and analyzed. Based on the extracted variables from the in-depth interview the conceptual research model has been developed with a an additional actor of the IRs that is IBs. The conceptual model indicated in figure 3.2 comprises of four actors of IRs such as TUs, employers, GAs and IBs.

The first phase led to the 2nd phase of the study's quantitative approach to building growth, measurement scales, and related hypotheses, survey questionnaires were then developed and pre-tested. After that, data collection was carried out using both Drop off/ Pick up (DOPU) and online method. The collected data analyzed using PLS based SEM. Finally, the findings are interpreted and addressed according to the data analyzed at the end of the confirmation stage. The qualitative phase of the model of pragmatism would raise exploratory questions about how the actors are related to the IRs. The general context, analytical aims, query format, data format and study design of the qualitative and quantitative methods are defined in table 4.2 below.

Table 4.2: Qualitative and Quantitative Research Methodology

	Qualitative	Quantitative
General framework	<p>Seek to explore phenomena</p> <p>Instruments use more flexible, iterative style of eliciting and categorizing responses to questions</p> <p>Use semi-structured methods such as in-depth interviews, focus groups, and participant observation</p>	<p>Seek to test observations about Phenomena</p> <p>Tools use a more rigid way to elicit and categorize answers to questions</p> <p>Use highly standardized strategies such as questionnaires, surveys, and formal observation.</p>
Analytical objectives	<p>To describe variation</p> <p>To describe and explain relationships</p> <p>To describe individual experiences</p> <p>To describe group norms</p>	<p>To quantify variation</p> <p>To predict causal relationships</p> <p>To describe characteristics of a population</p>
Question format	Open-ended	Closed-ended
Data format	Textual (obtained from audiotapes, videotapes, and field notes)	Numerical (obtained by assigning numerical values to responses)
Flexibility in study design	Some aspects of the research (such as the inclusion, omission, or wording of basic interview questions) are flexible.	Study design is stable from start to finish,

Source: Bernard HR. 1995

4.4 Qualitative Field Study Method

Qualitative method is used to address questions about comprehension, meaning, and interpretation from the participant’s point of view (Goedeke, Daniels, Thorpe & Du Preez, 2015; Wyverkens, Provoost, Ravelingien, Sutter, Pennings & Buysse, 2014). The systematic selection, arrangement, explanation, and analysis of textual, verbal, or visual data include qualitative studies (Kitto, Chesters & Grbich, 2008). Qualitative researchers use different means to safeguard the integrity of their studies: the evaluative criteria are

trustworthiness, credibility, applicability and consistency (Cohen & Crabtree, 2008). Qualitative field research uses inductive as an approach to the development of data collection theory as opposed to more quantitative methods that begin with hypotheses and check them by collecting data (Neuman & Wiegand, 2000).

The present study investigated the actors and their roles relating to IRs in the RMG industry of Bangladesh under the qualitative field study method using the semi-structured interview. Under this method, the face-to-face interview was conducted for having better understand and explores research subjects' opinions, behavior, experiences and phenomenon of participants (Nuruzzaman, 2013). The field study was conducted through semi-structured interviews with IRs actors in Bangladesh's RMG sector. The key objectives of this stage were to confirm the definitions, sub-variables, and items identified in the literature review and to confirm an additional actor in IRs. The qualitative field study recognized IBs as another actor of IRs in Bangladesh's RMG industry. The qualitative method was carried out so that the findings of the field study could be used to improve the existing model (as seen in figure 3.1). The results of this process helped to establish the conceptual research model to be used for designing the survey questionnaire in the quantitative part of this study.

4.4.1 Interview questionnaire development

A semi-structured interview methodology was used in the qualitative part of this research to share views and viewpoints between the investigator and the participants. From the literature review, the researcher identified the existing model shown in the chapter three (figure 3.1) of IRs by John Dunlop (1958). Moreover, from the literature another actor was identified in the field of IRs in the RMG industry of Bangladesh. The semi-structured questionnaire was designed and developed by considering literature review, existing model and the identified additional actor of IRs in RMG industry of Bangladesh to conduct the field study. Five primary questions and thirty-five probing questions were used to perform the field study. The production of interview questions was considered very critical because the qualitative approach was used to provide real-world perspectives.

In the present research, the field study has conducted with the in-depth interview with 16 participants relating to the RMG industry. The in-depth interview is done using a semi-structured questionnaire (Appendix A). From the questionnaire the first four topics reveals the roles of actors and their relationships with of IRs in the RMG industry of Bangladesh and the last topic explores the IRs situations in RMG industry of Bangladesh. The topic relating to the roles of TUs in RMG industry consisting of 7 questions, topic relating to the roles of employers has 8 questions and the topic about the roles of GAs also has 7 questions and topic relating to the roles of IBs has 6 questions were developed for the purpose of investigating the IRs in RMG industry of Bangladesh. Based on respondents' feedback, the researchers confirmed another actor of IRs that is IBs which was indentified in the literature review. However, earlier researcher Bellemere (2000) mentioned IB as an actor but was not used in the model of IRs provided by John Dunlop (Figure 3.1). The findings of the literature review were then updated and combined with qualitative phase feedback. The quantitative process therefore approved the meaning of the agreed constructs, sub-variables, and items. The qualitative part's results are then used to establish the conceptual model (Figure 3.2) in order to perform the quantitative part of this analysis.

4.4.2 Sample selection

Convenience sampling was employed in this research. In both qualitative and quantitative research, the process of convenience sampling is valid (Etikan, Musa & Alkassim, 2016). Personal contacts-based convenience sampling was applied (White, Lansky, Goel, Wilson, Hladik, Hakim & Frost, 2012). In qualitative research, there are no computations or power analyses that can be performed to determine the minimum number and types of sampling units needed a priori (Fugard & Potts, 2015). Sample size adequacy in qualitative study is relative. For certain kinds of homogeneous or essential case sampling, a sample size of 10 might be considered sufficient (Sandelowski, 1995). According to Van Kaam (1959), the sample size 10 to 50 is sufficient to discern its necessary and constituents in a qualitative research.

In the existing research, 16 participants were selected to be interviewed based on personal connections, such as TU leaders, employers, GAs and IBs. The respondents were contacted through the e-mail and mobile phone. To reach the IBs, the buying house representatives provided their kind assistance. Before the interview, the participants were sent the semi-structured questionnaire (Appendix A) where the objective of the interview was clearly briefed. The following table 4.3 illustrates the profiles of the field research interview participants and those of the organizations they worked for.

Table 4.3: Field study interview participant's profiles

Participants	Position	Nationality	Nature of Organization	Ownership
P # 1	TU Leader	Bangladeshi	Bangladesh RMG Workers Federation	Private
P# 2	TU Leader	Bangladeshi	Bangladesh RMG Workers Federation	Private
P# 3	TU Leader	Bangladeshi	Bangladesh RMG Workers Federation	Private
P # 4	TU Leader	Bangladeshi	Bangladesh RMG Workers Federation	Private
P # 5	Employer	Bangladeshi	Manufacturing and Exporting RMG	Private
P# 6	Employer	Bangladeshi	Manufacturing and Exporting RMG	Private
P# 7	Employer	Bangladeshi	Manufacturing and Exporting RMG	Private
P # 8	Employer	Bangladeshi	Manufacturing and Exporting RMG	Private
P# 9	Registrar of TUs	Bangladeshi	Government Agent	Government
P# 10	Director (DoL)	Bangladeshi	Government Agent	Government
P # 11	Director (DIFE)	Bangladeshi	Government Agent	Government
P# 12	Inspector (DIFE)	Bangladeshi	Government Agent	Government
P #13	International Buyer	American	Global Brand	Private
P # 14	International Buyer	German	Global Brand	Private
P #15	International Buyer	Indian	Global Brand	Private
P #16	International Buyer	Italian	Global Brand	Private

Source: Adapted from Nuruzzaman, 2013

4.4.3 Data collection

The semi-structured questionnaire with five open end and thirty-five probing questions was used for interview for collecting the data in the qualitative phase. In this phase data were also collected by considering the existing model and literature outcomes. The interviews were scheduled as per the participants' convenience. Some participants took the questionnaire for planning in advance and gave the researcher a particular date and time for the interview. Before the interview, the participants were briefed on the research goals. The researcher committed the participants' confidentiality and privacy would be respected and preserved. It was also assured and promised that in the writing of the research for academic publication, none of the participants cooperating in the research could be named or identifiable, and that any data submitted would be aggregated for general patterns, not for a specific person or organization.

Each interview session lasted from approximately half an hour to an hour. A total of 16 interviews were successfully conducted. During the interview, the participants were very much helpful and interested to this study. The participants have given their valuable opinions and shared experiences regarding the questions they were asked. The participants were much cooperative because they had been contacted through personal relationships. During the interview, the participants were requested to allow recording their speech by using the mobile recorder. Most of the participants allowed but very few did not. In case of the respondents who did not allow to use the recorder, key points were noted down. For data analysis, the verbatim transcriptions of all recorded interviews were completed to ensure accurate data from the discussions of participants, body language, and others (Merriam, 1997, Nuruzzaman, 2013).

4.4.4 Data analysis

To analysis the data gathered from the field study, first the interviews were transcribed by using the verbatim of mobile records and the notes written down during the interviews. Then, to examine and evaluate the collected data, the content analysis approach was used (Lune & Berg, 2017) to assess the relationship between the ideas, the interview data and the theoretical

context (Siltaoja, 2006). In order to scrutinize the transcripts and evaluate constructs, sub-variables, main items and the relation between the items, the content analysis approach is also used. During the content analysis, the transcriptions of the conducted interviews were gone through very carefully to uncover key words or themes. After uncovering the key words, the relevant items, variables, and corresponding constructs were labeled and categorized. Then, with identical characteristics previously observed in the literature, the structures, variables, and objects were balanced. Similarities and discrepancies between variables under each object were found among the responses from all participants in the data analysis procedure and were given a new name after being combined. Finally, by adding a new IRs actor seen earlier in Chapter Three and Figure 3.2, a new conceptual model of IRs was developed.

4.4.5 Results and Interpretations

4.4.5.1 Constructs and Items

Through the content analysis of the data obtained from the interviews, the reality and accuracy of constructs, sub-variables, and items were examined. The views of the participants are considered very carefully during the data collection, since they share their views based on their expertise and real-world experience. The data captured reflected the participants' responses in the sense of IRs in the Bangladesh RMG industry. All participants in the field study were found to agree with the established IRs actors with little variation. Participants acknowledged the relationship between the established actors and their variables with the IRs in Bangladesh's RMG industry. Particularly, from the interviews with the respondents the roles and actions of IBs are clearly identified. The involvement of IBs can be characterized regarding the intensity of their present roles in the IRs in RMG industry of Bangladesh. The new relationships that have developed between the IRs and the IBs along with TUs, employers and GAs compel us to consider the idea that IBs indeed constitute a unique actor in IRs particularly in the RMG industry of Bangladesh.

In fact, as stated earlier, the emphasis of the field study was on validating the actors defined in both the current and the conceptual research model. Examples of links identified by the interview participants are given in the quotations from the transcripts below.

The participant # 1 during the interview stated, *“I think it is 100% necessary to have TUs in the RMG industry of Bangladesh but it needs to have the good practices in the TUs. However, sometimes the employers much influenced the TU leaders for their favors. The government is also influenced by this industry and sometimes it shows its more interest to the employers than the employees.”*

He also stated that *“If there any dispute arises then we inform it to the employers and management then meet with both parties trying to solve the dispute, if it is not possible then we go to the DIFE then the inspectors of DIFE called the both parties and try to solve the problems. Again, if it is not possible then we need to go to the tribunal. For maintaining the buyers order and their audit, the employers are very much attentive to maintain the work environment of the factory. We always try to stand side the employees as the leaders of them.”*

Participant # 2 mentioned during the interview, *“It is fact that the employers are more attentive to us than the government. The factories try to act in accordance with the compliances issues prescribed by the foreign buyers because if the audit report of the representative of the buyers will negative, then the buyers cancel their orders. It should be mentioned here that the company should pay more attention towards the food of the employees because in the factory the employees have to work for a long time.”*

This participant # 2 also said that, *“It is true that government agents are more favorable to the employers because most of the members of the parliament are businesspersons. The changing situations after the Tazreen and Rana Plaza disaster the foreign buyers are the key players here their compliances bound the employers to make the factories safe and good.”*

The participant # 3 has shared his experience regarding the RMG industry that, *“it is true that the labors are adaptive with any environment. We see some factories there is the arrangement*

of collective bargaining between the TUs and the employers. The rules and regulations in the factories are not practicing accurately. It is also true that the labor always search for the better opportunity where gets more pay then he leave the present organization. Sometimes, it is happen that without any notice the workers remain absence this is the commitment problem of some workers. We always try to fight for the labors against the employers where the employers are more benefited. It can be said that the factories are better than the 10 years ago particularly after the Rana Plaza collapse because of the pressure of foreign buyers.”

Another participant # 4 stated that, “After the Rana Plaza tragedy now the factories are giving more attention to the working environment because without good environment according to the codes of conduct of the foreign buyers the factory will lose the order and will shut down. The factories are now bound to follow the rules and regulations. If there any dispute with the management then we try to meet with the owners but the middle management always keep us away from the owners for that the owners could not know our problems directly this gap is very important. If the management act such, then we go for strike or gherao but sometimes we go to the government like the DIFE and file our complaints then the DIFE called the both parties and try to solve the problems.”

During the interview regarding the roles of employers of RMG industry one of the participants (P # 5) stated that “If you provide benefits to the workers then they will give you return. At the beginning of our organization we provided the food facilities for the workers but after sometimes we were bound to stop those facilities because workers made complaints about the canteen authority regarding nepotism like food distribution, quality etc. The issues of compliance, we are trying to implement all the compliance issues prescribed by the buyers. Since the industry is providing many jobs so, the government should pay special attentions to the industries of our country i.e. the RMG sector. Many countries do not know Bangladesh but after the tragedy, they know Bangladesh as the Savar tragedy. This is the problem of media. They focused negative thing more. It should be mentioned here that the ultimate willing of my organization is to introduce the profit sharing culture. If workers will be given the opportunity to share profit then they will own the organization. Simultaneously this will be their extra

income against their efficiency. We will create a culture that we are not doing charity rather we are giving the scope the workers to increase their productivity to increase sales and profit so that they can share the profit.”

The participant # 6 quoted that *“Buyers are playing a vital role in the RMG industry of Bangladesh after the Rana Plaza disaster. The buyers have given more attention towards the healthy environment because it builds positive employee relations, reduce employee turnover rates and labor unrest, enhances worker productivity, increases outsider interest, create valuable reputation for the company. We are always aware that there should not be the gap between the employees and employers. We have the opportunity to one to one communication.”*

He also mentioned regarding the roles of government and mentioned that, *“We are trying to implement all the compliance issues prescribed by the international buyers. However, to be frank, we could follow 100% compliances issues because we are not getting long-term loan from the bank. In other country like Malaysia their bank, provide them long term loan for their industrial development. They get the loan of 15 years we just get the loan for 7 years. For this, we could not invest in the infrastructure. After Rana Plaza tragedy, it was internationally focused.”*

At the time of the conversation regarding the roles of employers, the participant # 7 opined, *“I think my workers are giving time and labor here so they should be evaluated. I am not God, I just a medium to provide them opportunity to work and earn. We provide incentives for their extra production and extra earnings for the organization. We are giving the space to do TU but sometimes we feel very discomfort regarding some activities of the trade union leaders. This is very harmful for the organization. However, in some factories trade unions are doing well for their members, they participate meetings for problem solving in the industry. They also plays role to counseling the workers so that they will be aware regarding their works and rights. Government are now very much concern regarding the working environment and labor rights in this sector. Moreover, government always monitors the implication of labor laws and regulations. After the Rana Plaza disaster the foreign buyers are now acting as the check post”*

The participant # 8 during the interview mentioned, *“We are trying to bring up good relations with the workers. We welcome the trade unions. We think trade unions are very much needed to ensure and bargain regarding their rights prescribed by the laws. Compliance factors prescribed by the foreign buyers work environment and others are most significantly influence the workers in Bangladesh. After Rana Plaza Building collapse the whole condition of the RMG sector have been changed because the whole world buyers and other countries give their attention on workers working condition, health & safety, labor right and the wages of RMG workers. Moreover, after this disaster in RMG sector, government also took some steps for improving the work environment and wages of RMG worker of Bangladesh.”*

From the view points of the government participant # 9 who is one of the agents of the government shared his experience regarding the IRs in RMG industry that, *“In fact the owners have huge investment in their industry as well they are generating a large scale employment of particularly the village people. For this reasons we should evaluate the contribution of the employers positively. Yes, there may be some problems in this sector but it should take it normal. Because this is a sector of huge employees for why for running this sector there may be some gaps between the expectations and reality among the employers, workers, and other.”*

Regarding the minimum wages and implications of labor act, he further stated that, *“The minimum wages of the labor are determined by the wages board according to the terms and conditions of the laws and considering the location of the factories as well the life style of the workers. You should also consider the ability of the employers because employer is one of the vital factors of the industry. Considering productivity and the experience of the workers is considered to determine the wages. The latest minimum wages of Tk. 8,300 is satisfactory to the fresh workers. They also get the overtime. If you would like to sustain the industry you have to consider the productivity of the employers.”*

The participant # 10 quoted that, *“At present in Bangladesh there are 906 trade unions are registered in RMG industry. Trade union is the association of workers so it has the role in the RMG industry. They try to present the demands of the workers to the owners. I think this is a good platform for the workers to protect their rights and interests. If there any gap arises*

between the workers and employers then they meet with each other and bargain the issues but if it is not settled then they come to us and we try to settle the matter as the mediator. In fact if there is trade union then the workers get the lawful protection.”

This participant is also stated that, “If the labors and union creates trust in the mind of the employers that TUs are not harmful for his organization then they feel comfortable to do union in his organization. In case of dispute, the employers always stay in the win position. It is true that the wages of the labors in Bangladesh is much cheaper than any other country of the world. The role of government is positive in this sector because the government always expects a good working environment, sound relations among the parties of the factories.”

The participant # 11 has mentioned the overall scenario regarding the roles of the actors of RMG industry of Bangladesh. About the roles of IBs, this participant stated that, “After the Rana Plaza collapse international buyers is very much concern regarding the safety health issues of the workers in the sector. Now buyers become the pressure group for the employers of the sector so that no rights will be violated in the industry. The international buyers do not compromise the workplace safety issues regarding the workers. Buyers also provide security to the trade union activities.” The participant also added that, “I cannot say that the owners are not following the labor laws, now they are trying to follow the laws. However, this will be better if there creates the trust between employers and TUs. I positively think that in future the employers will do better for the industry.”

The participant # 12 who is one of the GAs provided his views regarding IRs in the RMG industry of Bangladesh that, “RMG is a growing industry so every parties should come forward to make the sector stable and sound. As the government have some bodies like department of labor, department for inspection of factories and establishment, minimum wage board, labor welfare trust who assist to protect the labor rights and interests. As the government agent, we uphold the ILO convention 87 and 98 regarding collective bargaining and freedom of association. In fact for having a sound industry the all parties like employees, employers, the government and buyers should act and work positively for the benefits of all.

Without the coordination and cooperation among the all parties it is not possible to build a sound RMG industry.”

During the interview, this participant also mentioned that, *“I surely think that TU is very much needed in the RMG industry. Now the TUs are participating collective bargaining and some of the factories are giving such opportunities.*

The Participant # 13 who is one of the buyers of the RMG of Bangladesh stated during the interview that, *“Some factories which are non-compliance are not our concern but the compliance factories guided by us are very much conscious regarding the workers, work environment and their interests. Some factories create some problems regarding the salary particularly in the occasion of EID but this rate is insignificant. The factory authority has to ensure the salary in time otherwise; we file complaints against the factories and proceed to cancel the orders. We think trade unions are very much important to ensure the rights of the labor. The industry should provide the opportunity of forming union and the union should actively work for upholding the rights and benefits of the workers.”*

He also added that, *“If there any dispute in the factories then the owners has the more responsibilities to solve the problems by the discussion with the TUs. Now the TUs are aware regarding the working environment of the factories but it needs more awareness.”*

Another participant # 14 who stated about the RMG industry and the roles of the concerned actors quoted as follows, *“We are very much concern regarding the workplace safety and health in the factories. The factories have to fulfill the Accord and Alliance guidelines to operate their industry. If there, any problem or disappearance then we take it very seriously. As the stakeholder of the RMG industry of Bangladesh, we promote the trade union activities for the betterment of workers. If any factory management takes any action regarding the hindrance of freedom of doing trade union then we alert to the owners and make sure to give them the opportunity to do union. If any leader is terminated for doing trade union in the industry then we take necessary actions to re-employment the leader in his respective job. Though we have some negative concept of trade union in Bangladesh, particularly some*

leaders misguided the workers, which are very harmful for the sector. In this regard, we try to assist the workers and the factories. The government of the Bangladesh is very much helpful and friendly to the RMG industry of Bangladesh and as well to us as the clients.”

Participant # 15 who is another IB of the RMG industry of Bangladesh stated that, *“Last few years in Bangladesh buyers are providing some requirement regarding the compliances like the construction must be according to the Accord and Alliance and in every organization there must be the fire doors so that the factory workers will rescue easily if there any accident. If this is not satisfied then the Accord and Alliance will not provide certificate and as per our buyers never provide orders to those factories. Our buyers are always serious regarding the workplace safety. We bound the factories to introduce the compliance department in the factories. It is fact that if the factory authorities do not ensure the satisfactory working environment then we cancel our orders and pay attention to Vietnam and Cambodia. It should mention here that the RMG industry of Bangladesh has more improvement regarding the labor rights, work environment etc. However, it should be carried on. The government of the country is also playing more attentive roles for this sector”*

The participant # 16 stated that, *“It is true that if there unfair practices in the industry then we alert owners and provides the opportunity to follow our codes of conduct and the laws formulated by the government. Sometimes, we are not satisfied regarding the collective bargaining in the industry. In the factory, participating committee is introduced in place of the trade union who are elected and are very much friendly to the owner. I feel that if the owner alive then the labor alive if the owner will problem then so to the labor. Therefore, each party should think each other. If there have such mutual trust between the employers and TUs then most of the problems will be solved. We can see many factories are giving the opportunity of the collective bargaining and agreements. I think every party is following the laws but it needs more emphasized by all parties. The labors also should aware.”*

He further quoted that, “Government also should take the necessary steps and support to the industrial units to manage sound relations by monitoring the implications the rules and regulations formulated by them.”

Taking into consideration the following claims and quotations from participants of the field study, it can identify a number of constructs, sub-variables, and items. Initially, 37 items under 6 sub-variables and 5 constructs were identified. After scrutiny and combination, the results presented in Table 4.4 on similar items were achieved. The table shows the frequency of the views mentioned by the participants during the field study.

Table 4.4: Construct and Items of Industrial Relations in RMG of Bangladesh

Construct	Items	Participants															
		1	2	3	4	5	6	7	8	9	10	11	12	13	14	15	16
1. TUs	Participants are happy with freedom of association.	√	√	√	√	√		√		√	√		√	√	√		√
	TUs pay their attention to practice labor laws.	√	√		√	√		√		√	√	√	√	√	√	√	√
	TUs are alert for good working environment.	√	√	√	√	√		√	√	√		√	√	√	√	√	
	TUs are accomplished.	√	√	√	√			√	√	√	√	√	√	√	√	√	√
	Participants have confidence on the power of TUs of collective bargaining.	√	√		√	√		√		√	√	√	√		√	√	√
	TUs get opportunities to solve dispute in RMG.		√	√	√	√	√	√	√	√	√	√	√	√	√	√	√
	TUs ensure investigation	√		√		√	√	√	√	√	√	√	√	√		√	√

Construct	Items	Participants															
	issues of harassment and misconduct allegations.																
	TUs have the roles to make industry a safer place for work.	√	√	√	√	√		√		√		√	√	√		√	√
2. Employers	Employers follow labor laws.			√		√	√	√	√	√		√	√	√	√	√	√
	Employers ensure all sorts of work environments in the industry.			√		√	√	√	√	√		√	√	√			√
	Employers are happy of having TUs.			√	√	√	√	√	√	√	√		√	√	√		
	Employers take care about the collective bargaining.				√	√	√	√	√		√	√	√	√	√	√	√
	Employers take steps to resolve the dispute in the RMG.	√	√	√	√	√	√	√	√	√	√	√		√	√	√	√
	Employers take the buyers' codes of conduct positively.	√		√		√	√	√	√	√	√	√	√	√	√	√	√
	Employers' values are mention worthy.			√	√	√	√	√	√	√	√		√	√			√
	Employers think union's problems are their problems.			√		√	√	√	√	√	√		√	√	√	√	√
3. GAs	GAs is supportive in practices labor laws.	√	√	√	√	√	√	√	√	√	√	√	√	√	√	√	√
	GAs is serious for sound working	√	√	√	√	√	√	√	√	√	√	√	√	√	√	√	√

Construct	Items	Participants																
	environment.																	
	GAs upholds freedom of association in RMG.	√	√	√	√	√	√	√	√	√	√	√	√	√	√	√	√	
	GAs satisfied of having collective bargaining in RMG.	√	√	√	√		√	√	√	√	√	√		√	√		√	
	GAs plays roles to solve dispute.	√	√	√	√	√	√	√	√	√	√	√	√	√	√	√	√	√
	GAs monitors for implication of buyers' codes of conduct.	√	√	√		√	√	√	√	√	√	√	√	√	√	√	√	√
	All actors cooperate to the GAs.	√	√	√	√	√	√	√	√	√	√	√	√	√	√	√	√	√
	GAs thinks that buyers are important actor in RMG industry.	√	√	√	√	√	√	√	√	√	√	√	√	√	√	√	√	√
4. IBs	IBs protect the unfair labor practice.	√	√	√	√	√	√	√	√	√	√	√	√	√	√	√	√	
	IBs ensure sound working environment in the RMG industry.	√	√	√	√	√	√	√	√	√	√	√	√	√	√	√	√	
	IBs promote freedom of associations.	√	√	√	√		√	√	√	√	√	√	√	√	√	√	√	
	IBs focused on the collective bargaining.	√	√	√	√		√	√	√	√	√	√	√	√	√	√	√	
	IBs are satisfied with dispute resolution procedure in the sector.	√		√	√		√		√	√	√	√	√	√	√	√	√	
	Buyers' codes of conduct are important for sound RMG.	√	√	√	√	√	√	√	√	√	√	√	√	√	√	√	√	√

Construct	Items	Participants															
5. IRs	All actors' practices labor laws in the RMG.			√	√	√	√	√	√	√	√	√	√	√	√	√	
	All actors maintains working environment in their respective place.	√		√		√	√	√	√	√	√	√	√	√	√	√	
	RMG acknowledges freedom of association.	√	√	√	√	√		√		√	√	√	√	√	√	√	
	In RMG, there is the scope for collective bargaining.	√	√	√	√	√	√	√	√	√	√	√	√	√	√	√	
	RMG always appreciates its actors for dispute resolution.	√	√	√	√	√	√	√	√	√	√	√	√	√	√	√	
	RMG discloses the maintenance of buyers' codes of conducts.	√	√	√	√	√	√	√	√	√	√	√		√	√	√	
	The RMG has well developed and organized work policies			√	√	√	√	√	√		√	√		√	√	√	

Source: Adapted by the Author

In the field study, 37 items were finally identified. Remarkably, all participants recognized 13 items. These items were GAs' support in labor laws practice, their involvement for sound working environment, upholding freedom of association, roles to solve dispute, buyers' importance in RMG and cooperation from the all actors of IRs in the RMG industry of Bangladesh. Along with the roles of GAs, all participants recognized regarding the roles of

IBs in protecting the unfair labor practice, ensuring sound working environment, promoting freedom of associations, focusing on the collective bargaining and their codes of conduct. Moreover, the all participants recognized the appreciations of the industry for dispute resolution and the scope for collective bargaining in the sector.

From the field study of total 7 items are acknowledged by 15 participants out of 16 regarding the roles of TUs in the RMG industry of Bangladesh such as the attention of TUs in practicing labor laws and their opportunities to solve dispute in the industry. The participants quoted regarding the roles of employers like their steps to resolve the dispute and attitudes towards the buyers' CoC. The 15 participants acknowledged regarding the monitoring of government for implication of buyers' CoC in the sector. The same participants recognized that all actors maintains working environment in their respective place, RMG acknowledges freedom of association, and RMG discloses the maintenance of buyers' CoC.

Out of 16 participants, 14 participants recognized the items regarding TUs' attention to the practice of labor laws and their roles for working environment in the industry. These participants also opined the roles of TUs to ensure investigation issues of harassment and misconduct allegations and acknowledgement of all actors in the RMG industry of Bangladesh to practices labor laws in maintaining sound IRs. Moreover, 13 participants recognized 9 items relating to the roles of the actors and their relationships with IRs in RMG industry of Bangladesh. Besides, 12 participants indicated 3 items relating to the IRs in the sector and rest of the 1 item is recognized by 11 participants out of 16.

However, IRs derived from the earlier literature recognized the indicators, which are used to measure the roles and relationships of the actors and notable support from participants interviewed in the field study. Both participants agreed that the players in Bangladesh's RMG industry play important roles in IRs. During the field study four participants belong to the TUs, one or two of them have the negative views regarding the roles of employers and the GAs in maintaining the IRs in RMG. On the other hand, the employers as the actors also have

some negative observation regarding the roles of workers and TUs in the IRs of RMG industry. Ultimately, it was made clear from the interviews that sound IRs would be possible in Bangladesh's RMG whenever the actors played their proper roles. The focus of the field study, as previously described, was essentially on validating and improving or developing the frameworks, sub-variables, and items in the current and conceptual research model.

4.4.5.2 Cross-examination of conceptual model

The content analysis and its outcomes shown in the table 4.4 regarding the validation and augmentation or development of the constructs, sub-variables and items relating to the IRs in RMG industry of Bangladesh are used to cross-examination of conceptual model shown in the chapter three and figure 3.2. The following table 4.5 was developed after cross-examination to confirm the final number of constructs used in the conceptual model of this study (Nuruzzaman, 2013). The following table 4.5 was formulated based on the scrutiny of the transcript, the investigation of the qualitative data at the research point and the opinion of the appropriate participant.

Table 4.5: Constructs and Corresponding Opinion

Constructs	Participants															
	1	2	3	4	5	6	7	8	9	10	11	12	13	14	15	16
TUs	√	√	√	√	√		√		√	√	√	√	√	√	√	√
Employers	√	√	√	√	√	√	√	√	√	√	√	√	√	√	√	√
GAs	√	√	√	√	√	√	√	√	√	√	√	√	√	√	√	√
IBs	√	√	√	√	√	√	√	√	√	√	√	√	√	√	√	√
Outcome	IRs															

Source: Adapted by the Author

The above table 4.5 shows that all participants gave their full consent regarding the relationships of the roles of employers, GAs and IBs for maintaining IRs in the RMG industry of Bangladesh. However, two participants number 6 and 8 who did not give their consents regarding the roles of TUs for the IRs in the field under study.

4.5 Conceptual Model

The existing model was drawn from the literature review (figure 3.1) developed by John Dunlop in which three actors of IRs were mentioned. After the field study, the constructs, sub-variables, and items were identified and the existing model was modified with the four actors and developed the conceptual model (figure 3.2). There are 24 links between the constructs and the sub-variables with the IRs considered in the conceptual model of the study mentioned in below table 4.6.

Table 4.6: Constructs, Sub-variables and Links with the Industrial Relations

Constructs	Links between sub-variables and outcome	Justification for Acceptance and Rejection of sub-variables and outcome	Acceptance/ Rejection
TUs	Regulatory framework practices → IRs	Supported by literature review Supported by field study	Accepted
	Working environment→ IRs	Supported by literature review Supported by field study	Accepted
	Organizing association→ IRs	Supported by literature review Supported by field study	Accepted
	Collective bargaining→ IRs	Supported by literature review Supported by field study	Accepted
	Dispute resolution→ IRs	Supported by literature review Supported by field study	Accepted
	Buyers' codes of conduct→ IRs	Supported by field study	Accepted
Employers	Regulatory framework practices → IRs	Supported by literature review Supported by field study	Accepted
	Working environment→ IRs	Supported by literature review Supported by field study	Accepted
	Organizing association→ IRs	Supported by literature review Supported by field study	Accepted
	Collective bargaining→ IRs	Supported by literature review	Accepted

Constructs	Links between sub-variables and outcome	Justification for Acceptance and Rejection of sub-variables and outcome	Acceptance/ Rejection
		Supported by field study	
	Dispute resolution→ IRs	Supported by literature review Supported by field study	Accepted
	Buyers' codes of conduct→ IRs	Supported by field study	Accepted
GAs	Regulatory framework practices → IRs	Supported by literature review Supported by field study	Accepted
	Working environment→ IRs	Supported by literature review Supported by field study	Accepted
	Organizing association→ IRs	Supported by literature review Supported by field study	Accepted
	Collective bargaining→ IRs	Supported by literature review Supported by field study	Accepted
	Dispute resolution→ IRs	Supported by literature review Supported by field study	Accepted
	Buyers' codes of conduct→ IRs	Supported by field study	Accepted
IBs	Regulatory framework practices → IRs	Supported by field study	Accepted
	Working environment→ IRs	Supported by field study	Accepted
	Organizing association→ IRs	Supported by literature review Supported by field study	Accepted
	Collective bargaining→ IRs	Supported by field study	Accepted
	Dispute resolution→ IRs	Supported by literature review Supported by field study	Accepted
	Buyers' codes of conduct→ IRs	Supported by literature review Supported by field study	Accepted

Source: Adapted by the Author

The above table 4.6 shows the links between the sub-variables and IRs in accordance of the constructs mentioned earlier in chapter three in the conceptual model. All sub-variables are accepted to make the link with the IRs according to the literature review and field study. Such linkages of the sub-variables and the outcome of this study confirmed the conceptual model for testing the relations of the constructs and the IRs using the survey. According to the final conceptual model, hypotheses were developed to test by using survey instrument (structured questionnaire).

4.6 Quantitative Study Method

In the mixed method study, two methods can be used sequentially. The first approach is used to stimulate the development of the second. Both qualitative and quantitative approach is used in corresponding as separate solutions to the similar problem (Kovacs, Morgan, Levine & McCrann, 2012; Hammarberg et al., 2015). In this study, qualitative approach used to understand opinions and experiences of the participants. After analyzing the field study constructs, sub-variables and items were identified for developing theories and concepts using the relevant literature. In the field study, another prominent actor IBs of IRs confirmed which is identified in the relevant literature. Then, the existing research model got a change. Accordingly, the additional actor of IRs helped to develop a modified research model where the IBs are included along with existing constructs TUs, employers, and GAs.

After developing the conceptual research model and conducting the qualitative field analysis, the quantitative part of this study is aimed to test the relationships between actors and IRs. From the conceptual model, seven hypotheses were extracted to test their significance relations with the outcome of this study. This quantitative part is used to recognize the variables using statistical tools. This method quantifies variation to predict causal relationships for the purpose of confirm hypotheses about phenomena. In a more rigid form of eliciting and categorizing answers to questions from surveys and organized population sample findings, highly structured approaches such as questionnaire instruments used to test hypotheses (Bernard, 1995). In the present study, the quantitative approach is used to measure the relationships between the actors and IRs in RMG industry of Bangladesh by testing the hypotheses drawn from the conceptual model. For this, the survey method is therefore considered better fit for this quantitative part of this research, and a questionnaire-based survey is adopted (Nuruzzaman, 2013).

4.6.1 Research Design

According to the Creswell (2017), a research design is planned process for conducting research. The quantitative phase of this study is carried out at a certain point in time; as such, this study is a cross-sectional study in which data has been gathered at a single point in time (Uma Sekaran & Bougie, 2016; Hossain, 2019). Data was collected from the actors of RMG industry of Bangladesh to understand their relationships in maintaining IRs in the sector. Moreover, the quantitative part of this present study is correlational in nature, which is designed to explore a relationship, association, or interdependence among the independent and dependent variables (Kothari, 2004; Uma Sekaran & Bougie, 2016). The researcher collected relevant data using the structured questionnaire using the observed variables to analysis the constructs shown in the conceptual model (figure 3.2). The opinions collected by the survey instrument were analyzed to test the hypothesized variables identified in the conceptual model of this study.

4.6.2 Sampling Technique and Sample Size

4.6.2.1 Sampling Technique

Sampling is defined as the act, process, or technique of selecting a representative part of a population for the purposes of determining parameters or characteristics of the entire population (Emerson, 2015). Moreover, element in the population has known non-zero likelihood of being selected by the use of a random selection method where randomization is not important in the selection of a sample from the population of interest as non-probability sampling. Instead, to determine the elements are included in the study, subjective approaches are used (Etikan, Musa & Alkassim, 2016). Non-probability sampling is a technique of sampling where the samples are obtained in a process that does not give equal chances of being included to all participants or units in the population (Suen, Huang & Lee, 2014). It would be superlative to use the entire population in every form of study, but in most cases, since the population is almost finite, it is not feasible to use every subject. This is the rationale behind the use by most researchers of sampling techniques like convenience sampling (Sandoval, 2016).

Convenience sampling is a form of non-probability sampling where members of the target population are included who meet certain practical requirements, such as easy accessibility, geographical proximity, accessibility at a given time, or willingness to participate (Brown, 2004). Because of the close proximity to a researcher, i.e. those that are easier for the researcher to reach, when subjects are selected, the researcher conducts a convenience sampling (Etikan, Musa & Alkassim, 2016). In addition, the researcher has the liberty to pick the sample for ease sampling (Guest, Bunce & Johnson, 2006). Convenience sampling, which is also known as judgmental sampling, is used when a researcher intends to make a sample analysis to verify a specific standard (Bagozzi & Yi, 1988). For these reasons, the convenience sampling technique has been used to select the sample of this present study.

4.6.2.2 Sample Size

Researcher selected the RMG industries in Bangladesh who are the members of BGMEA and are 100% export-oriented, TU federations, Department of Labor Law, Department of Inspection for Factories and Establishment were used to conduct the survey. Moreover, the researcher selected some Buying Houses to contact and reach the IBs. The industries and the offices are located in the Dhaka city, Gazipur, Savar, Ashulia and nearby. The survey was done by questionnaires were distributed to 600 respondents. Out of 600, a total of 352 responses were received and 327 out of 352 were usable. This sample size fulfills the required sample size requirement, i.e. 205 respondents by taking 99 percent confidence level, 0.5 standard deviation, and ± 1 percent error margin (Ali, Kim & Ryu, 2016).

According to Hill (1998), a sample size an above 200 are enough for sufficient data analysis. In addition, by negating the commonly used criterion for calculating the minimum sample size with the use of 10 responses per indicator, Westland (2010) showed that the sample size needed is not a linear function of the indicator count alone (Westland, 2010; P 476). The lower bound on sample size for our SEM model is 150 cases at 0.3 predicted effect sizes, 0.80 desired statistical power level, 5 number of constructs, 34 number of observed variables and 0.05 likelihood level (Soper,2020), using Westland's (2010) software statistical algorithm to compute the absolute minimum sample size. Thus, for the present analysis, the 327 questionnaires with an answer rate of 54.50% were considered satisfactory.

4.6.3 Questionnaire Development

The Likert scale is commonly used as a basic psychometric scale for assessing reactions to the thoughts and attitudes of individuals towards a topic or subject matter. It uses questionnaires, often used interchangeably with a ranking scale, but for assessing views, there are other types of rating scales (Messick, 1989). This measurement scale has a system that encourages the design and administration of surveys, and the coding and review of results. Scales are used to rank judgments of objects, events, or other persons from low to high or from poor to good and disagree to agree by respondents. A scale is a line between the highest to the lowest points and between these two extremities has intermediate points (Dimitrov, 2014).

One obvious criterion for selecting the number of categories of scale is the willingness of participants to differentiate within the categories. The key explanation that a vast number of divisions are used is to increase the scale efficiency (Cummins & Gullone, 2000). Many experiments have shown that if a scale consists of a relatively small number of objects, reliability could be much increased if a six or seven point scale is used (Komorita & Graham, 1965). Many researchers have used a Likert scale of 7 points and have a core neutral value. Hair (2015) and Nuruzzaman (2013) stated that when selecting size divisions, the two options were choosing either an odd number or even number.

For the two scales 6 and 7, a 6-point scale will be chosen because they allow for improved measuring precision (Li, 2014; Nemoto & Beglar, 2014), as first, there is no intermediate level (i.e. no point on the ruler is called no range or intermediate range). Second, middle categories cause statistical issues in that rating scale analyzes sometimes indicate that neutral categories interrupt calculation in the way that they do not match statistical models well or are disordered. Third, a neutral category is needless because studies should include only things on a questionnaire that respondents should answer, and this should be verified by piloting (Wolfe & Smith, 2007).

Furthermore, the option of a 6-point Likert scale was also based on the study of Fong (2005) that Asian ethnicity participants seemed to prefer the middle score or to be non-partisan in their responses as this pattern was presumed to produce a research result that was not attractive. Therefore, since the analysis was carried out in Bangladesh, which has an Asian

population, this study used a 6-point Likert scale. In fact, it is reported that over the past 15 years, the implementation of SEM has focused primarily on the Likert scale (Byrne 2008) and has likewise been implemented in this study.

All the construct and items that have attempted to measure in this study have been included in the questionnaire under different sections with each section comprising a relevant set of questions to facilitate the collection of data from the respondents in respect of those constructs. The survey questionnaire has two sections. Section A comprises 9 items relating to the respondents' demographic profile. Section B comprises 7 items relating to TUs, another 7 items relating to employers, 7 items relating to GAs, 6 items relating to IBs which are the independent variables, and 7 items relating to IRs as the dependent variable of this study.

The measurement of all items are based on the 6 sub-variables of the study, regulatory framework practices, working environment, freedom of association, collective bargaining, dispute resolution and buyers' codes of conduct. The measurement of all sub-variables is made using different scale formats. For example, for section B, TUs items, a 6-point Likert scale has been used, which has been anchored with 1 (strongly disagree) and 6 (strongly agree), while IRs items were calculated using a different 8-point Likert scale ranging from strongly disagree (1) to strongly agree (8) (Hossain, 2019, p.118).

This study has been conducted on the four actors of IRs in RMG of Bangladesh. Among the four, three respondents (Union Leaders, Factory Owners, and Government Representatives) are fluent in the Native (Bengali) language. Therefore, the questionnaire was first designed in English and then translated into the Bengali to make the questionnaire readable as well as understandable to these three respondents. The English version questionnaire is used for the Foreign Buyers because they are not fluent in the Bengali language. Both the English version and the translated questionnaire were sent to an expert of the Department of English in the University of Rajshahi to ensure the accuracy of the terms used in the questionnaire

(Appendix B). After going through the questionnaire, the experts opined that both the versions were reasonably comparable to each other. The respondents were also asked to score their opinion as per an 8-point Likert scale on the statements about IRs.

4.6.3.1 Instrument Development

This section explains, through the positions of its four players, the creation of measurement instruments based on the conceptual paradigm for IRs in the RMG industry. Six sub-variables and 34 objects are present in the model. The demographics of the respondents were calculated by nominal and ordinal scales (Malhotra, 2004) and interval scales were measured for the remainder of the 34 assessment instrument objects (Malhotra, 2004). On a scale of '1' (strongly disagree) to '6' (strongly agree), the respondents were asked to select the right number. The 6-point Likert scale made the following choices possible: '1' (strongly disagree), '2' (disagree), '3' (somewhat disagree), '4' (somewhat agree), '5' (agree) and '6' (strongly agree). Cooper and Schindler (2008) repeated that the choice of the respondents to select the middle answer would result in a central error in the trend. The middle answer to a 'neither approve nor disagree' 7-point Likert scale was then omitted and the final outcome of a 6-point Likert scale was used. Moreover, the items of IRs are calculated using a different 8-point Likert scale ranging from strongly disagree (1) to strongly agree (8).

The latent construct is assumed to be induced by reflective items: any adjustment to or elimination of an object does not alter the outcome or the fundamental existence of the associated latent construct. Therefore, internally coherent and associated elements of the reflective framework are used (Fornell & Bookstein 1982; Nunnally & Bernstein 1994). All the sub-variables such as regulatory framework practice (RFP), working environment (WE), organizing association (OA), collective bargaining (CB), dispute resolution (DR) and buyers' codes of conduct (BCoC) are conceptualized as reflective.

4.6.3.2 Questionnaire section A: Demographic measures

The aim of this section is to gather demographic information about the respondents involved in this study such as name, gender, age, marital status, education, job status, form of service, experience, monthly salary and firm size are included in the demographic data. The demographic assessment objects, measurement claims, and related references are presented in Table 4.7.

Table 4.7: Measurement of Demographics

Variables/Items	Statement/Measures	Sources(references)
Gender (Do1)	Nominate gender	(Morris and Venkatesh 2006; Moores and Chang 2006)
Age (Do2)	Nominate age group	(Moores and Chang 2006)
Marital status (Do3)	Nominate the married or unmarried	(Hossain, 2019)
Education (Do4)	Nominate the highest level of education	(Hossain, 2019)
Employment status (Do5)	Nominate as the actor in the industry	Developed for this study
Service type (Do6)	Nominate the type of service	(Hossain, 2019)
Experience (Do7)	Nominate the level of Experience	(Nuruzzaman, 2013)
Monthly salary (Do8)	Nominate the range of income	(Hossain, 2019)
Firm Size (Do9)	Nominate the size of the firm	Developed for this study

Source: Adapted from Nuruzzaman, 2013

4.6.3.3 Questionnaire section B: Measuring Roles of Actors in Industrial Relations

The research model is constructed based on the previous literature relating to the actors of IRs, TUs, employers, GAs and IBs. The variables and sub-variables concerned also have been chosen and picked up for the study purpose from the available previous works relating to the same areas.

Table 4.8: Research Measurement Instrument

Constructs	Sub-variables	Items	Source
TUs	RFP, WE, OA, CB, DR and BCoC	7	Deery et al. (1999); Fleming & Peetz (2005); Himi & Rahman (2013); Duah & Danso (2017); Kaium (2020) and field study.
Employers	RFP, WE, OA, CB, DR and BCoC	7	Deery et al. (1999); Snape et al. (2000); Simms (2015); Kaium (2020) and field study.
GAs	RFP, WE, OA, CB, DR and BCoC	7	Hossain & Arefin (2015); Abun et al. (2018) and field study.
IBs	RFP, WE, OA, CB, DR and BCoC	6	Fleming & Peetz (2005); Absar (2012); Alam et al. (2017); Kaium (2020) and field study.
IRs	RFP, WE, OA, CB, DR and BCoC	7	Deery et al. (1999); Waters et al. (2013); Duah & Danso (2017) and field study.

4.6.3.3.1 Trade unions

Trade unions are associations of employees who can organize voluntarily to support and defend the rights and interest of their members through the employers-employees interaction (Budeli, 2009). This association is organized to solve the problems of the members (Ibrahim, 2013; Rajesh & Manoj, 2015). The leaders of this association engage in negotiations with their respective employers to assurance decent working environment, equal pay, workplace security for their members (Howell, 2005) through the collective bargaining process (Siddiqua et al., 2014). A stable and strong TU can discuss regarding the terms and conditions of employment to the employers (Bacharach & Lawler, 1981). TUs play a vital role that is useful in constructive cooperation between employees and employers (Visser, 2016). TUs have foremost tasks to serve their members in their work (Hyman, 2007). Strong and recognized TUs required for industrial peace (Preena, 2020). In the case of TUs, 7 question items has been picked up from Deery et al. (1999); Fleming & Peetz (2005); Himi & Rahman (2013); Duah & Danso (2017); Kaium (2020). The ideas and concepts drawn from the in-depth field study have been used for enhancing the TUs instrument. Of the total items of

instrument TU2, TU4, TU7 have been taken from Duah & Danso, (2017), TU1 has been taken from Himi & Rahman, (2013), TU3 from Fleming & Peetz, (2005), TU5 from Kaium, (2020), TU6 from Edison & Rajakrishnan, (2014) has been taken from the works of Deery et al., (1999) with modifications to suit the purpose.

Table 4.9: Items relating to Trade Unions

Items	Original terms	Adapted terms
TU1	The actors feel a sense of pride of having the provisions regarding trade union in the BLA, 2006	I feel a sense of pride of having trade unions.
TU2	The workers feel satisfied in their organization with proper practices of labor law.	I feel satisfied of labor law practices.
TU3	It needs effective roles of trade union in negotiating wages and working conditions for the sound employment relations.	Trade unions play roles for effective working environment.
TU4	The actors get a sense of personal accomplishment from their work.	I feel the need of freedom of association.
TU5	The workers have the confidence in the management's ability to deal collective bargaining.	I think trade unions play roles in collective bargaining.
TU6	Organizations provide opportunities to its parties to solve dispute that crates good employment relations.	My industry provides the opportunities to trade unions to solve dispute.
TU7	Factory follows the codes of conducts.	Trade unions follow the buyers' codes of conduct properly.

4.6.3.3.2 Employers

Employers hire employees and pay for their services (McCleary et al., 2017). Employers also determine the employment terms and conditions and make an agreement with the employees (Clark, 1968). They negotiate regarding the benefits and allowances with the employees for their works and duties (Baumann-Pauly et al., 2015). The employers are legally responsible for working conditions and enforce labor laws for the decent employment relations (Noe et al., 2015). While preparing the questionnaire questions have been set to know the perceptions of the respondents about RFP, WE, OA, CB, DR and BCoC. The sources for development of the questionnaire has been from the work of Deery et al. (1999); Snape et al. (2000); Simms (2015); Kaium (2020) and field study. Particularly, the items of EM2 and EM6-EM7 were

taken from (Deery et al., 1999), item EM4 taken from (Simms, 2015); items EM3 and EM5 were taken from (Snape et al., 2000) and the rest item EM1 was taken from (Kaium, 2020).

Table 4.10: Items relating to Employer

Items	Original terms	Adapted terms
EM1	The employers encourage the workers in the organization to work in accordance with rules and regulations.	Employers encourage to work in accordance with labor laws.
EM2	The organization would accept any type of job assignment in order to keep working sound.	Employers ensure almost any type of conditions of working in the industry.
EM3	The workers feel sense of pride being part of the trade union.	Employers encourage freedom of association.
EM4	Collective bargaining develops a sense of self-respect and responsibility among the employees.	Employers interested in collective bargaining process.
EM5	The employers think that the union's problems are their problems.	The employers think the employees problems are their problems.
EM6	The compliance really inspires to be followed by the all parties.	The employers strictly follow buyers' codes of conduct.
EM7	The organization thinks that the values of parties and the organization should be similar for good employment relations.	Employers' values and practices are very similar.

4.6.3.3.3 Government Agent

According to Wirtz & Birkmeyer (2015) described that GAs are the bodies of the government who rule the people of its region. The GAs formulate and govern the rules and policies to exercise the laws. It exercises legislative, political and constitutional powers through state customs (Uzoh, 2015). GAs aims to improve economic growth, jobs and development (Liu & Hanauer, 2011). Thus, the GAs supports entrepreneurship through a range of initiatives to improve the business climate, covering their launch, growth and efficiency (Mason & Brown, 2014). GAs is a key unit in IRs (Hayter & Lee, 2018). In this section seven items have been taken for measurement purposes. A 6-point Likert scale, ranging from 1 (strongly disagree) to 6 (strongly agree), has been used for measuring the variables concerned. Items relating to GAs like GA1 - GA2 and

GA4 - GA7 have been collected from the works of Abun et al. (2018) and GA4 taken from Hossain and Arefin (2015) to be included in the questionnaire to bring out the perceptions of the respondents about the IRs situations under study. In addition, the findings of the field study were also used to explain the GAs.

Table 4.11: Items relating to Government Agent

Items	Original terms	Adapted terms
GA1	Government helps by formulating labor laws and rules, which structured the relation among the actors to secure harmony in the IRs.	Government agents ensure of practicing regulatory framework.
GA2	The employees can communicate openly to other employees without hesitation	Government agents can deal openly with working environment.
GA3	The government always shows respect to organizing association for creating and enabling a sound IRs.	Government agents always show respect to organizing association.
GA4	Government feels satisfaction in the organization because there is opportunity for bargaining.	Government agents ensure opportunity for collective bargaining.
GA5	Employees support one another where there is need for dispute resolution.	Government agents assist in dispute resolution.
GA6	International buyers take feedback from the parties regarding their compliance and interests.	Government agents are keen to follow buyers' codes of conduct.
GA7	Government can easily get the cooperation of organization in employment relations programs activities.	Government agents get all sorts of assistance from the all parties in RMG.

4.6.3.3.4 International Buyers

Parties who are purchasing products and services are buyers (Han et al., 1993). IBs are importers of final goods according to their requirements (Cannon & Perreault, 1999). In the RMG industry, IBs enforce not only order-based requirements but also overall operational climate specific to manufacturers such as working hours, protection of workers, occupational atmosphere, contamination of the climate, manufacturing cycle, procurement of raw materials, quality management and regulation, social responsibility etc (Islam et al., 2014; Rahim, 2017). They requested that structural legislation should be implemented across the industry for health, safety and welfare, the right to collectively assemble and negotiate, letter

of employment and the minimum wage for the RMG employees (Ansary & Barua, 2015). Compliance with IBs is an important requirement for the success of the RMG manufacturers (Tarannum & Ansary, 2018; Alamgir & Banerjee, 2019) for bringing peaceful IRs.

Previously published articles were used as the source for measuring the relationships of the actors and IRs under this study. While preparing the questionnaire 6 items concerning IBs were taken from the works of Fleming and Peetz, 2005; Absar, 2012; Alam et al., 2017; Kaium, 2020 and field study. Items of IB2, IB3, and IB6 were picked up from Kaium, (2020), item of IB1 was taken from Fleming & Peetz, (2005), items IB4 and IB5 were taken from Absar, (2012) and Alam et al. (2017) respectively.

Table 4.12: Items relating to International Buyers

Items	Original terms	Adapted terms
IB1	Protection from the possibility of unfair treatment.	Foreign buyers promote regulatory framework practices to protect the unfair.
IB2	The management makes sure that everyone works safety in work environment.	Foreign buyers make sure that everyone is safe in work environment.
IB3	Management encourages workers to participate in decisions which affect their interest	Foreign buyers encourage all parties to participate in their respective associations.
IB4	Collective bargaining is encouraged in RMG	Foreign buyers encourage collective bargaining.
IB5	The organization follows proper grievance handling procedure in the face of conflict and disciplinary actions for bringing sound IR.	Foreign buyers are satisfied in dispute resolution procedure.
IB6	Management makes sure to design safety routines that are meaningful and actually work.	RMG industries are very much alert to maintain foreign buyers' codes of conduct.

4.6.3.3.5 Industrial Relations

The relationships among employers, employees, government, buyers and the institutions and organizations by which mediated through this relationships is called IRs (Al Faruque, 2009; Duara & Mallick, 2019; Hyman, 2013). In general, IRs include fields such as the relationships among employers, TUs, GAs, IBs relating to collective bargaining for working environment, workplace dispute resolution, freedom for association, contribution of buyers for their workplace compliances, labor laws (Akharumere, 2019; Al Faruque,

2009). This is the outcome of this research work. A total of seven items have been included in the questionnaire concerning the IRs, which were taken from the works of Deery et al. (1999); Waters et al. (2013); Duah & Danso (2017) and the field study as well.

The 8-point Likert scale was used to measure respondents' attitudes and expectations about IRs in Bangladesh's RMG industry. On a scale of '1' (strongly disagree) to '8' (strongly agree), the respondents were asked to select the appropriate number. The 8-point Likert scale made the following choices possible: '1' (strongly disagree), '2' (disagree), '3' (moderately disagree), '4' (somewhat disagree), '5' (somewhat agree), '6' (moderately agree), '7' (agree) and '8' (strongly agree). Any score above 5 was deemed a positive answer to the question, while any score below 5 was deemed negative (Hossain, 2019). Out of these seven items of the questionnaire IR1, IR2, and IR4 have been taken from the work of Waters et al. (2013). Items IR3, IR5, and IR6 picked up from the work of Deery et al. (1999). Moreover, the rest item IR7 was taken from the work of Duah & Danso (2017).

Table 4.13 Items relating to Industrial Relations

Items	Original terms	Adapted terms
IR1	The organization should consider its actors when practicing laws.	My industry practices labor laws.
IR2	The actors have confidence that the organization can maintain its working environment accordingly.	My industry maintains its working environment accordingly.
IR3	The current Constitution acknowledged freedom of association.	My industry acknowledges freedom of association.
IR4	All actors allow collective bargaining to establish a healthy working environment.	In my industry, collective bargaining procedures are followed.
IR5	The organization always appreciate the parties the involvement of dispute resolution.	My industry always appreciates dispute resolution.
IR6	The organization needs to disclose to the concerned parties regarding its compliance decisions.	My industry discloses its buyers' codes of conduct.
IR7	The work policies are well developed and organized for securing good relations.	I have the faith that work policies of my industry are well developed and organized.

4.6.3.4 Demographic Information

Demographic information was collected in the first section during the survey. Earlier studies show that actors demonstrate singular concentration in organizational services, and this can be influenced by their demographic characteristics (Mirzagoli & Memarian, 2015). Therefore, nine questions with regard to respondents' demographic information were demonstrated in the questionnaire.

Table 4.14: The Demographic Questionnaire

Gender	1. Male	2. Female
Age	1. 20 - 30 Years	2. 31 - 40 Years
	3. 41 - 50 Years	4. 50 Years and Above
Marital Status	1. Unmarried	2. Married
Education	1. Below SSC	2. Below HSC
	3. Below Bachelor	4. Below Masters
	5. Masters and Above	
Employment Status	1. Union Leader	2. Factory Owner
	3. Government Representative	4. Foreign Buyer
Service Type	1. Permanent	2. Temporary
	3. Probationary	4. Others
Experience	1. Less than 2 Years	2. More than 2 and 5 Years
	3. More than 5 and 10 Years	4. More than 10 Years
Monthly Salary	1. USD 100 – USD 200	2. USD 200 - USD 300
	3. USD 300 - USD 400	4. USD 400 - USD 500
	5. USD 500 - USD 600	6. USD 600 and More
Size of Firm	1. Small Scale	2. Medium Scale
	3. Large Scale	

4.6.3.5 Pre-Test

In the process of questionnaire development phase, pre-testing is very important which identify the mistakes, errors, sequence and instructions in the questionnaire (Estes & Tiliouine, 2014). It reduces the complications and unclear wording or biases in the survey instrument (William, 2003). In the pre-test stage total eight respondents from TU leaders, factory owners, government officials, and foreign buyers and their representative are given the questionnaire purposively to check the appropriateness of the items. Moreover, six academicians from the Faculty of Business Studies in the University of Rajshahi who all have foreign degree are selected using purposive sampling to participate to perform the pre-test. This group of participants assessed the appropriateness and clarity to complete the questionnaire.

The participants are requested to assess the items according to the objectives including the questionnaire, layout, and sequence of the questionnaire, clarity of the words, sentences, and meaning and the appropriateness of the questions for measuring the actual information about the items and constructs in this study. In addition, the time the participants take to complete the questionnaire also recorded. In this phase, the participants took around 15-20 minutes to complete the questionnaire. After completing the questionnaire, each of the respondents requested to provide their remarks and suggestions for all the questionnaire items. The participants remarked that the questions in the questionnaire are clear, logical, and easy to understand. Then, the questionnaire was finalized with changes according to the feedback, opinions, and perceptions of the participants of the study. The complete questionnaire has been annexed in appendix-B.

4.6.3.6 Pilot Test

Before the actual survey, pilot test is very important because it's a small-scale replica of the main survey (Thabane, Ma, Chu, Cheng, Ismaila, Rios & Goldsmith, 2010). This test helps to clarify the validity and reliability of the items of the questionnaire (Hossain, 2019). According to Johanson and Brooks (2010), "Pilot test are repeatedly suggested to concentrate on a

variety of issues, including preliminary scale or instrument development. Specific concerns such as item difficulty, item discrimination, internal consistency, response rates, and parameter estimation in general are all relevant.” The pilot test showed that the construct was both accurate and reliable while offering the ability to add refinements to the testing tool (Dikko, 2016). The pilot study’s sample size depends on the precise intent of the study. In previous some researchers showed that minimum 30 representative participants are recommended if the purpose is to check the internal consistency, validity, and reliability of the items of the survey instrument (Cocks & Torgerson, 2013; Hertzog, 2008; Johanson & Brooks, 2010). Other researchers stated that from 10 to 40 samples is sufficient for a pilot survey (Hassan & Muzza, 2006; Dikko, 2016).

In the present study, 100 questionnaires were distributed to the union leaders, factory owners, government representatives, and foreign buyers for the pilot study. Of these 100 questionnaires, 42 questionnaires were returned giving a response rate of 42%. The alpha coefficient of a Cronbach greater than or equal to 0.70 is suggested as appropriate for each scale (Hair, Sarstedt, Hopkins & Kuppelwieser, 2014). SPSS (version 23) is used in the present study to test the internal accuracy of the items used for the survey instrument. The following table 4.15 shows that by analyzing the data collected during the pilot test showed the values ranges from 0.777 to 0.936. These 42 samples are excluded from the final sample test.

Table 4.15: Summarizes the Internal Consistency Reliability for Each Measure

Cronbach’s Alpha of Variables from Pilot study Serial Number	Construct	Items	Cronbach’s Alpha
1	TUs	7	0.797
2	Employers	7	0.936
3	GAs	7	0.855
4	IBs	6	0.777
5	IRs	7	0.905
Total		34	

4.6.4 Data Collection Procedure

The researcher communicated with the respondents relating to the RMG industry of Bangladesh such as union leaders and factory owners, government representatives from DoL, DIFE, Registrar Office of TUs, foreign buyers and their representatives who are working in the buying houses. A total number of 600 questionnaires were distributed to the respondents using DOPU method and online instrument such as google form link. In the first page of the questionnaire, there was introduction of the survey, the objectives of the survey and the anonymity issue of the individuals.

In order to ensure an optimum response rate, the researcher kept on making continuous follow-ups by phone calls and paying personal visits to the respondents. However, in the first round the response was so poor because of the lack of close contact with the respondents due to the COVID 19 pandemic. From the first week of July 2020, the researcher made the personal visit and mobile phone calls to the respondents and requested to response the questionnaire. The researcher again visited RMG factories provided the questionnaire to the employers along with the sending of google form link to their smart mobile phone number so that they can easily provide their opinions. The owners of RMG industry are also requested to send the link to their colleagues. In this regards, the president of BGMEA and her office provided cordial support to reach the respondents and get their responses.

During the factory visit, some union leaders were found but they were not agreed to provide the response of the questionnaire inside the factory premises. The registrar of TUs and the director of DoL provided their support to contact with the TU leaders. According to the information by some factories and office of TUs registrar researcher visited the TU offices situated in Ashulia, Baipail, Zirabo, Chondra, Gazipur Chowrasta and Dhaka city where face to face survey was conducted with the TU leaders. Along with some trained personnel, the researcher conducted the face-to-face survey with the union leaders in-group. The union leaders were ensured regarding their anonymity and their privacy about themselves and their opinions. It was ensured that no individual opinion would be presented in any way to the study or to the factory owners.

For the response of the questionnaire by the GAs, the researcher visits the offices of DoL, and DIFE in person. The Registrar of TUs, directors, deputy directors, officers, and inspectors of the respective offices are requested to fill up the questionnaire. In this regards, the GAs felt more comfortable to provide their responses of the questionnaire using google form. They also supported to provide the mobile numbers and emails for sending the soft copy of questionnaire and the link of the form. According to their provided numbers, the researcher sent the questionnaire and the link for the GAs response.

In case of the survey on the foreign buyers, the employers of some factories provided their kind assistance. Moreover, in this regard, the human resources of the buying houses showed their great interest to reach the foreign buyers and their representatives. The Alumni of the Department of Management Studies, University of Rajshahi who are working in the buying houses in the RMG industry helped to reach their clients who are the foreign buyers. According to the contact numbers and email addresses, the researcher sent the questionnaire and the link for the foreign buyers' response. The responses of the questionnaires were collected within a 3-month period (July 2020 to September 2020). A total of 352 responses were collected out of 600, and of the collected 352 responses 327 have been found to be usable. This sample size reaches the necessary sample size requirement mentioned earlier.

4.7 Data Preparation

4.7.1 Missing Data

Missing data exists in most behavioral research (Acock, 2005; Allison, 2001). In several studies, non-responsive objects cause missing data such as respondents complete a survey but may not provide answers for each item. Experts have not reached agreement on the amount of incomplete information that is troublesome. In case of missing data, 5% missing is as the cutoff recommended by Schafer (1999). Bennett (2001), however, indicated that statistical studies are likely to be skewed when more than 10% of data is missing (Peng, Harwell, Liou & Ehman, 2006). According to Schlomer, Bauman and Card (2010), "missing data can be

handled with three strategies: mean substitution (a poor method of handling missing data), multiple imputation (MI), and full information maximum likelihood (FIML) (with MI and FIML being recommended methods). MI, FIML does not impute missing values into newly created data sets (and thus is not technically an imputation method) but rather estimates parameters on the basis of the available complete data as well as the implied values of the missing data given the observed data.” This study aimed at using FIML strategy if there any missing data.

4.7.2 Data Distribution (Treatment of Normality and Non-Normality)

Before any systematic statistical analysis, it is important to determine the normality of the results. Otherwise, false inferences and incorrect conclusions may be drawn. According to Ghasemi and Zahediasl (2012), researchers frequently test the normality of residuals, subsequently fitting a linear model to the data to confirm whether the normality estimation of the model is fit. There are two key methods of normality evaluation: graphical and numerical. Graphical interpretation has the benefit of allowing good judgment in cases where numerical tests can be over or under-sensitive to determine normality. A great deal of expertise is required to determine the normality of data using graphical methods to prevent incorrect interpretations. In this regard, numerical method is more suitable (Mishra, Pandey, Singh, Gupta, Sahu & Keshri, 2019).

The performance of the normality tests, namely the Kolmogorov-Smirnov test, the Anderson-Darling test, the Cramervon Mises test, and the Shapiro-Wilk test. Previous researches have shown that the Shapiro-Wilk test is the most sensitive normality test. Thus, the Shapiro-Wilk approach is used to assess the normality of data in this analysis when the four normality measures are available in a statistical kit (Ahad, Yin, Othman & Yaacob, 2011; Ghasemi & Zahediasl, 2012).

4.7.3 Common Method Variance

Cross-sectional studies of relationships between attitudes and behaviors are vulnerable to common method variance (CMV) inflation of correlations (Lindell & Whitney, 2001). In the sense of PLS-SEM, common method bias is a phenomenon induced by the method of measurement used in a SEM sample, and not by the network of causes and effects in the model being studied (Kock, 2015). CMV occurs when the calculation method incorporates systemic variation into the measurements. Richardson, Simmering, and Sturman (2009) noted that CMV is the structural variance of error that is shared between variables calculated by the same source or process. This systemic variance of error can cause traditional method bias and the calculated relationships between variables or measures can also be biased (Jakobsen & Jensen, 2015; Campbell & Fiske, 1959). Method biases can have a major effect on their reliability, validity of products and covariation between latent constructs (Podsakoff, MacKenzie & Podsakoff, 2012).

The effect of CMV can often not be completely removed by procedural remedies, since all procedural remedies are generally not available in all circumstances. The other procedural remedies could therefore minimize the effect of CMV to some degree. Therefore, the use of statistical remedies to monitor the effects of CMV on research results is useful. Harman's Single-Factor Test, Partial Correlation Procedures, Correlation Matrix Method and the Calculated Latent Marker Variable Approach (Tehseen, Ramayah & Sajilan, 2017) are the most common or most suggested statistical remedies that can either be used before or after data analysis to reduce common bias. In this study, Harman's single-factor test is used to assess the CMV in this research with the threshold to 50%. If the latent factor explains more than 50% of the variance, then common method bias may be present (Eichhorn, 2014).

4.7.4 Data Analysis Technique

For analyzing collected data in order to testing the hypotheses of this study the statistical techniques such as SPSS, PLS-SEM are used (Hair, Sarstedt, Hopkins & Kuppelwieser, 2014; Henseler, Ringle, & Sarstedt, 2009). Due to its success within both academic and business circles, SPSS was selected for its most widely used tool. SPSS is also a flexible

package that enables several different kinds of analysis, transformation of data, and output forms (Arkkelin, 2014). Babin, Hair and Boles (2008); Bagozzi (1994); Hulland (1999) claimed that because it allows researchers to evaluate complete theories and principles, SEM has become a quasi-standard in science. Bollen (1989) defined the ability of SEM at the observation level to evaluate latent variables and test relationships at the theoretical level between latent variables.

Moreover, SEM technique is used to examine the linear relationship among the observed variables for assessing a research model (Hair, Sarstedt & Ringle, 2017). According to Hair et al. (2014); Hair et al. (2017) and Martínez-Ferrero and García-Sánchez (2016) recommended to use SEM because it is also considered as a significant tool and technique to explicate the relationships among multiple variables and also applied in analysis of multivariate for theory testing and causal modeling. It also has the ability to evaluate the uni-dimensionality, reliability, and validity of individual constructs (Henseler et al, 2015) and usage of multiple regression and factor analysis to simultaneously estimate a set of relationships of interrelated dependency (Hair et al., 2014). Another important reason for using the SEM to analyze latent constructs, specifically, the analysis of underlying links among latent constructs (Bagozzi & Yi, 1988; Henseler et al., 2015).

4.7.5 Model Specification

For the analyzing data using PLS-SEM, first it needs to formulate a model based on theories and concepts. It is required to specify the location of exogenous or endogenous constructs (Hair et al., 2014). In this present study, the conceptual research model (figure 3.2) formulates TUs, employers (EM), GAs and IBs are the exogenous constructs, which act like independent variables. Endogenous variable is explained by other variables in the model as the dependent variable. In the present research model, IRs is endogenous construct, which is the outcome. The measurement model is assessed based on the relationship between the indicators and the

latent variables (Bagozzi & Yi, 1988; Monecke & Leisch, 2012). The following figure 4.2 shows the exogenous and endogenous constructs, inner and outer model indication.

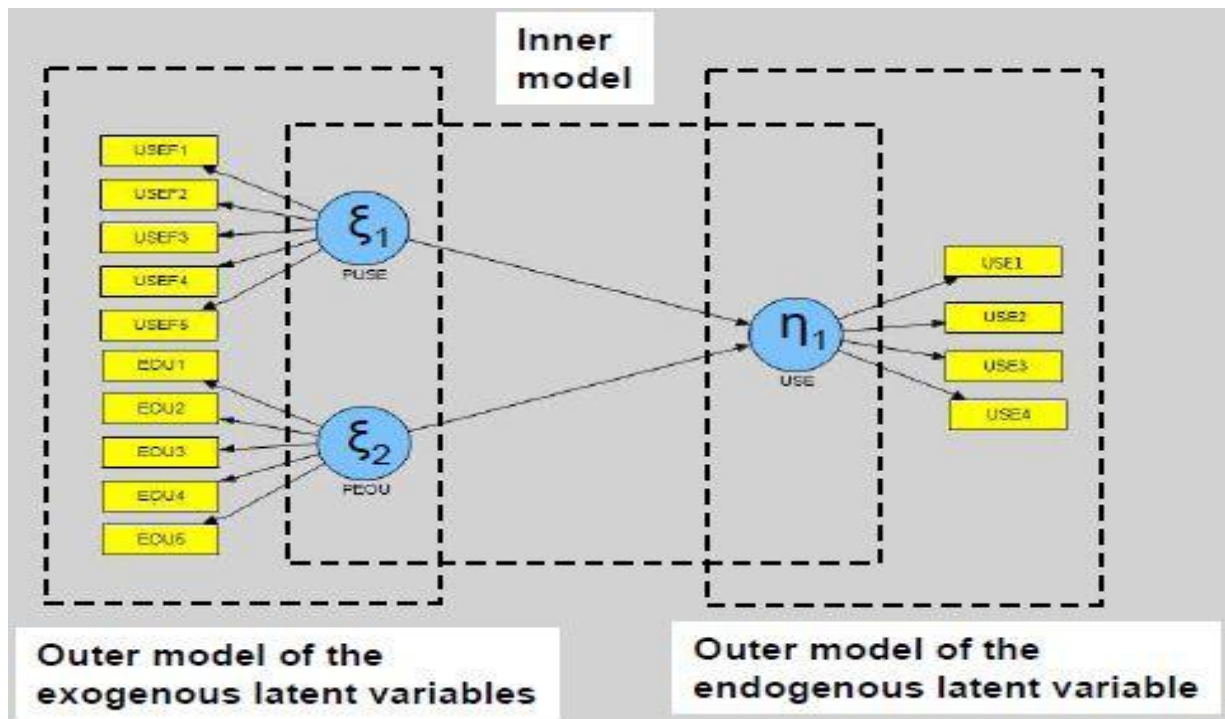

Figure 4.2: Model Indicator

4.7.6 Reflective and Formative Measurement Models

The distinction between formative and reflective measures is significant because to allocate meaningful relationships in the structural model (Anderson & Gerbing, 1988). The following table 4.16 shows the three theoretical considerations and three empirical considerations, which separate formative models from reflective ones.

Table 4.16: A Framework For Assessing Reflective and Formative Models: Theoretical and Empirical Considerations

Considerations	Reflective model	Formative model	Relevant literature
Theoretical Considerations 1. Nature of construct	Latent construct is existing -Latent construct exists independent of the measures used	Latent construct is formed -Latent constructs is determined as a combination of its indicators	Borsboom, Mellenbergh & Heerden (2003, 2004)
2. Direction of causality between items and latent construct	Causality from construct to items -Variation in the construct causes variation in the item measures -Variation in item measures does not cause variation in the construct	Causality from items to construct -Variation in the construct does not cause variation in the item measures -Variation in item measures causes variation in the construct	Bollen & Lennox (1991); Edwards & Bagozzi (2000); Rossiter (2002); Jarvis, Mackenzie & Podsakoff (2003)
3. Characteristics of items used to measure the construct	Items are manifested by the construct -Items share a common theme -Items are interchangeable -Adding or dropping an item does not change the conceptual domain of the construct	Items define the construct -Items need not share a common theme -Items are not interchangeable -Adding or dropping an item may change the conceptual domain of the construct	Rossiter (2002) ; Jarvis, Mackenzie & Podsakoff (2003)
Empirical Considerations 4. Item intercorrelation	Items should have positive intercorrelations -Empirical test: internal consistency and reliability accessed via Cronbach alpha, average variance extracted, and factor loadings (e.g., from common or confirmatory factor analysis)	Items can have any pattern of intercorrelation but should possess the same directional relationship -Empirical test: indicator reliability cannot be assessed empirically; various preliminary analyses are useful to check directionality between items and construct	Cronbach (1951); Churchill (1979); Diamantopoulos & Siguaw (2006); Nunnally & Bernstein (1994)

Considerations	Reflective model	Formative model	Relevant literature
5. Item relationships with construct antecedents and consequences	<p>Items have similar sign and significance of relationships with the antecedents/consequences as the construct-</p> <p>Empirical test: content validity is established based on theoretical considerations, and assessed empirically via convergent and discriminant validity</p>	<p>Items may not have similar significance of relationships with the antecedents/consequences as the construct</p> <p>-Empirical test: nomological validity can be assessed empirically using a MIMIC model, and/or structural linkage with another criterion variable</p>	<p>Bollen and Lennox (1991); Diamantopoulos and Winklhofer (2001); Diamantopoulos and Siguaw (2006)</p>
6. Measurement error and collinearity	<p>Error term in items can be identified</p> <p>-Empirical test: common factor analysis can be used to identify and extract out measurement error</p>	<p>Error term cannot be identified if the formative measurement model is estimated in isolation</p> <p>-Empirical test: vanishing tetrad test can be used to determine if the formative items behave as predicted Collinearity should be ruled out by standard diagnostics such as the condition index</p>	<p>Bollen and Ting (2000); Diamantopoulos (2006)</p>

Source: Adapted from Coltman, Devinney, Midgley and Venaik, (2008)

According to the table 4.16, reflective refers to the general attitude in which each dimension reflects separate attitudinal dimensions. In contrast, formative indicators cause or form the latent construct, or it represents different dimensions of the latent constructs (Bagozzi & Yi, 1988; Esposito et al., 2010). In the present study, all the constructs are modeled as the reflective measurements. Therefore, the constructs TUs, EM, GAs, IBs, and IRs used in this research are reflective.

4.7.7 Outer Model Evaluation Indicators

According to Henseler et al. (2015), once the model has been developed, the next stage is to evaluate the outer model. The outer model (Figure 4.3) shows that all the indicators are reflective. A representative collection of all possible items within the construct is established by reflective indicators (Coltman, 2008) and relates to the construct by loadings. For evaluating the external model, both validity (convergent and discriminant) and reliability (Hossain, 2019) needed to be calculated.

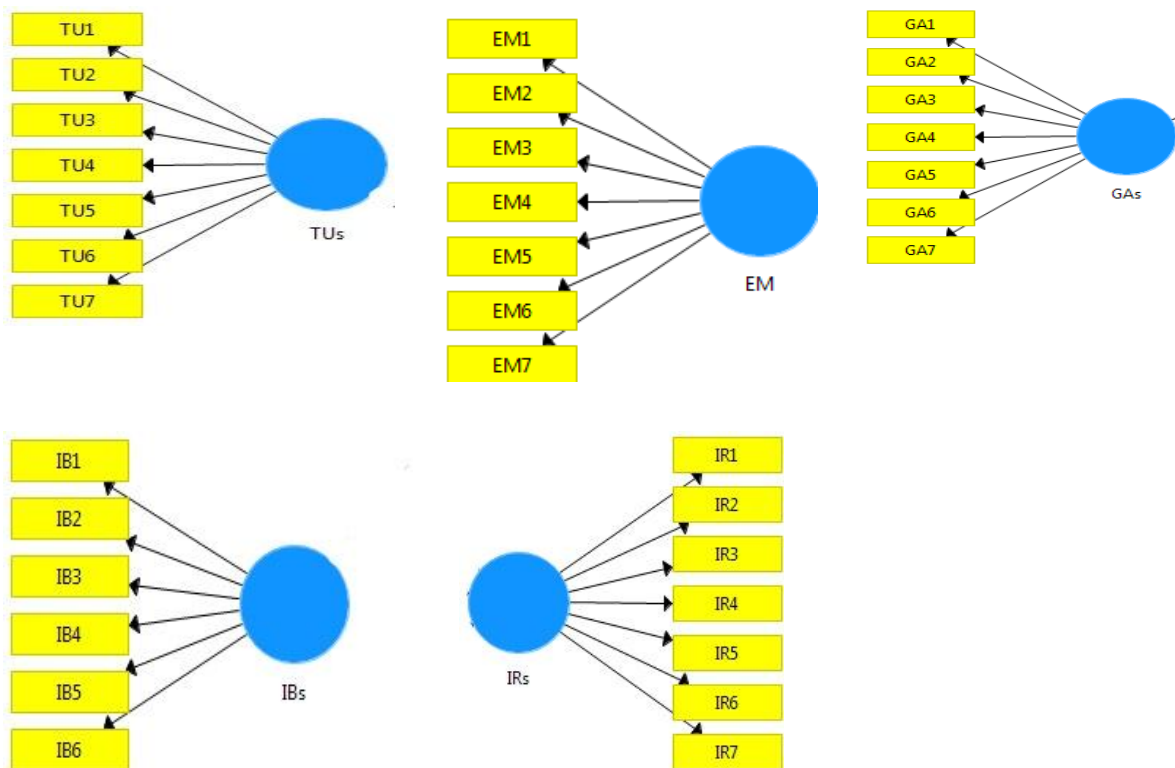

Figure 4.3: Outer Model Indicator

4.7.8 Convergent Validity

Convergent validity is the assessment to calculate the correlation degree of several agreed-upon measures of the same construct. In addition, it refers to the degree to which various measures designed to tap the same construct correlate with each other (Hair, Hult, Ringle & Sarstedt, 2017a). The factor loading of the predictor, composite reliability (CR) and the average variance extracted (AVE) have to be considered in order to establish convergent validity (Hair et al., 2014).

4.7.8.1 Indicator Reliability

The reliability of the indicator is the proportion of indicator variance described by the latent variable. Values differ between 0 and 1. According to Hair et al. (2014), the value of the outer loadings should be greater than 0.60, and if the exclusion of the indicator with outer loadings between 0.40 and 0.60 leads to a rise in CR and AVE, it should be considered for deletion (Hair et al., 2014). Indicators with external loading below 0.40 should always be excluded (Hair et al., 2011; Hulland, 1999).

4.7.8.2 Composite Reliability

The composite reliability instrument is used to assess the internal accuracy of the construction indicators of a study. Earlier internal consistency was measured by Cronbach's alpha but now it is considered as the traditional approach. In this regard, at present researchers are using CR to measure internal consistency of the indicators of construct by PLS-SEM (Hair et al., 2017). The CR is determined in PLS-SEM by measuring the loading values of the indicators of constructs (Hair et al., 2017). During the years 2006 to 2010, 85 papers using PLS were published in four major journals. As proof of acceptable CR, the authors most frequently cited cutoffs values of the products are 0.70 (Aguirre-Urreta, Marakas & Ellis, 2013; Chin, 1998; Fornell & Larcker, 1981; Gefen, Straub & Boudreau, 2000; Nunnally, 1978; Werts, Linn & Jöreskog, 1974).

4.7.8.3 Average Variance Extracted

After measuring the internal consistency of the indicators of constructs then it needs to measure the validity of the indicators by using the AVE (Hair et al., 2014). As the part of convergent validity the indicators of AVE is considered and the loading value must be higher than 0.5, which will reflect at least 50% of the indicators explaining the construct (Hair et al., 2011).

4.7.9 Discriminant Validity

Discriminant validity guarantees that a measure of construction is empirically distinctive and reflects phenomena of interest that are not captured by other variables in a structural equation model (Hair et al., 2010). According to Farrell (2010), “if discriminant validity is not established, constructs have an influence on the variation of more than just the observed variables to which they are theoretically related and, as a consequence, researchers cannot be certain results confirming hypothesized structural paths are real or whether they are a result of statistical discrepancies.” In this study, two major measures are used for discriminant validity, firstly, Fornell-Larcker criterion for assessment of the cross-loadings and secondly, heterotrait-monotrait ratio of correlations (HTMT) as a new approaches (Henseler, Ringle & Sarstedt, 2015).

4.7.9.1 Discriminant Validity (Fornell and Larcker)

The square root of the AVE is compared by this approach to the correlation of latent constructs (Hair et al., 2014). Rather than the variance of other latent constructs, a latent construct can better describe the variance of its own predictor. The square root of the AVE of each construct should therefore have a higher value than the correlations to other latent constructs (Hair et al., 2014).

4.7.9.2 Discriminant Validity (HTMT)

The other indicator of discriminant validity is the correlation ratio of heterotrait-monotrait (HTMT). Henseler et al. (2015) proposed the Monte Carlo simulation analysis, the superior performance of this approach and found that HTMT is able to achieve higher rates of specificity and sensitivity. A lack of discriminant validity is indicated by HTMT

values near 1. Comparing it to a predefined threshold means using the HTMT as a criterion. Some authors (Kline, 2011) propose a threshold of 0.85. Gold, Arvind and Malhotra (2001) also disagreed with him and suggested a value of 0.90.

4.7.10 Inner Model Evaluation

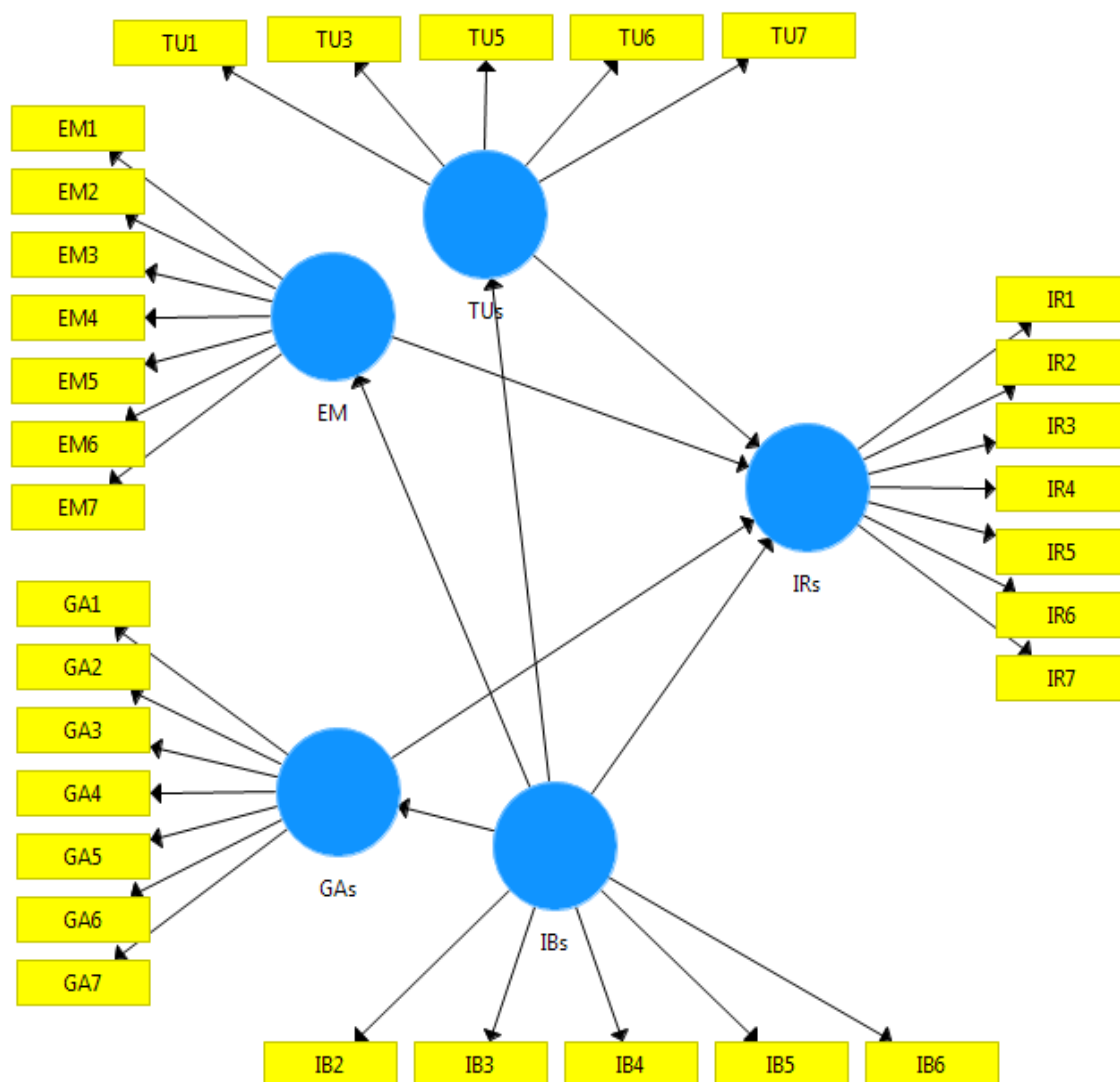

Figure 4.4: Inner Model Evaluation

Figure 4.3 shows the analysis of the measurement of the outer model. Next, this study focuses on inner model evaluation shown above in figure 4.4. According to Hair et al. (2018) the analysis of inner model can be measured by the estimations of effect size (f^2), coefficient of determination (R^2), and cross validated redundancy (Q^2).

4.7.10.1 Notion of Coefficient of Determination (R^2)

The measurement of a model's analytical accuracy is called R^2 . It is actually a joint impact of exogenous variables on the endogenous variable. The lowest effect of R^2 is 0, and the highest is 1. Hair et al. (2017) demonstrate that on endogenous variables, the R^2 values of 0.75, 0.50, and 0.25 can be considered large, moderate, and weak respectively.

4.7.10.2 Predictive Relevance (Q^2)

Q^2 represents a method for assessing the inner model's predictive relevance (Akter, Ambra, & Ray, 2011). The measure is based a sample re-use method that ignores part of the data matrix, conducts an estimation of the parameters of the model, and performs the prediction of the omitted position with the estimates. In essence, the smaller the disparity between the predicted and the original values, the larger the Q^2 and hence the predictive accuracy of the model (Akter et al., 2011). Particularly, when a Q^2 value is greater than zero for a specific endogenous construct, it indicates the predictive relevance of the path model for that specific construct. Although the comparison of a Q^2 value to zero reveals the predictability of an endogenous construct, it is silent regarding the quality of the prediction (Islam & Morgan, 2011).

4.7.10.3 Effect size (f^2)

The effect size can be calculated by following the estimation of Cohen's effect size (Cohen, 1988). If the values are 0.02, 0.15, and 0.35 respectively, the impact size is known as small, medium, and high (Meline & Wang, 2004). Hair et al. (2011) explains how to calculate the effect size in PLS. There need to be two path models: the first model includes all constructs and estimates the R^2 , and in the second model, the specific exogenous construct is removed and again the estimate of the R^2 is excluded (Hair et al., 2014). The formula to calculate f^2 is $(R^2 \text{ included} - R^2 \text{ excluded}) / (1 - R^2 \text{ included})$.

4.7.11 Multicollinearity

The latent variable is modeled in reflective models as a single predictor representing each indicator variable's value, which are the dependent variables. Consequently, multicollinearity does not constitute a serious issue in a reflective measurement model, albeit Smart PLS will produce the Variance Inflation Factor (VIF) for the measurement model, irrespective of whether it is a formative or a reflective model. Accordingly, a common rule of thumb presupposes that the existence of multicollinearity becomes problematic when VIF is greater than 5.0 (albeit some studies use a cut off value of 5.0). Basically, VIF represents the inverse of the tolerance coefficient (Hassan et al., 2015; Hair et al., 2014), and multicollinearity is identified if the tolerance level is lower than .25 (though some studies use a cut off value of .20).

4.7.12 Path Coefficient

According to Scholtz et al. (2016), after running the PLS model using the bootstrapping approach, the result provides the path-coefficient, which denotes the hypothesized relation among constructs. The path coefficient values range from -1 to +1. A value closer to +1 implies a strong positive relationship, and a strong negative relationship is closer to -1. Hair et al. (2014) suggest the minimum bootstrap sample should be 5000. They also mention that with a significance of 10%, 5% and 1%, the t values are 1.65, 1.96, and 2.58, respectively.

4.8 Data Analysis Tools

4.8.1 Statistics Package for Social Science

Statistics Package for Social Science (SPSS) version 23 was used to input the collected data and preparing for the PLS-SEM use. The expectation-maximization function was used to calculate missing data from the data set using this social science data analysis package (Graham & Sains, 2012).

4.8.2 Smart Partial Least Square 3.0

Smart PLS version 3.0 was used in this research. This is variance-based SEM software to analyze the generated hypotheses and research model. PLS path modeling software development was out dated until the year 2000, as it was developed in the mid-1960s (Monecke & Leisch, 2012). The first development of PLS-SEM was in 1980, and was called LVPLS1.8, a DOS based software. After that, PLS-graph and Visual PLS were introduced as a GUI (graphical user interface) but there has been a lack of development since it was initiated. Another statistical software R can perform PLS-SEM, but it requires a certain level of programming knowledge, which is suitable for those from a computer science background. The main reason for using Smart PLS was that the community is very strong, and several researchers have used this software to estimate their research model (Hair et al., 2016; Monecke & Leisch, 2012).

4.9 Conclusion

This chapter offered the outline of the mixed-method that was applied in this research. The population, sampling frame, sample, and sampling technique of both qualitative and quantitative approaches that appropriate for the present study explained. This study used a convenience sampling technique to measure the relationships between the actors and IRs in RMG industry of Bangladesh. Specific information about the survey instruments were discussed. The measurement of the variables was based mostly on the adoption and adaptation of previously used measurements. Finally, the researcher explained the data collection method and the measures that were taken to protect the participants. The collected data were analyzed using PLS-SEM to present the relations among the constructs of the study.

CHAPTER FIVE

SURVEY AND QUANTITATIVE DATA ANALYSIS

5.1 Introduction

This chapter presents the results of the quantitative data using the relevant statistical tools for testing the hypotheses. This chapter has 10 sections including introduction, response rate, and profile of the respondents, which has been conducted in terms of descriptive statistics. In chapter also contains the sections of common method variance based on the Harman single factor test, the descriptive statistics of the latent constructs and illustration of the measurement model respectively, and then reports predictive relevance and coefficient of determination along with the effect size. The section 5.9 provides the summary of hypothesis testing. A short summary concluding this chapter has been given in section 5.10.

5.2 Response Rate

From the reports of 17 refereed journals during 2000-2005 a total numbers of 463 different studies identified the average response rate for studies at the individual level was 52.7%, while the rate for organizational level studies was 37.2%. Moreover, the average rate shown in the 48 research publications in the industry sector is 50.30% (Baruch & Holtom, 2008). By taking considerations of the previous studies, the response rate of the present study is shown the following table 5.1.

Table 5.1: Response Rate

Method	Total Distributed Questionnaires	Returned Questionnaires	Usable Questionnaires	Unusable Questionnaires
DOPU and Web-based	600 (100%)	352 (58.67%)	327 (54.50%)	25 (4.17%)

A total of 600 questionnaires were disseminated amongst the respondents, and out of them 352 duly filled in questionnaires were collected by the researcher. From the Table 5.1 it can be seen that of the total number of questionnaires, collected only 25 questionnaires were found unusable and 327 were usable giving a response rate of 54.50%. According to Johnson and Owens (2002), there is no standard definition for a minimum acceptable response rate. Therefore, the response rate of 54.50% for the present study has been considered satisfactory.

5.3 Profile of Respondents

The profile of the respondents is given in Table 5.2 (for details see Appendix C).

Table 5.2: Descriptive Analysis of Demographic Data of the Respondents

Demographic Data	Frequency (N=327)	Percentage (%)
Gender		
Male	233	71.24%
Female	94	28.76%
Age		
20 - 30 Years old	94	28.70%
31- 40 Years old	135	41.30%
41- 50 Years old	81	24.80%
50 Years old and Above	17	5.20%
Marital Status		
Unmarried	59	18.00%
Married	268	82.0%
Education		
Below SSC	48	14.70%
Below HSC	54	16.50%
Below Bachelor	23	7.00%
Below Maters	122	37.30%
Masters and Above	80	24.50%
Employment Status		
Union Leader	111	33.90%
Factory Owner	128	39.10%
Government Representative	51	15.60%
Foreign Buyer	37	11.30%
Service Type		
Permanent	259	79.20%
Temporary	9	2.80%
Probationary	22	6.70%
Others	37	11.30%
Years for worked in RMG Industry		
Less than 2 Years	34	10.40%
More than 2 and 5 Years	34	10.40%
More than 5 and 10 Years	135	41.30%
More than 10 Years	124	37.90%
Monthly Salary		
USD 100 – USD 200	42	12.80%
USD 200 - USD 300	59	18.00%
USD 300 - USD 400	22	6.70%
USD 400 - USD 500	9	2.80%
USD 500 - USD 600	67	20.50%
USD 600 and More	128	39.10%
Firm Size		
Small Scale	20	6.12%
Medium Scale	150	45.87%
Large Scale	157	48.01%

The above table 5.2 shows that most of the respondents were male forming 71.24% of their total with females occupying 28.76% of them. Moreover, out of 111 union leaders 46% are female. The respondents also have been distributed according to their various age groups. The respondents belonging to age group of 20-30 occupies 28.70% followed by 31-40 years of 41.30% of their total. The age group of 41-50 is 24.80% and 50 and above is 5.20%.

Most respondents of this study were married forming 82.0% of their total, and the majority of the respondents forming 37.30% have the below Masters degree followed by 24.50% of Masters and above. Most of the respondents are factory owners forming 39.10% followed by 33.90% are union leaders and 15.60% and 11.30% are respectively government officials and foreign buyers. Among the respondents, 79.20% are permanent in their jobs and rests are temporary, probationary and others. The others categories belongs to the seasonal buyers.

Among the respondents, 41.30% have the work experience in RMG industry in more than 5 and 10 years where 37.90% belongs to 10 and above years. The majority respondents forming 39.1% earned monthly salary of USD 600 and more followed by 20.50% earn USD 500 - USD 600.

As per the definition of United States Small Business Administration and European Union, small and medium scale industries have the employees between 101 and 500 and annual revenues between USD 10 million to USD 1 billion (Al Mamun, 2016). 6.12% and 45.87% respondents of the present study provide their opinions who are involved with the small scale and medium industry respectively where large scale means of involvement of more than 1,000 and annual revenue more than USD 1 billion (Lignier, Evans, & Tran-Nam, 2014). This study is conducted on 48.01% of large industry.

5.4 Common Method Bias/Variance

As earlier stated in chapter 4 it was discussed that CMV are problematical because of their confusing effect on the authentic verity under examination and such biases divest the authentic or accurate clarification of observed associations between measured constructs. This study used Harman's Single Factor test based on the social research method conducted by Becker, Bryman and Ferguson, (2012). The following table 5.3 shows the results for CMV assessment of this study.

Table 5.3: Total Variance Explained

Component	Initial Eigenvalues			Extraction Sums of Squared Loadings		
	Total	% of Variance	Cumulative %	Total	% of Variance	Cumulative %
1	10.621	31.237	31.237	10.621	31.237	31.237
2	4.807	14.138	45.375			
3	2.235	6.574	51.949			
4	1.705	5.013	56.963			
5	1.397	4.108	61.070			
6	1.113	3.274	64.344			
7	1.017	2.991	67.335			
8	.840	2.470	69.805			
9	.783	2.303	72.107			
10	.687	2.022	74.129			
11	.677	1.990	76.119			
12	.591	1.737	77.856			
13	.570	1.677	79.533			
14	.511	1.503	81.036			
15	.503	1.479	82.515			
16	.473	1.391	83.906			
17	.453	1.331	85.237			
18	.439	1.292	86.529			
19	.430	1.265	87.794			
20	.401	1.180	88.975			
21	.388	1.140	90.115			
22	.366	1.075	91.190			
23	.348	1.022	92.212			
24	.322	.948	93.161			
25	.313	.921	94.082			
26	.284	.834	94.916			
27	.268	.787	95.703			
28	.254	.746	96.450			
29	.249	.731	97.181			
30	.236	.695	97.876			
31	.223	.656	98.532			
32	.191	.561	99.093			
33	.157	.462	99.555			
34	.151	.445	100.000			
Extraction Method: Principal Component Analysis						

The above table shows the un-rotated factor analysis conducted on all measurement items extracted. If the common latent factor explains more than 50% of the variance, then common method bias may be present (Eichhorn, 2014). The present study accounted for only 31.24% of the variance; thus, the common method was not a persistent dilemma in this study.

5.5 Descriptive Statistics of the Items

The following table 5.4 shows the variables of the mean and standard deviation of the study. Indicators of independent variables (TUs, employers, GAs and IBs) were measured on a 6-point Likert scale and indicators of dependent variables (IRs) were measured on an 8-point Likert scale. The mean value of the indicators of independent variables was above 3.5 and dependent variable was above 4.5. Among the 6-scale data, most of the research indicators are shown to have a mean value of more than 3.5, with the highest values for IB1 (4.79) and the lowest values for TU3 and TU7 (3.69) and among the 8-scale these were highest value IR1 (5.71) and IR7 (5.09). The mean value and the standard deviation for IR is 5.48 and 1.39 respectively.

Table 5.4: Descriptive Statistics of the indicators

	N	Minimum	Maximum	Mean	Std. Deviation
TU1	327	1	6	4.08	1.362
TU2	327	1	6	4.36	.983
TU3	327	1	6	3.69	.910
TU4	327	1	6	4.28	1.234
TU5	327	1	6	3.71	.860
TU6	327	1	6	3.78	.878
TU7	327	1	6	3.69	.869
EM1	327	2	6	4.16	.999
EM2	327	1	6	3.99	1.216
EM3	327	1	6	4.15	1.077
EM4	327	1	6	3.93	1.031
EM5	327	1	6	3.88	1.194
EM6	327	1	6	4.08	.935
EM7	327	1	6	3.86	1.090
GA1	327	1	6	4.06	.865
GA2	327	1	6	4.10	.850
GA3	327	1	6	4.16	.776
GA4	327	1	6	4.10	.715
GA5	327	1	6	4.15	.784
GA6	327	1	6	4.18	.751
GA7	327	1	6	4.41	.905
IB1	327	1	6	4.79	.989
IB2	327	1	6	4.44	.934
IB3	327	1	6	4.56	.800
IB4	327	1	6	4.55	.823
IB5	327	1	6	4.32	.945
IB6	327	1	6	4.03	.995
IR1	327	2	8	5.71	1.310
IR2	327	1	8	5.69	1.338
IR3	327	1	8	5.66	1.400
IR4	327	1	8	5.43	1.390
IR5	327	1	8	5.39	1.388
IR6	327	1	8	5.41	1.428
IR7	327	1	8	5.09	1.529
Valid N (list wise)	327				

5.6 Goodness of Measurement Model

The development of the scales to measure the variables can often be imperfect and errors due to its lack of precision. To have the accuracy in the measurement it is required to use the better instrument. The suitable instrument can enhance the scientific quality of research. To assess the accuracy of the instrument for the study, it needs to assess the goodness of the measures that the instrument measures the variables they are supposed to, and measures them accurately (Sekaran & Bougie, 2016). The help of two most important phenomena such as the reliability and validity of the measurement instrument (Bajpai & Bajpai, 2014) can judge the goodness of measurement model.

5.6.1 Convergent Validity

Convergent validity is the assessment to calculate the correlation degree of several agreed-upon measures of the same construct. The factor loading of the predictors, CR and AVE have to be considered in order to establish convergent validity (Hair et al., 2014). This study employed a cut-off point of 0.60 for loading, as recommended by Scholtz et al. (2016) and Zaid and Al-Manasra, (2013) and to get better AVE and CR. According to Hair et al. (2018), CR is suitable in the range of 0.70 to 0.95. Subsequently, the AVE of the variables was scrutinized. The AVE for the items loading on a construct, must be above the suggested value of 0.5 (Hair et al., 2011). Moreover, the measurement of all items (TUs, employers, GAs, IBs, and IRs) and variables in this study is reflective. In the appendix D, overall measurement items have been checked and shown to be highly correlated with each other within the variables.

The following table 5.5 shows that through assessing the main loading, three items were deleted, as they were loaded below 0.60 (TU2, TU4 & IB1). The AVE for each construct obtained in this was more than the recommended value 0.5 and the CR report in this study was above 0.7. The result of the study is in the range of 0.850 to 0.944 for CR and is considered significant. Therefore, this study fulfils all the criteria for convergent validity.

Table 5.5: Results of Measurement Model

Construct	Measurement Items	Loading	t-Statistics	AVE	CR
Trade Unions	TU1	0.690	14.72	0.606	0.884
	TU3	0.818	26.81		
	TU5	0.758	18.11		
	TU6	0.778	16.40		
	TU7	0.839	38.98		
Employers	EM1	0.808	34.98	0.705	0.944
	EM2	0.820	38.29		
	EM3	0.843	46.25		
	EM4	0.862	60.56		
	EM5	0.851	62.06		
	EM6	0.828	51.21		
	EM7	0.863	72.55		
Government Agents	GA1	0.679	19.58	0.504	0.876
	GA2	0.778	28.65		
	GA3	0.727	23.86		
	GA4	0.735	17.93		
	GA5	0.735	17.68		
	GA6	0.687	17.75		
	GA7	0.619	12.61		
International Buyers	IB2	0.724	17.35	0.533	0.850
	IB3	0.739	18.54		
	IB4	0.663	12.43		
	IB5	0.779	23.25		
	IB6	0.740	17.22		
Industrial Relations	IR1	0.775	29.36	0.689	0.939
	IR2	0.799	30.13		
	IR3	0.798	26.75		
	IR4	0.862	46.10		
	IR5	0.887	67.56		
	IR6	0.866	49.08		
	IR7	0.815	45.74		

5.6.2 Discriminant Validity

The discriminant validity measures how the constructs of the items differ from other constructs (Hair et al., 2017). As earlier stated in the chapter 4, in this present study, two major measures are used for discriminant validity, firstly, Fornell-Larcker criterion for assessment of the cross-loadings and secondly, heterotrait-monotrait ratio of correlations (HTMT) as a new approaches.

5.6.2.1 Fornell and Larcker Criteria

Table 5.6 shows that all the values on the diagonals were greater than the corresponding row and column values indicating the measures were discriminant. The results of the analysis show that the measurement model of this research has acceptable discriminant validity.

5.6.2.2 Heterotrit-Monotrait Ratio (HTMT)

A lack of discriminant validity is indicated by HTMT values near 1. If the HTMT value is higher than this threshold, a lack of discriminant validity may be inferred. Kline (2011) proposed a threshold of 0.85. Gold, Arvind and Malhotra (2001) also disagreed with him and suggested a value of 0.90. As shows in Table 5.5, all the values passed the recommended values. Table 5.7 demonstrates that HTMT inference also shows that the confidence interval did not show a value of 1 in any of the constructs of this study.

Table 5.6: Discriminant Validity of Constructs-Fornell-Larcker Correlation Check

Construct	EM	GAs	IBs	IRs	TUs
EM	0.839				
GAs	0.231	0.710			
IBs	0.354	0.466	0.730		
IRs	0.655	0.475	0.466	0.830	
TUs	0.145	0.477	0.301	0.406	0.778

Note: Diagonals (in bold) represent the squared root of the average variance extracted (AVE) while the other entries represent the correlations.

EM= Employer, GAs= Government Agents, IBs= International Buyers and IRs=Industrial Relations, TUs= Trade Unions.

Table 5.7: Heterotrit-Monotrait Ratio (HTMT) Criteria

Construct	EM	GAs	IBs	IRs	TUs
EM					
GAs	0.246				
IBs	0.382	0.564			
IRs	0.701	0.525	0.528		
TUs	0.202	0.571	0.370	0.448	

Note: EM=Employer, GAs= Government Agents, IBs= International Buyers and IRs=Industrial Relations, TUs= Trade Unions.

5.7 Multicollinearity

Variance Inflation Factor measures the existence of multicollinearity problems of the collected data. According to the recommendations of Hassan et al. (2015) and Hair et al. (2014) the rule of thumb multicollinearity tolerance level is less than 5.0. In this current study, there seems to be no problem concerning multicollinearity between exogenous variables since the values of the VIF are lower than 5.0. The following table 5.8 shows the results of VIF of the items of this study.

Table 5.8: Variance Inflation Factor (VIF) and Remarks

Items	VIF	Items	VIF
TU1	1.549	GA5	1.855
TU3	2.064	GA6	1.496
TU5	1.703	GA7	1.372
TU6	1.617	IB2	1.501
TU7	1.937	IB3	1.693
EM1	2.263	IB4	1.570
EM2	2.513	IB5	1.657
EM3	2.618	IB6	1.375
EM4	3.118	IR1	2.039
EM5	2.855	IR2	2.384
EM6	2.380	IR3	2.594
EM7	2.909	IR4	3.325
GA1	1.507	IR5	3.697
GA2	1.968	IR6	3.401
GA3	1.677	IR7	2.499
GA4	1.927		

5.8 Inner Model Evaluation

According to Hair et al. (2018) the analysis of inner model is done by the estimations of effect size (f^2), coefficient of determination (R^2), and cross validated redundancy (Q^2). The following figure 5.1 shows the inner model evaluation of this study.

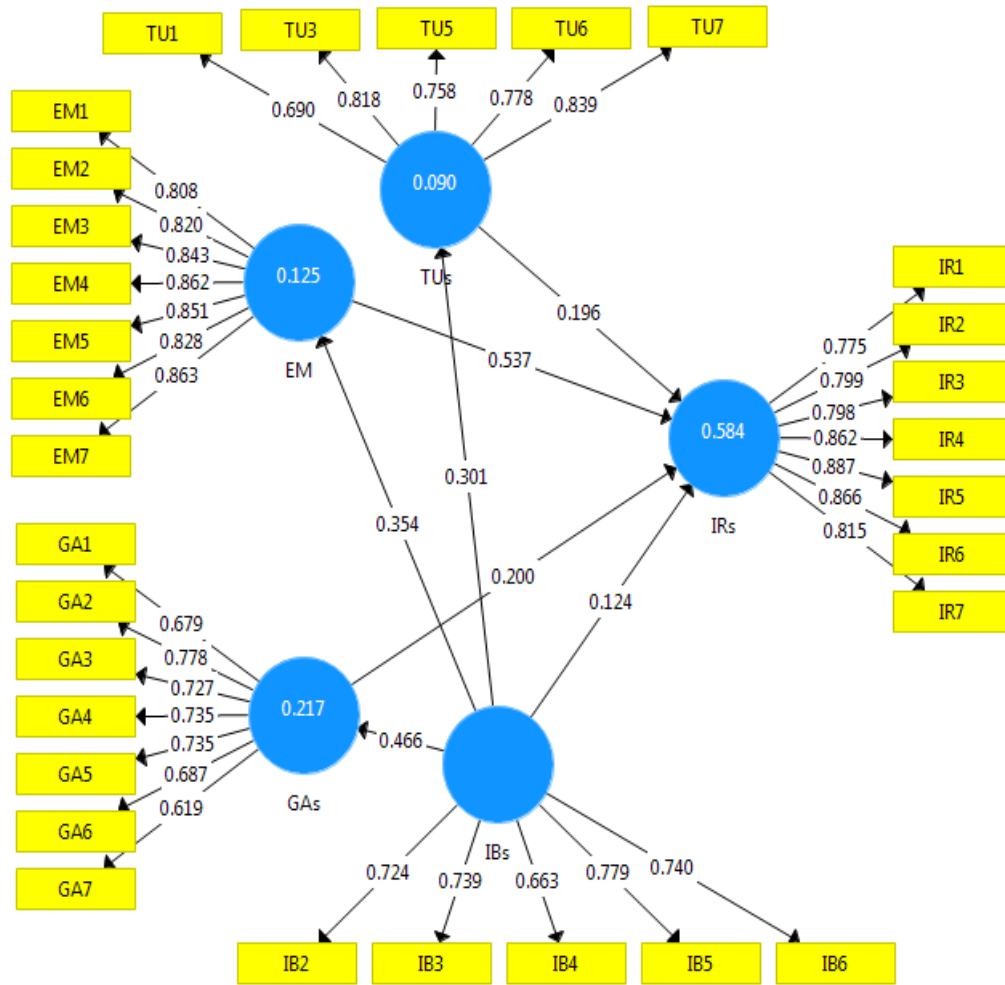

Figure 5.1: Measurement Model (n=327)

Note: TUs=Trade Unions, EM= Employers, GAs= Government Agents, IBs= International Buyers and IRs=Industrial Relations.

5.8.1 Analysis of Predictive Relevance (Q^2)

The predictive relevance that is Q^2 of a reflective model is assessed by using the tool of cross-validated redundancy. The Q^2 value is considered for the reflectively modeled endogenous factor (Geisser, 2012). The Q^2 value higher than zero tells that the exogenous constructs have predictive relevance for the endogenous constructs (Hair et al., 2011). This value is calculated by using the blindfolding algorithm omits every 7th data point for the indicators. Table 5.9, the model is considered to have predictive relevance. More specifically, the Q^2 values for EM ($Q^2=0.085$); for GAs ($Q^2=0.102$), for TUs ($Q^2=0.053$) and IRs ($Q^2=0.393$) are more than 0 suggesting that model has sufficient predictive relevance.

Table 5.9: Predictive Relevance of the Constructs (Q^2)

Constructs	$Q^2(=1-SSE/SSO)$
Employers (EM)	0.085
Government Agents (GAs)	0.102
Trade Unions (TUs)	0.053
Industrial Relations (IRs)	0.393

5.8.2 Coefficient of Determination (R^2)

In the present study, the coefficient determination shows in the following table 5.10. R^2 is actually a joint impact of exogenous variables on the endogenous variable. The lowest effect of R^2 is 0, and the highest is 1 Hair et al. (2017) demonstrate that on endogenous variables, the R^2 values of 0.75, 0.50, and 0.25 can be considered large, moderate, and weak respectively. The table 5.10 shows the R^2 values where employers (0.122), government agents (0.215), trade unions (0.088) and industrial relations (0.579). The impact of exogenous variables on the endogenous variable shows the moderate one.

Table 5.10: Coefficient of Determination (R^2)

Items	R Square
-------	----------

Employers (EM)	0.122
Government Agent (GAs)	0.215
Trade Unions (TUs)	0.088
Industrial Relation (IRs)	0.579

5.8.3 Effect Size (f^2)

The f^2 equation indicates how enormous a quantity of the unexplained variance is accounted for by R^2 change (Hair et al., 2014). The f-square values for the researcher can be illustrated by using the smart PLS. According to the Cohen (1988), there are three effects of the constructs on the model such as small effect when the value is more than .02; medium effect when the value is 0.15 and high effect when the value becomes more than 0.35. The following table is indicating the f^2 of the present study.

Table 5.11: Effect Size (f^2)

Relations	f^2	Remarks
EM→IRs	0.603	High effect
TUs→IRs	0.070	Small effect
GAs→IRs	0.063	Small effect
IBs→IRs	0.026	Small Effect
IBs→EM→IRs	0.153	Medium
IBs→GAs→IRs	0.278	Medium
IBs→TUs→IRs	0.099	Small Effect

The above table 5.11 shows employers (EM) has high effect size on industrial relations (IRs) ($f^2=0.603$) where trade unions (TUs), government agents (GAs) and international buyers (IBs) which have small effect size ($f^2=0.070$), ($f^2=0.063$) and ($f^2=0.026$) respectively on IRs. In the mediating effects of IBs on IRs through EM, GAs and TUs are respectively 0.153 (medium effect), 0.278 (medium effect) and 0.099 (small effect).

5.9 Summary of Path Coefficient and Hypothesis Testing

The results of the hypotheses are summarized in Table 5.12 shows that all hypotheses were supported. The findings from all analyses are discussed after the data analysis in the next chapter six.

Table 5.12: Summary of Hypotheses

Hypothesis	Direct Path	β	SE	t-value	p-value	Result
H1	TUs → IRs	0.196	0.049	4.007	0.000	Accepted
H2	EM → IRs	0.537	0.041	13.182	0.000	Accepted
H3	GAs → IRs	0.200	0.051	3.934	0.000	Accepted
H4	IBs → IRs	0.124	0.053	2.327	0.020	Accepted
H5	IBs → TUs → IRs	0.059	0.019	3.158	0.002	Accepted
H6	IBs → EM → IRs	0.190	0.041	4.655	0.000	Accepted
H7	IBs → GAs → IRs	0.093	0.027	3.510	0.000	Accepted

Note: $p < 0.05$, (based on Two-tailed test with 5000 bootstrapping)

EM=Employers, GAs= Government Agents, IBs= International Buyers and IRs=Industrial Relations, TUs= Trade Unions.

5.10 Conclusion

In the quantitative section, the profile of the respondents of the RMG industry of Bangladesh was presented. The collected data of this study did not have the bias threat. The model used for measurement of the items and constructs are satisfactory because the reliability, convergent validity, and discriminant validity of the indicators are adequate. Following the measurement model, the structural model was assessed to test the hypotheses of this study. The results postulate empirical evidence supporting a significant linear relationship among TUs, employers, GAs, IBs and IRs. There was found significantly relation among the independent and dependent variables of this study.

CHAPTER SIX

DISCUSSION, CONCLUSION AND FUTURE RESEARCH AGENDA

6.1 Introduction

The study was conducted to examine the influence of main actors like TUs, employers, GAs and IBs on the state of IRs in RMG sector. This chapter presents the discussions and interpretations of the results analyzed and obtained from the data based on survey. To conduct the quantitative study seven hypotheses were developed from the conceptual model of this study. The conceptual model was developed based on the literature review and qualitative field study. In the chapter five, the hypotheses were shown which were found to be showing significant positive relationships between the roles of actors and IRs in RMG industry of Bangladesh, respectively. In this chapter, the results of the hypotheses have been discussed in detail with their possible implications. This is the final chapter, which is sixth chapter presents the discussions of the findings followed by the implications, limitations, and guidelines for future study. Finally, a conclusion that condenses the entire study is presented at the end of this chapter

6.2 Findings of the Study

Based on the relevant literature and field study, seven hypotheses (H1, H2, H3, H4, H5, H6 and H7) were developed and tested. The analyses of data suggest that all seven hypotheses have been found to be strongly significant. Details of the findings are provided below.

6.2.1 Relationship between Trade Unions and Industrial Relations

The result regarding H1 shows the positive relationship between the roles of TUs and IRs. The finding indicates that the better the roles by TUs, the higher the level of IRs situations. The analysis shown in Chapter 5 (Table 5.12) confirms hypothesis H1. The TUs has a positive effect on IRs ($\beta = 0.196$, $p < 0.000$). The result of testing H1 shows the significant positive relationship between the roles of TUs and IRs such finding support by the previous researches. The finding of this study provides the evidence that the roles of TUs in respect of regulatory framework practices, working environment, organizing association, collective bargaining,

dispute resolution and buyers' CoC have been found to be associated with IRs situations in RMG industry. This finding shows that TUs is a major concern for IRs, particularly in RMG industry of Bangladesh. Budeli (2009) and Ibrahim (2013) support this actor and they find that strong and stable TUs in each industrial enterprise are essential for sound IRs.

In the context of Bangladesh, at present RMG employees are conscious about their rights and interests related with their employment (Rahman, Bhattacharya & Moazzem 2008). Siddiqui & Uddin (2016) shows that TUs helps their members in collective bargaining, consulting and awaking workers for their welfare. It also plays important roles to solve problems of their members by promoting and protecting their rights by collective actions (Blanpain, 2010; Rajesh & Manoj, 2015). For the RMG industry of Bangladesh in particular, it is logical to establish a significant relationship between TUs and IRs. In fact, TUs are concerned with ensuring that they retain their involvement during a difficult period for the sake of maintaining sound IRs in the sector under study.

6.2.2 Relationship between Employers and Industrial Relations

The test of H2 shows a strong relationship between the roles of employers and IRs. The analysis reveals that there is strong positive relationship between the roles of employers and IRs. The finding is consistent with the results of the previous studies (Simms, 2015; Snape et al., 2000; Kaium, 2020). In brief, the results indicate that employers can create a significant relationship with the actors in RMG by proper practices of regulatory frameworks, ensuring good working environment, allowing organizing association and collective bargaining and following the buyers' CoC that can generate sound IRs in the sector. The analyzed data indicates that the roles of employers ($\beta = 0.537$, $p < 0.000$), positively influence IRs situation which means H2 is significantly accepted.

Previous researches by Oluoch (2013), Gupta, Bostrom & Huber (2001) and Aguinis & Kraiger (2009) reported that the employers' roles can influence the organizational performance. In the RMG industry proper remuneration, pleasant co-worker relationship with good working conditions ensured by the employers play an important role in creating sound IRs (Kaium, 2020). The collective roles of employers in this regard can lead to attain desired development (Gibb & Ishaq, 2020).

The previous literature on IRs in RMG industry of Bangladesh suggests that developing better work teams by ensuring compliance to labor standards by the employers can facilitate the maintenance of sound IRs in the sector. Moreover, the establishment of compliance department by the factory owners according to the guidance of the IBs is considered a positive effort in improving working conditions in RMG sector.

Again, it can be stated that proper roles by the employers in the RMG industry of Bangladesh is considered to be a most significant one which serves the sectors to ensure the working environment and living standards of the workers and bring about the subsequent improvement in IRs.

6.2.3 Relationship between Government Agents and Industrial Relations

The third hypothesis of this study is concerned with bringing out the nature of relationship between GAs and IRs in the RMG industry in Bangladesh. The analysis shows the positive relation between GAs and IRs, which is also supported by previous studies conducted by Abun et al. (2018) and Hossain & Arefin (2015). From the chapter 5 (Table 5.12), the result of hypothesis H3 exhibits that that GAs ($\beta = 0.200$, $p < 0.000$) has a significantly positive relations with IRs of RMG industry. Therefore, IRs of RMG industry of Bangladesh is being positively influenced by the roles of government and its agents. Moreover, GAs is interested in playing their roles according to the BLA 2006 that facilitates harmonious relationship among the actors of IRs in the identical sector. The supports provided by the GAs to the TUs, employers, IBs are creating a positive attitude towards them.

The government agent as being one of the important actors in IRs in the RMG industry of Bangladesh is playing effective role in mediating and settling industrial disputes in the sector under study (Islam & Asaduzzaman 2015). This study found that some initiatives by the GAs are keeping significant impact on the IRs because of introducing a 4-week training on IRs related courses such as labor law, labor administration and its functions, various labor conventions and issues regarding domestic, international IRs courses, etc (DoL, 2020).

The government agents also provide one-week training courses (DoL, 2020) to the actors regarding the workers' rights and responsibilities, productivity, OHS issues maintained by the employers in their factories according to the CoC prescribed by the IBs. The qualitative field study reveals that there is a positive relationship between GAs and IRs in the RMG industry in Bangladesh, and it has been made possible due to the distribution of free medical services and medicines to workers and their families. It also provides the advice to the employees and employers to improve the living standards, particularly of the workers in the sector.

6.2.4 Relationship between International Buyers and Industrial Relations

The fourth hypothesis revealing the relationships between IBs and IRs has been tested in four dimensions shown in the chapter 3. Firstly, IBs and IRs are directly and positively correlated. The second dimension revealing the type of relationship between IBs and IRs amidst the mediating roles of TUs, the third dimension revealing the type of relationship between IBs and IRs amidst the mediating roles of employers and the fourth one revealing the type of relationship between IBs and IRs amidst the mediating roles of the GAs have also shown that there exist a significant positive relationships between IBs and IRs. The results of testing H4 presents that Beta (β) is 0.124 with the t value of 2.327 where the p value is 0.020 at 95% level of significance. Previous researches done by Absar (2012) and Alam et al. (2017) have the same result where they found that there is a significant relationship between the IBs and IRs.

The results of the fifth, sixth and seventh hypotheses show the relationships of IBs with the IRs from the viewpoint of mediating roles of TUs, employers and GAs. The testing results amidst the mediating effects of TUs explain the relationships between IBs and IRs in RMG industry in Bangladesh shown in the table 5.12, which is Beta (β) 0.059 with the t value of 3.158 where the p value is 0.002, indicating that there is a significant positive relationship between IBs and IRs. Again, it has been found that the beta value of 0.190 with t-value of 4.655 also indicate that the significant positive relationship between IBs and IRs are existing amidst mediating roles of employers. The beta value of 0.093 with t-value of 3.510 and p value of 0.000 indicate that there exists a positive relationship between the IBs and IRs amidst the intervening roles of GAs.

The previous study argues that IBs are putting increasingly more importance on IRs issues in industries of the importing countries directly or through the TUs, employers and GAs who are becoming more concerned about the work and social environment in sourcing out their activates to the factories in Bangladesh (Samaddar, 2016). Considering the IRs in the RMG industry of Bangladesh, several and diverse national and international commitments and initiatives resulted in as part of the reform and restructuring of the RMG sector aiming at improvement of workplace safety to safe-guard the lives of more than four million RMG employees, and to retain the confidence in IBs (Ansary & Barua, 2015). Alam et al. (2018) reiterated that most of the IBs now are directly implementing and maintaining their CoC during placing their work orders or indirectly through the TUs, employers, and GAs, which leads to maintaining a sound IRs.

Previous studies also argued that IBs as a crucial actor of RMG industry can put more pressure for a healthy and positive IRs. Accord on Fire and Building Safety and Alliances for Bangladesh Workers Safety – these two alliances of IBs have also significant effect on the RMG sector of Bangladesh which creates sound IRs, thereby growing green RMG industry for the betterment and interests of the TUs, employers, GAs (Hasan, 2018). The result of the present study shows that the roles of IBs are very important for establishing and maintaining sound IRs.

6.3 Implications of the Study

This section discusses the theoretical and practical implications based on the findings in this research. This study has identified the actors of IRs in the RMG industry of Bangladesh. It also strives to measure the types of relationships between the actors and IRs. The study finds the significant positive relationships between the actors and IRs. The following section gives some information about the research implications.

6.3.1 Theoretical Implications

As stated earlier, a number of varied actors play significant roles in RMG industry of Bangladesh but previous studies did not make any panoptic focus on the roles of specific actors in IRs in RMG industry of Bangladesh. This study has been conducted to have a better understanding of the IRs in RMG industry in Bangladesh. It is also stated earlier

that in the existing literature there was a lack of well-accepted theoretical framework to study on IRs in RMG industry in Bangladesh. This study contributes to the literature and theory of IRs particularly in the RMG sector of Bangladesh. It contributes to the theory of IRs by integrating the strategic choice theory.

In 1958, John Dunlop developed a model for industrial relations system (figure 3.1) where three actors were considered, they are TUs, employers and GAs. This study developed a conceptual research model by adding another actor to IRs model originally propounded by John Dunlop (figure 3.2) based on literature reviews and qualitative study. The researcher during the literature review has identified the roles of IBs and then conducted an in-depth interviews with a panel of experts to confirm the another actor to be added to IRs model. Further, the conceptual research model was assessed by using an empirical data set linking observations of the actors involved with IRs in RMG of Bangladesh regarding the roles of IBs and employers and GAs. Thus, this study tends to contribute to the new issues as to how IBs are playing their roles in determining desired IRs situations in the RMG industry in Bangladesh besides having influence on other actors of IRs, which the previous the research works lack.

Moreover, most of the previous works have attempted to address the issues relating to problems and prospects of RMG industry, IRs situation, incidents of RMG industries of Bangladesh, the roles of TUs and governance in the RMG industry with having focus mostly on the present scenarios of RMG. Therefore, the theoretical contribution of this study is completely new because, firstly, it investigated the roles of actors of IRs in RMG in Bangladesh. Secondly, it added another actor of IRs to the existing model developed by John Dunlop. Thirdly, it integrated well-accepted strategic choice theory in the field of IRs. Fourthly, it focused on to the context of a developing nation like Bangladesh and finally, it measured the types of direct and mediating relationships between the actors and IRs in the sector under study.

6.3.2 Practical Implications

The outcome of the study will have important policy impact on the RMG industry in Bangladesh and issues related to IRs. As the study has identified the influential actors involved and examined their roles resulting in a state of IRs in RMG industry in Bangladesh. The outcome of the study is useful to various stakeholders involved with maintaining a pattern of IRs in RMG sector for creating a positive image, which can help to boost far better relationships among them. Al Faruque (2009) claimed in his study that the TUs and the GAs in the RMG industry in Bangladesh were remaining defunct. The findings of this study attempts to nullify that claim and it has been found that the TUs and the GAs in the sector under study are very much functional. The findings of the study will encourage the stakeholders of the sector towards putting their trust in the roles of TUs and GAs, and consequently, the stakeholders involved will come forward to establish the rights of workers, make workers aware of their rights, ensure collective bargaining and labor welfare, and maintain better employer-employee relations.

Further, this study also evidences that there exists solid relationship between the actors helping maintain a sound IRs in the industry. Finally, the study will allow the actors involved to undertake steps for achieving preparedness in future for ensuring IRs and thereby making a harmonious working place for all. Moreover, this study will be helpful for IRs academics and practitioners particularly not only in Bangladesh but throughout the world.

6.4 Recommendations

In order to ensure a sound IRs in the RMG industry of Bangladesh a number of issues and initiatives have to be taken both at policy formulation and execution levels. The following recommendations have been proposed for maintain a sound IRs in RMG industry based on the findings.

- a. The RMG sector in Bangladesh is influenced and taken care of by various authorities having no specific regulation with a single authority put in charge of the sector. This sector should have separate ministry so that policy decision could be taken quickly to help this sector cope up with the changing scenario the world and to cater to the needs of the fourth industrial revolution.

- b. The management of the sector has to be made sophisticated with the inclusion of sound management system, giving priority to the domestic meritorious job applicants to replace foreign nationals in the name of maintaining experts who are dominating the sector at present even by going against the interest of the sector by destabilizing tranquility in the sector.
- c. With proper initiatives like providing training to local employees, government can retain more foreign currency and create employment opportunities for the talented locals.
- d. Owners of the companies should have a proper and functional human resource system to sustain the business. Reducing the dependency on other countries for materials is vital to make the supply chain strong. Without proper management in supply chain, only minimum wage competitiveness cannot ensure sustainable business. Therefore, for the sake of the industry, Bangladesh has no alternative except for making an effective supply chain management.
- e. Workers Participation Committee in the RMG units can serve as an effective body for bridging gap between the employers and the employees. For ensuring the proper functioning of WPC, providing guarantee in application of labor laws, encouraging vocational training, workers education and family welfare training are most important. The WPC can work as a forum ensures that the employee's legal right is met by the employers.
- f. Maintaining compliance according to the buyers' prescription is very expensive. There is a huge gap between prices offered by the buyers for RMGs and the costs for executing compliances according to their prescriptions. The government may arrange for easy or interest free loans for the owners of the factory to help them maintain the compliances properly.
- g. There should be a strong and effective punitive measure against anti-union activity and for not complying with required safety standards.

- h. Programs should be designed and launched to educate garment factory owners about the constructive role of TUs in RMG industries and to ensure that anti-union activity is eradicated.
- i. The actors, in collaboration with the ILO and representative of unions, should sponsor a program to educate RMG employees about their rights and responsibilities related to freedom of association, collective bargaining etc. Union leaders perceived the functioning of the union as highly successful, whereas managers and workers did not agree with their opinions. To change the attitudes of the managers toward workers' perception the TUs should try to dispel the mistrust and lack of faith in them. The employees and the TUs also should develop a sense of ownership for creating congenial IRs.
- j. The government can take initiative to set up skill development centers for the workers in RMG sector. This will help a large portion of the unemployed population to get employment, industry will get efficient workforce also.
- k. The apex body of BGMEA can introduce frequency modulation (FM) radio for the RMG sector as the source of entertainment and information. This radio can improve employee-employer relationship.
- l. Moreover, after 40 years the employees lost their working ability because of their poor nutrition and long time working. This should be taken care of properly.

6.5 Limitations of the Study

The first limitation of this study is the sampling method used, where random sampling was not used. It is explained in the methodology earlier in the chapter 4 that data collection from the RMG sector was very difficult. In this regard, the researcher faced difficulties conducting the quantitative data collection activity using random sampling techniques. Moreover, in the survey, the RMG in Dhaka City or nearby Gazipur, Ashulia, Baipail were all selected purposively or where access was easier. However, the RMG industries of other areas of the country like Narayanganj or Chittagong were excluded from this study. Another important limitation was that the study was done based on the BGMEA list embodying 100% export oriented factories and which also fall into the category of

factories following compliance properly. The study should have covered non-compliance and local market manufacturing RMG to get the overall picture regarding the IRs in RMG of Bangladesh. The conclusions reached in the study may not have universal application.

This study did not include the WPC's roles and their implications for the form of IRs in the RMG industry in Bangladesh. The developed conceptual model embodying fourth actor and the interpretations thereof are industry specific, particularly for the RMG industry in Bangladesh. The results of this study might not explain the same problem from a different perspective even in the same industry in a different economy. This study did not measure the reciprocal relationships among the actors relating to IRs in the industry under study.

6.6 Further Research Agenda

The limitations, which described above is the source of guidelines for further research in IRs. Such as the future research can be conducted to measure the reciprocal relationships among the actors relating to IRs. Future researchers may develop a more country specific model by adding IBs to the existing model given by John Dunlop (1958) for a similar industry. Accordingly, this process might be helpful one in making this model universally accepted. Further research may consider the WPC as the respondents group to measure the IRs situations in RMG industry in Bangladesh. The next researchers may consider the wide area of the sector to get an overall picture of the industry based on the study of the compliance and non-compliance factories in the sector. Last but not least, in the future, cross cultural study of IRs may be conducted.

6.7 Conclusion

Bangladesh has become a hub for the RMG manufacturing industry. The contribution of this sector is huge in export earnings and employment generation. This sector not only generates employment but also helped develop a class of entrepreneurs over the period. Therefore, the RMG industry has a special role in the economy of Bangladesh. IRs means the relationships among the actors. Four actors TUs, employers. GAs and IBs are involved in this RMG sector in Bangladesh and their sound relation is very important for its sound and smooth and productive operations.

This study attempts to identify the specific roles of the actors and measure their roles association with the present state of IRs in RMG industry in Bangladesh. A conceptual framework model has been constructed to elucidate the roles of actors determining the IRs in RMG industry, within the framework of which the strategic choice theory has been used to measure the actor's roles influencing IRs. This research is based on the model incorporating four actors like TUs, employers, GAs and IBs including their roles they play being influenced by six dimensional practices (such as regulatory framework practices, working environment, organizing association, collective bargaining, dispute resolution and buyers' codes of conduct). The analysis of the data shows that there are significant relationships between the roles of the actors and the state of IRs in the RMG industry in Bangladesh. The relationships in question were found to be same even amidst mediating role of the IBs with rest of the actors.

Bangladesh has set itself the target of achieving USD 50 billion in apparel exports by 2021 and it seems to be on the right path. To attain this target in the years to come more than 4.7 thousands garments factories will be engaged in Bangladesh. Bangladesh plans to achieve the country's middle-income status by 2021 in where the RMG sector will play a significant role. To fulfill these targets by the roles of RMG industry, it needs to have congenial relationships among the actors of IRs. The government of Bangladesh and the BGMEA, in coordination with the ILO, should undertake more programs to aware and promotes the employers, employees, TU leaders and IBs on the constructive role in RMG to ensure a sound IRs.

BIBLIOGRAPHY

- Abbott, K. (2006). A review of employment relations theories and their application. *Problems and Perspectives in Management*, 1(1), 187-199.
- Abdullah, A. R., & Islam, A. (2018). The Level of Knowledge, Attitude and Behavior towards Sustainable Development among the Employees of Readymade Garments (RMG) Industry in Chittagong, Bangladesh. *PERSPECTIVES IN ORGANIZATIONAL BEHAVIOUR*, Penerbit Universiti Putra Malaysia.
- Abernathy, F. H., Volpe, A., & Weil, D. (2004). *The apparel and textile industries after 2005: Prospects and choices*. Cambridge, MA: Harvard Center for Textile and Apparel Research.
- Abernathy, F. H., Volpe, A., & Weil, D. (2006). The future of the apparel and textile industries: prospects and choices for public and private actors. *Environment and Planning A*, 38(12), 2207-2232.
- Absar, M. M. N. (2012). Industrial relations in Bangladesh: a comparative scenario between public & private sectors. *Indian Journal of Industrial Relations*, 19-27.
- Abu, Zailinawati, H. (2006). Doing a pilot study: Why is it essential? *Academy of Family Physicians of Malaysia*, 1(2), 70-73.
- Abun, D., Magallanes, T., Agoot, F., & Benedict, S. (2018). MEASURING WORKPLACE RELATIONSHIP AND JOB SATISFACTION OF DIVINE WORD COLLEGES'EMPLOYEES IN ILOCOS REGION, *International Journal of Current Research*, 10 (11), 75279-75286.
- Ackers, P. (2005). *Collective bargaining as industrial democracy: Hugh Clegg and the political foundations of British Industrial Relations pluralism*. Loughborough University.
- Ackers, P. (2007). Collective bargaining as industrial democracy: Hugh Clegg and the political foundations of British industrial relations pluralism. *British Journal of Industrial Relations*, 45(1), 77-101.
- Ackers, P. (2010). An industrial relations perspective on employee participation. In *The Oxford Handbook of Participation in Organizations*.
- Ackers, P. (2014). Rethinking the employment relationship: a neo-pluralist critique of British industrial relations orthodoxy. *The International Journal of Human Resource Management*, 25(18), 2608-2625.

- Ackers, P. (2015). Trade unions as professional associations. *Finding a voice at work*, 95-126.
- Ackers, P., & Wilkinson, A. (Eds.). (2003). *Understanding work and employment: Industrial relations in transition*. Oxford University Press on Demand.
- Acock, A. C. (2005). Working with missing values. *Journal of Marriage and family*, 67(4), 1012-1028.
- Adams, R. J. (1992). The role of the state in industrial relations. *Research frontiers in industrial relations and human resources*, 489-521.
- Adewale, A. R. (2017). Import Substitution Industrialisation and Economic Growth—Evidence from the group of BRICS countries. *Future Business Journal*, 3(2), 138-158.
- Adler, P. S. (2007). The future of critical management studies: A paleo-Marxist critique of labour process theory. *Organization Studies*, 28(9), 1313-1345.
- Adler-Milstein, S., Champagne, J., & Haas, T. (2013). The right to organize, living wage, and real change for garment workers. *Lessons for social change in the global economy: Voices from the field*.
- Adnan, A. T. M., Khan, A. N., & Islam, M. S. (2019). Competitive Position of Bangladesh and China in the Global Clothing Export Market: An Analysis of Revealed Comparative Advantage. *Trends Economics and Management*, 13(34), 9-28.
- Adnan, A. T. M., Rakib, A., & Rahman, M. (2015). Export trend of Bangladesh: The dominance of ready-made garment industry. *Research Journal of Economics, Business and ICT*, 10(1).
- Afrin, S. (2014). Labour Condition in the Apparel Industry of Bangladesh: Is Bangladesh Labour Law 2006 Enough?. *Development Country Studies*, 4(11).
- Aguinis, H., & Kraiger, K. (2009). Benefits of training and development for individuals and teams, organizations, and society. *Annual review of psychology*, 60, 451-474.
- Aguirre-Urreta, M. I., Marakas, G. M., & Ellis, M. E. (2013). Measurement of composite reliability in research using partial least squares: some issues and an alternative approach. *ACM SIGMIS Database: the DATABASE for Advances in Information Systems*, 44(4), 11-43.
- Ahad, N. A., Yin, T. S., Othman, A. R., & Yaacob, C. R. (2011). Sensitivity of normality tests to non-normal data. *SainsMalaysiana*, 40(6), 637-641.
- Ahamed, F. (2011). Working conditions in the Bangladesh Readymade Garments Industry: Is Social compliance making a difference. *Unpublished Ph. D Thesis, La Trobe University, Australia*.

- Ahamed, F. (2012). Can trade unions play an effective role in defending workers' rights in the Bangladesh ready-made garment industry?. *Middle East Journal of Business*, 55(189), 1-5.
- Ahamed, F. (2013). Background of History of Bangladesh and Ready-made Garment Industry: Key challenges in the RMG Industry. *Middle East Journal of Business*, 8(1).
- Ahamed, F. (2013). Could monitoring and surveillance be useful to establish social compliance in the ready-made garment (RMG) industry of Bangladesh? *International Journal of Management and Business Studies*, 3(3), 88-100.
- Ahammad, T., Shanta, F., Hossain, M. M., & Naim, M. J. (2017). Trade Unions and Industrial Relations in Bangladesh: Human Resource Aspect. *International Journal of Latest Engineering and Management Research (IJLEMR)*, 2(10), 1-7.
- Ahlquist, J. S., & Mosley, L. (2020). Firm participation in voluntary regulatory initiatives: The Accord, Alliance, and US garment importers from Bangladesh. *The Review of International Organizations*, 1-27.
- Ahmed, J. U., & Hossain, T. (2009). Industrial safety in the readymade garment sector: A developing country perspective. *Sri Lankan Journal of Management*, 14(1), 1-13.
- Ahmed, N. (2009). Sustaining ready-made garment exports from Bangladesh. *Journal of Contemporary Asia*, 39(4), 597-618.
- Ahmed, N., & Nathan, D. (2016). Improving wages and working conditions in the Bangladesh garment sector. *Labour in global value chains in Asia*, 51-77.
- Ahmed, S., & Raihan, M. Z. (2014). Health status of the female workers in the garment sector of Bangladesh. *J Faculty EconomAdministrSci*, 4(1), 43-58.
- Ahmed, S., Raihan, M., & Islam, N. (2013). Labor unrest in the readymade garment industry of Bangladesh. *International Journal of Business and Management*, 8(15).
- Aigbavboa, C., & Thwala, W. (2013). A Theoretical Framework of Users' Satisfaction / Dissatisfaction Theories and Models. *2nd International Conference on Arts, Behavioral Science and Economics Issues*, 17-18.
- Akhter, S. (2014). Deming management method in the readymade garments industry of Bangladesh. *Journal of Management*, 9(1), 178-189.
- Akhter, S., Rutherford, S., Kumkum, F. A., Bromwich, D., Anwar, I., Rahman, A., & Chu, C. (2017). Work, gender roles, and health: neglected mental health issues among female workers in the ready-made garment industry in Bangladesh. *International journal of women's health*, 9, 571.

- Akhter, S., Salahuddin, A. F. M., Iqbal, M., Malek, A. B. M. A., & Jahan, N. (2019). Health and occupational safety for female workforce of garment industries in Bangladesh. *Journal of Mechanical Engineering*, 41(1), 65-70.
- Akintayo, D. (2012). Working environment, workers' morale and perceived productivity in industrial organizations in Nigeria. *Education Research Journal*, 2(3), 87-93.
- Akinyele, S. T. (2010). The influence of work environment on workers productivity: A case of selected oil and gas industry in Lagos, Nigeria. *African Journal of Business Management*, 4(3), 299-307.
- Akter, S., D'Ambra, J., & Ray, P. (2011). An evaluation of PLS based complex models : the roles of power analysis , predictive relevance and GoF index. In *AMCIS2011* (pp. 1-7).
- Akterujjaman, S. M. (2013). Export Performance of Readymade Garments Sector of Bangladesh: An Analysis. Available at SSRN 2642828.
- Al Faruque, A. (2009). *Current status and evolution of industrial relations system in Bangladesh*. International Labour Organization.
- Al Mamun, A. (2016). Constraints for Bangladeshi RMG Factories to be Compliant. *International Journal of Innovative Science and Modern Engineering*, 4(2), 13-18.
- Alam, M. J., Mamun, M. Z., & Islam, N. (2004). Workplace Security of Female Garments Workers in Bangladesh. *Social science review*, 21(2), 191-200.
- Alam, M. N., Alias, R. B., & Azim, M. T. (2018). Social Compliance Factors (SCF) Affecting Employee Productivity (EP): An Empirical Study on RMG Industry in Bangladesh. *Pac. Bus. Rev. Int*, 10, 87-96.
- Alam, M. N., Azim, M. T., & Alias, R. B. (2017). Social compliance in ready-made garment industry in Bangladesh: Challenges for HR personnel. *Journal of Applied Environmental and Biological Science*, 7(10), 8-18.
- Alam, M. S., Selvanathan, E. A., & Selvanathan, S. (2017). Determinants of the Bangladesh garment exports in the post-MFA environment. *Journal of the Asia Pacific Economy*, 22(2), 330-352.
- Alamgir, F., & Banerjee, S. B. (2019). Contested compliance regimes in global production networks: Insights from the Bangladesh garment industry. *Human Relations*, 72(2), 272-297.

- Al-Amin, M., & Hoque, M. M. (2015). Violence against Women Workers in the Ready-made Garments Industry in Bangladesh. *World Vision*, 9(1).
- Ali, A. Y. S., Ali, A. A., & Adan, A. A. (2013). Working conditions and employees' productivity in manufacturing companies in sub-Saharan African context: Case of Somalia. *Educational Research International*, 2(2), 67-78.
- Ali, F., Kim, W. G., & Ryu, K. (2016). The effect of physical environment on passenger delight and satisfaction: Moderating effect of national identity. *Tourism Management*, 57, 213-224.
- Allen, M. M. (2016). Employer and Worker Collective Action: A Comparative Study of Germany, South Africa, and the United States.
- Allison, P. D. (2001). *Missing data* (Vol. 136). Sage publications.
- Allred, S. B., & Ross-Davis, A. (2011). The drop-off and pick-up method: An approach to reduce nonresponse bias in natural resource surveys. *Small-Scale Forestry*, 10(3), 305-318.
- Andati, R. O., & Otuya, D. (2019). A Critical Review of Literature on Labour Relations and Employee Performance in Kenya after the Promulgation of the 2010 Constitution. *A Critical Review of Literature on Labour Relations and Employee Performance in Kenya after the Promulgation of the 2010 Constitution (December 26, 2020)*. *American Based Research Journal*, 8(12).
- Anderson, J. C., & Gerbing, D. W. (1988). Structural equation modeling in practice: A review and recommended two-step approach. *Psychological bulletin*, 103(3), 411.
- Andrias, K. (2016). The New Labor Law. *Yale LJ*, 126, 2.
- Angle, H. L., & Perry, J. L. (1986). Dual commitment and labor-management relationship climates. *Academy of Management Journal*, 29(1), 31-50.
- Anner, M. (2020). Squeezing workers' rights in global supply chains: purchasing practices in the Bangladesh garment export sector in comparative perspective. *Review of International Political Economy*, 27(2), 320-347.
- Ansary, M. A., & Barua, U. (2015). Workplace safety compliance of RMG industry in Bangladesh: Structural assessment of RMG factory buildings. *International Journal of Disaster Risk Reduction*, 14, 424-437.
- Antras, P. (2015). *Global production: Firms, contracts, and trade structure*. Princeton University Press.
- Anyim, F. C., Ikemefuna, C. O., & Ekwoaba, J. O. (2012). Dunlopian theory: Impact and relevance to Nigeria industrial relations system. *International Journals of Business and Management Studies*, 2(2), 039-046.

- Appelbaum, R. P., & Gereffi, G. (1994). Power and profits in the apparel commodity chain. *Global production: The apparel industry in the Pacific Rim*, 42-62.
- Argyrou, K. (2014). Exploring the logistics sector in Bangladesh: opportunities, threats and practical information.
- Arkkelin, D. (2014). Using SPSS to understand research and data analysis.
- Armbruster-Sandoval, R. (2005). *Globalization and cross-border labor solidarity in the Americas: The anti-sweatshop movement and the struggle for social justice*. Routledge.
- Arrfelt, M., Wiseman, R. M., McNamara, G., & Hult, G. T. M. (2015). Examining a key corporate role: The influence of capital allocation competency on business unit performance. *Strategic Management Journal*, 36(7), 1017-1034.
- Arthur, J. B. (1992). The link between business strategy and industrial relations systems in American steel minimills. *ILR Review*, 45(3), 488-506.
- Arumugam, S., & Balasundaram, N. (2010). Industrial Relation System: Lessons for Bangladesh and Sri Lanka from Japanese Perspective. *Petroleum-Gas University of Ploiesti Bulletin, Economic Sciences Series*, 62(1).
- Ashwin, S., & Clarke, S. (2002). *Russian trade unions and industrial relations in transition*. Springer.
- Attfield, R. (2014). *Environmental ethics: An overview for the twenty-first century*. John Wiley & Sons.
- Atzeni, M. (2010). *Workplace conflict: mobilization and solidarity in Argentina*. Springer.
- Awan, A. G., & Tahir, M. T. (2015). Impact of working environment on employee's productivity: A case study of Banks and Insurance Companies in Pakistan. *European Journal of Business and Management*, 7(1), 329-345.
- Azad, M. T. A., Hasan, I., Saha, M. K., Ahmmed, R., Moni, S. J., & Kabir, M. H. (2019). Risk of Fire Disaster: Consequences on Industry Sectors in Bangladesh.
- Azam, J. P., & Salmon, C. (2004). Strikes and political activism of trade unions: Theory and application to Bangladesh. *Public Choice*, 119(3-4), 311-334.
- Azim, M. T., Alam, M. N., & Alias, R. B. (2017). Social compliance in ready-made garment industry in Bangladesh: Challenges for HR personnel. *Journal of Applied Environmental and Biological Science*, 7(10), 8-18.
- Azizah, A. (2011). *Business intelligence for sustainable competitive advantage: the case of telecommunications companies in Malaysia* (Doctoral dissertation, Curtin University).

- Babin, B. J., Hair, J. F., & Boles, J. S. (2008). Publishing research in marketing journals using structural equation modeling. *Journal of marketing theory and practice*, 16(4), 279-286.
- Bacharach, S. B., & Lawler, E. J. (1981). *Bargaining: Power, Tactics and Outcomes*. Jossey-Bass Inc., 433 California Street, San Francisco, CA 94104.
- Backhaus, K. B., Stone, B. A., & Heiner, K. (2002). Exploring the relationship between corporate social performance and employer attractiveness. *Business & Society*, 41(3), 292-318.
- Bacon, N., & Blyton, P. (2004). TU responses to workplace restructuring: exploring union orientations and actions. *Work, Employment and Society*, 18(4), 749-773.
- Badejo, A. E. (2011). A Critique of the Role of the State in Industrial Relations in Nigeria. In *A paper presented at the International Labour Organization Regional Congress held in Lagos*.
- Bagozzi, R. P. (1994). Structural equation models in marketing research: Basic principles. *Principles of marketing research*, 3(1), 7-385.
- Bagozzi, R. P., & Yi, Y. (1988). On the evaluation of structural equation models. *Journal of the Academy of Marketing Science*, 16(1), 74-94.
- Bain, G. S., & Clegg, H. A. (1974). A strategy for industrial relations research in Great Britain. *British Journal of Industrial Relations*, 12(1), 91-113.
- Bain, J. S. (1968). *Industrial Organization*. John Willey & Sons. Inc. New York, 12-44.
- Bajpai, S., & Bajpai, R. (2014). Goodness of measurement: Reliability and validity. *International Journal of Medical Science and Public Health*, 3(2), 112-115.
- Bakhshi, A., Kumar, K., & Rani, E. (2009). Organizational justice perceptions as predictor of job satisfaction and organization commitment. *International journal of Business and Management*, 4(9), 145-154.
- Bakht, Z., & Hossain, M. (2017). Workplace safety and industrial relations in the readymade garments (RMG) industry in Bangladesh.
- Baldwin, R., Cave, M., & Lodge, M. (2012). *Understanding regulation: theory, strategy, and practice*. Oxford University Press on Demand.
- Bancerz, M. (2016). New CSR in the food system : Industry and non- traditional corporate food interests. *Canadian Food Studies*, 3(2), 127-144.
- Bangladesh Garment Manufacturers and Exporters Association (2019). About Garment Industry of Bangladesh.
<https://www.bgmea.com.bd/home/about/AboutGarmentsIndustry>.

- Bangladesh Institute of Labour Studies (2016). State of Bangladesh' s RMG Sector Tripartism and the Scope of Harmonious Industrial and Labour Relations,<http://bilsbd.org/wp-content/uploads/2016/03/State-Of-Bangladesh-Rmg-Sector-Tripartism-And-The-Scope-Of-Harmonious-Industrial-And-Labour-Relations.pdf>
- Bangladesh Institute of Labour Studies (2017). *Employment Security Wage and Trade Union Rights*,<http://bilsbd.org/wp-content/uploads/2017/03/Employment-Security-Wage-and-Trade-Union-Rights-in-Four-Industrial-Sectors.pdf>.
- Bangladesh Institute of Labour Studies (2018). *Workers Rights & Gender Based Violence in the RMG and TU capacity to Deal with These*,<http://bilsbd.org/wp-content/uploads/2018/01/Workers-Rights-Gender-Based-Violence-in-the-RMG-and-TU-Capacity-to-Deal-with-These-Final-Draft.pdf>.
- Bangladesh Institute of Labour Studies Report, 2019, <http://bilsbd.org/research-report/>
- Bangladesh Knitwear Manufacturers and Exporters Association (2019). AFTER RANA PLAZA, <https://bkmea.com/categories/working-paper-series/>. Bangladesh Labor Act, 2006.
- Barling, J., Fullagar, C., & Kelloway, K. K. (1992). *The union and its members: A psychological approach*. Oxford University Press.
- Barry, M., & Wilkinson, A. (2011). Reconceptualising employer associations under evolving employment relations: countervailing power revisited. *Work, employment and society*, 25(1), 149-162.
- Barua S., Kar D., & Mahbub FB (2018). Risks and their management in ready-made garment industry: Evidence from the world's second largest exporting nation. *Journal of Business and Management*, 24(2), 75-99.
- Baruch, Y., & Holtom, B. C. (2008). Survey response rate levels and trends in organizational research. *Human relations*, 61(8), 1139-1160.
- Batt, R., Nohara, H., & Kwon, H. (2010). Employer strategies and wages in new service activities: a comparison of coordinated and liberal market economies. *British Journal of Industrial Relations*, 48(2), 400-435.
- Baumann-Pauly, D., Labowitz, S., & Banerjee, N. (2015). Closing Governance Gaps in Bangladesh's Garment Industry—The Power and Limitations of Private Governance Schemes. Available at SSRN 2577535.
- Baumann-Pauly, D., Nolan, J., Van Heerden, A., & Samway, M. (2017). Industry-specific multi-stakeholder initiatives that govern corporate human rights standards: Legitimacy assessments of the Fair Labor Association and the Global Network Initiative. *Journal of Business Ethics*, 143(4), 771-787.

- Becker, L. A. (2000). Effect Size (ES). *Web.Uccs.Edu*, 1(1), 1–14.
- Becker, S., Bryman, A., & Ferguson, H. (Eds.). (2012). *Understanding research for social policy and social work: themes, methods and approaches*. Policy Press.
- Beckert, J. (1999). Agency, entrepreneurs, and institutional change. The role of strategic choice and institutionalized practices in organizations. *Organization studies*, 20(5), 777-799.
- Bélanger, J., & Edwards, P. (2007). The conditions promoting compromise in the workplace. *British journal of industrial relations*, 45(4), 713-734.
- Bellemare, G. (2000). End users: actors in the industrial relations system?. *British Journal of Industrial Relations*, 38(3), 383-405.
- Bellini, A., Burroni, L., & Dorigatti, L. (2018). Industrial Relations and Creative Workers–Country Report: Italy. *Work*.
- Bennett, D. A. (2001). How can I deal with missing data in my study?. *Australian and New Zealand journal of public health*, 25(5), 464-469.
- Bergström, L. (1970). What is a Conflict of Interest?. *Journal of Peace Research*, 7(3), 197-217.
- Berik, G., & Rodgers, Y. (2009). Bangladesh's Ready-made Garments Sector: Exports, Employment and Working Conditions. *Journal of Bangladesh Studies*, 11(2), 1-19.
- Berik, G., & Rodgers, Y. V. D. M. (2010). Options for enforcing labour standards: Lessons from Bangladesh and Cambodia. *Journal of International Development: The Journal of the Development Studies Association*, 22(1), 56-85.
- Bernard, A. B., A. Moxnes, & K. H. Ulltveit-Moe (2018b): “Two-Sided Heterogeneity and Trade,” *Review of Economics and Statistics*, 100, 424–439.
- Bhuiyan, M. I. (2013). Reasonable Wages for Workers to Eliminate Unrest in Bangladesh’s Readymade Garments (RMG) Sector. *Fowler Street, USA: Bangladesh Development Research Center (BDRC)*.
- Biagi, M. (1990). From conflict to participation in safety: Industrial relations and the working environment in Europe 1992. *Int'l J. Comp. Lab. L. & Indus. Rel.*, 6, 67.
- Bishop Jr, A. N. (1957). Employers, Employees, and Inventions. *S. Cal. L. Rev.*, 31, 38.
- Black, S. E., & Lynch, L. M. (1998). The New Workplace: What Does It Mean for Productivity?. In *PROCEEDINGS OF THE ANNUAL MEETING-INDUSTRIAL RELATIONS RESEARCH ASSOCIATION*, 1, 60-67, Industrial Relations Research Association.

- Blanpain, R. (2010). Comparative labour law and industrial relations in industrialized market economies.
- Blumer, H. (1947). Sociological theory in industrial relations. *American Sociological Review*, 12(3), 271-278.
- Blyton, P. & Turnbull P (eds) (1994). Reassessing Human Resource Management. London: Sage.
- Blyton, P., & Turnbull, P. (1992). HRM: debates, dilemmas and contradictions. *Reassessing Human Resource Management, Sage, London*, 1-15.
- Blyton, P., & Turnbull, P. (2004). *The dynamics of employee relations*. Macmillan International Higher Education.
- Bollen, K. A., & Ting, K. F. (2000). A tetrad test for causal indicators. *Psychological methods*, 5(1), 3.
- Bollen, K., & Lennox, R. (1991). Conventional wisdom on measurement: A structural equation perspective. *Psychological bulletin*, 110(2), 305.
- Booth, A. L. (2014). The Economics of Trade Unions, (January 1997).
- Borsboom, D., Mellenbergh, G. J., & Van Heerden, J. (2003). The theoretical status of latent variables. *Psychological review*, 110(2), 203.
- Borsboom, D., Mellenbergh, G. J., & Van Heerden, J. (2004). The concept of validity. *Psychological review*, 111(4), 1061.
- Borsboom, Mellenbergh & Heerden, B. R. (2014). Common method variance techniques. *Cleveland State University, Department of Operations & Supply Chain Management. Cleveland, OH: SAS Institute Inc*, 1-11.
- Bottomore, T., Harris, L., Kiernan, V. G., & Miliband, R. (1991). *The marxist thought*. Oxford, England: Blackwell Publishers Ltd.
- Bratton, J., & Gold, J. (2017). *Human resource management: theory and practice*. Palgrave.
- Brigden, C. (2018). Work, Identity and Trade Union Responses and Strategies. In *Work and Identity* (pp. 133-146). Palgrave Macmillan, Cham.
- Brown, C., & Medoff, J. (1978). Trade unions in the production process. *Journal of political economy*, 86(3), 355-378.
- Brown, J. D. (2004). Research Methods for Applied Linguistics: Scope, Characteristics, and Standards. *The handbook of applied linguistics*, 476.

- Brown, R. (2013). *Understanding industrial organizations: Theoretical perspectives in industrial sociology*. Routledge.
- Bruce, K., & Nyland, C. (2011). Elton Mayo and the deification of human relations. *Organization studies*, 32(3), 383-405.
- Brunges, M., & Foley-Brinza, C. (2014). Projects for increasing job satisfaction and creating a healthy work environment. *AORN journal*, 100(6), 670-681.
- Bryman, A. (Ed.). (2006). *Mixed methods*. SAGE Publications Limited.
- Bryson, A., Barth, E., & Dale-Olsen, H. (2013). The effects of organizational change on worker well-being and the moderating role of trade unions. *ILR Review*, 66(4), 989-1011.
- Budd, J. W., & Colvin, A. J. (2008). Improved metrics for workplace dispute resolution procedures: Efficiency, equity, and voice. *Industrial Relations: A Journal of Economy and Society*, 47(3), 460-479.
- Budeli, M. (2010). Understanding the right to freedom of association at the workplace: components and scope. *Obiter*, 31(1), 16-33.
- Buncombe, A. (2009). End of Sri Lanka's civil war brings back tourists, The Independent World, Asia.
- Burrell, G., & Morgan, G. (1979). Paradigms in organizational studies. *New directions in*.
- Byrne, B. M. (2008). Testing for multigroup equivalence of a measuring instrument: A walk through the process. *Psicothema*, 20(4), 872-882.
- Byrne, D. (2002). *Complexity theory and the social sciences: An introduction*. Routledge.
- Cajal-Grossi, J., Macchiavello, R., & Noguera, G. (2019). International Buyers' Sourcing and Suppliers' Markups in Bangladeshi Garments.
- Calitz. (2009). *Introduction the pilot study*.
- Camerino, O., Castañer, M., & Anguera, T. M. (Eds.). (2014). *Mixed Methods Research in the Movement Sciences: Case studies in sport, physical education and dance* (Vol. 5). Routledge.
- Campaign, C. C. (2012). Hazardous workplaces: Making the Bangladesh Garment industry safe.
- Campbell, D. J. (2000). Legitimacy theory or managerial reality construction? Corporate social disclosure in Marks and Spencer Plc corporate reports, 1969–1997. In *Accounting forum* (Vol. 24, No. 1, pp. 80-100). Blackwell Publishers Ltd.

- Campbell, D. T. (1960). Recommendations for APA test standards regarding construct, trait, or discriminant validity. *American Psychologist*, 15(8), 546.
- Campbell, D. T., & Fiske, D. W. (1959). Convergent and discriminant validation by the multitrait-multimethod matrix. *Psychological bulletin*, 56(2), 81.
- Cannon, J. P., & Perreault Jr, W. D. (1999). Buyer–seller relationships in business markets. *Journal of marketing research*, 36(4), 439-460.
- Cappelli, P., Bassi, L., Katz, H., Knoke, D., Osterman, P., & Useem, M. (1997). *Change at work*. Oxford University Press on Demand.
- Carballo-Penela, A., Mateo Mantecón, I., Alvarez, S., & Castromán Diz, J. L. (2018). The role of green collaborative strategies in improving environmental sustainability in supply chains: Insights from a case study. *Business Strategy and the Environment*, 27(6), 728-741.
- Center for Policy Dialog (2016). *New Dynamics in Bangladesh's Apparels Enterprises Perspectives on Restructuring, Up-gradation and Compliance Assurance*, <http://rmg-study.cpd.org.bd/wp-content/uploads/2016/12/CPD-RMG-Study-Flyer.pdf>
- Chan, C. K. C. (2013). Promoting freedom of association in China? Putting transnational corporate social responsibility into a national context. *Journal of Comparative Asian Development*, 12(1), 6-34.
- Chandler, Alfred D., Jr. (1962). *Strategy and Structure*. New York: Anchor Books.
- Chapman, S. D. (1987). The cotton industry in the industrial revolution. In *The Industrial Revolution A Compendium* (pp. 1-64). Palgrave, London.
- Charamis, D. (2018). Increasing Competitiveness in the Textile Industry: A Focus on the Accounting Benefits of ERP Systems by Exploring Cases from the UK & Greece. *Theoretical Economics Letters*, 8(5), 1044-1057.
- Chavis, D. M., & Wandersman, A. (1990). Sense of community in the urban environment: A catalyst for participation and community development. *American Journal of Community Psychology*, 18(1), 55–81.
- Chelghoum, A., Takeda, S., Wilczek, B., & Homberg, F. (2016). The challenges and future of trade unionism in Algeria: a lost cause? *Employee Relations*, 38(3), 351–372.
- Chen, F. (2003). Between the state and labour: The conflict of Chinese TUs' double identity in market reform. *The China Quarterly*, 176, 1006-1028.
- Cherryholmes, C. H. (1992). Notes on pragmatism and scientific realism. *Educational researcher*, 21(6), 13-17.

- Chidi, C. O., & Okpala, O. P. (2012). Theoretical approaches to employment and industrial relations: a comparison of subsisting orthodoxies. *Theoretical and Methodological Approaches to Social Sciences and Knowledge Management*, 2(1), 264-277.
- Child, J. (1964). Quaker employers and industrial relations. *The Sociological Review*, 12(3), 293-315.
- Child, J. (1972). Organizational structure, environment and performance: The role of strategic choice. *sociology*, 6(1), 1-22.
- Child, J., Loveridge, R., & Warner, M. (2018). TOWARDS AN ORGANIZATIONAL STUDY OF TRADE UNIONS Author (s): John Child , Ray Loveridge and Malcolm Warner Published by: Sage Publications , Ltd . Stable URL : <https://www.jstor.org/stable/42851302>, 7(1), 71–91
- Chin, W. W. (1998). The partial least squares approach to structural equation modeling. *Modern methods for business research*, 295(2), 295-336.
- Choudhury, S., & Rahman, M. M. H. (2017). Labor Unrest in the Ready-Made Garment Industry of Bangladesh: Causes and Consequences. *European Scientific Journal, ESJ*, 13, 34-87.
- Chowdhury, D. S. (2017). Women's rights and voice in the ready-made garments sector of Bangladesh: evidence from theory and practice. *Journal of International Women's Studies*, 18(2), 118-133.
- Chowdhury, M., Ahmed, R., & Yasmin, M. (2014). Prospects and Problems of RMG Industry: A study on Bangladesh. *Prospects*, 5(7), 103-118.
- Chowdhury, N. J., & Ullah, M. H. (2010). Socio-Economic Conditions of Female Garment Workers in Chittagong Metropolitan Area–An Empirical Study. *Journal of Business and Technology (Dhaka)*, 5(2), 53-70.
- Chowdhury, T. M., & Rahel, M. (2020). The legal aspect of industrial relations practice in Bangladesh. *UUM Journal of Legal Studies*, 9, 205-220.
- Churchill Jr, G. A. (1979). A paradigm for developing better measures of marketing constructs. *Journal of marketing research*, 16(1), 64-73.
- Clark, C. E. (1968). Definition of Discrimination: Employers' Hiring. *Mercer L. Rev.*, 19, 334.
- Clark, P. F. (1989). 'Determinants of the quality of union-management relations: an exploratory study of union member perceptions'. *Journal of Collective Negotiations*, 18 (2): 103–15.
- Clark, P. F. (2010). *Building more effective unions*. Cornell University Press.

- Clarke, C. (2009). Paths between positivism and interpretivism: An appraisal of Hay's via media. *Politics*, 29(1), 28-36.
- Clews, H., Hatch, R., & Elkins, S. B. (1886). The Labor Crisis. *The North American Review*, 142(355), 598-616.
- Cocks, K., & Torgerson, D. J. (2013). Sample size calculations for pilot randomized trials: a confidence interval approach. *Journal of clinical epidemiology*, 66(2), 197-201.
- Cohen, D. J., & Crabtree, B. F. (2008). Evaluative criteria for qualitative research in health care: controversies and recommendations. *The Annals of Family Medicine*, 6(4), 331-339.
- Cohen, J. (1988). *Statistical power analysis for the behavioral sciences*, 2nd edn. Á/L.
- Colling, T., & Terry, M. (Eds.). (2010). *Industrial relations: Theory and practice*. John Wiley & Sons.
- Coltman, T. (2008). Formative versus reflective measurement models : Two applications of formative measurement. *Journal of Business Research*, 61(12), 1250–1262.
- Coltman, T., Devinney, T. M., Midgley, D. F., & Venaik, S. (2008). Formative versus reflective measurement models: Two applications of formative measurement. *Journal of Business Research*, 61(12), 1250-1262.
- Comboh, M. A. (2014). Examine Conflicts in Industrial Relations & Collective Bargaining Context and its Impact on Workers & Organization Performance. *Academy of Contemporary Research Journal*, 3(1), 14-25.
- Cooperative, S. C. R. (2017). What is Supply Chain Management (SCM). *NC STATE UNIVERSITY*. Available online: <https://scm.ncsu.edu/scmarticles/article/what-is-supply-chain-management-scm>.
- Cradden, C. (2011). Unitarism, pluralism, radicalism... and the rest?. Genève :Université de Genève.
- Creswell, J. W., & Creswell, J. D. (2017). *Research design: Qualitative, quantitative, and mixed methods approaches*. Sage publications.
- Creswell, J. W., & Vicki, L. Plano-Clark.(2007). *Designing and conducting mixed methods research*.
- Crinis, V. D., & Vickers, A. H. (2017). Introduction: dis-organisinglabour in the clothing industry in the Asia Pacific.
- Cronbach, L. J. (1951). Coefficient alpha and the internal structure of tests. *psychometrika*, 16(3), 297-334.

- Crotty, M. (1998). *The foundations of social research: Meaning and perspective in the research process*. Sage.
- Cullinane, N., & Dundon, T. (2014). Unitarism and employer resistance to trade unionism. *The International Journal of Human Resource Management*, 25(18), 2573-2590.
- Cummins, R. A., & Gullone, E. (2000, March). Why we should not use 5-point Likert scales: The case for subjective quality of life measurement. In *Proceedings, second international conference on quality of life in cities* (Vol. 74, p. 93).
- Dabscheck, B. (1983). Of mountains and routes over them: a survey of theories of industrial relations. *Journal of Industrial Relations*, 25(4), 485-506.
- Das, K. R., & Imon, A. H. M. R. (2016). A brief review of tests for normality. *American Journal of Theoretical and Applied Statistics*, 5(1), 5-12.
- Das, S. (2008). Social compliance Issue in the apparel sector of Bangladesh. *Official web site of Fiber*, 2.
- Dasgupta, S. (2002). Attitudes towards trade unions in Bangladesh, Brazil, Hungary and Tanzania. *Int'l Lab. Rev.*, 141, 413.
- Davidov, G. (2004). Joint employer status in triangular employment relationships. *British Journal of Industrial Relations*, 42(4), 727-746.
- Davies, P. L., & Freedland, M. (2007). *Towards a flexible labour market: Labour legislation and regulation since the 1990s*. Oxford University Press.
- Deakin, S. F., & Morris, G. S. (2012). *Labour law*. Hart publishing.
- Deegan, C. (2002). The legitimising effect of social and environmental disclosures—a theoretical foundation. *Accounting, Auditing & Accountability Journal*, 15(3), 282-311.
- Deery, S. J., Iverson, R. D., & Erwin, P. J. (1994). Predicting organizational and union commitment: The effect of industrial relations climate. *British Journal of Industrial Relations*, 32(4), 581-597.
- Deery, S., Iverson, R., & Erwin, P. (1999). Industrial relations climate, attendance behaviour and the role of trade unions. *British Journal of Industrial Relations*, 37(4), 533-558.
- Denis, J. L., Langley, A., & Rouleau, L. (2007). Strategizing in pluralistic contexts: Rethinking theoretical frames. *Human relations*, 60(1), 179-215.
- Department of Labor, 2020 retrieved from <http://103.48.18.197/bn/trade>
- Department of Labour (2020). *Publicly Accessible Database*, <http://103.48.18.197/demo>.

- Derksen, M. (2014). Turning men into machines? Scientific management, industrial psychology, and the “human factor”. *Journal of the History of the Behavioral Sciences*, 50(2), 148-165.
- Derthick, M. (2011). *Agency under stress: The social security administration in American government*. Brookings Institution Press.
- Dhal, M. (2011). Changing Power of Union in India: A Study of Actors' Perception. *International Journal of Human Resource Studies*, 1(2), 111.
- Diamantopoulos, A. (2006). The error term in formative measurement models: interpretation and modeling implications. *Journal of modelling in management*.
- Diamantopoulos, A., & Sigauw, J. A. (2006). Formative versus reflective indicators in organizational measure development: A comparison and empirical illustration. *British journal of management*, 17(4), 263-282.
- Diamantopoulos, A., & Winklhofer, H. M. (2001). Index construction with formative indicators: An alternative to scale development. *Journal of marketing research*, 38(2), 269-277.
- Dickens, L. (2000). Promoting gender equality at work—a potential role for trade union action. *Journal of Interdisciplinary Gender Studies: JIGS*, 5(2), 27.
- Dickens, L., & Hall, M. (2003). Labour law and industrial relations: a new settlement?. *Industrial relations: Theory and practice*, 24-56.
- Dikko, M. (2016). Establishing Construct Validity and Reliability: Pilot Testing of a Qualitative Interview for Research in Takaful (Islamic Insurance). *Qualitative Report*, 21(3).
- Dimitrov, D. M. (2014). *Statistical methods for validation of assessment scale data in counseling and related fields*. John Wiley & Sons.
- Ding, D. Z., Goodall, K., & Warner, M. (2002). The impact of economic reform on the role of trade unions in Chinese enterprises. *International journal of human resource management*, 13(3), 431-449.
- Do, C. Q. (2011). Understanding Industrial Relations Transformation in Vietnam: A multi-dimensional approach.
- Dobson, J. R. (1982). What is good industrial relations?. *Employee Relations*.
- Donaghey, J., & Reinecke, J. (2018). When industrial democracy meets corporate social responsibility—A comparison of the Bangladesh accord and alliance as responses to the Rana Plaza disaster. *British Journal of Industrial Relations*, 56(1), 14-42.

- Dowling, J., & Pfeffer, J. (1975). Organizational Legitimacy: Social Values and Organizational Behavior. *University of California Press*, 18(1), 122–136.
- Dowrick, S., & Gemmell, N. (1991). Industrialisation, catching up and economic growth: a comparative study across the world's capitalist economies. *The Economic Journal*, 101(405), 263-275.
- Duah, P., & Danso, P. A. (2017). Employee relations and its effect on organisational performance. *International Journal of Multidisciplinary Research and Development*, 4(10), 27-32.
- Duara, M., & Mallick, S. (2019). Women Workers & Industrial Relations in Tea Estates of Assam. *Indian Journal of Industrial Relations*, 55(1).
- Dubin, R. (2017). *The world of work: Industrial society and human relations*. Taylor & Francis.
- Dundon, T., & Eva, D. (1998). Trade unions and bargaining for skills. *Employee Relations*.
- Dundon, T., & Rollinson, D. (2004). *Employment relations in non-union firms* (Vol. 12). Routledge.
- Dundon, T., Wilkinson, A., Marchington, M., & Ackers, P. (2004). The meanings and purpose of employee voice. *The International Journal of Human Resource Management*, 15(6), 1149-1170.
- Dunlop, J. T. (1993). *Industrial relations systems*. Harvard Business Sch.
- Dunlop, J.T. (1958). *Industrial Relations Systems*, Holt, New York, 1958, p. 380.
- Dunning, H. (1998). The origins of Convention No. 87 on freedom of association and the right to organize. *Int'l Lab. Rev.*, 137, 149.
- Eaton, A. E., & Voos, P. B. V. (1989). *Unions and contemporary innovations in work organization, compensation, and employee participation*. Industrial Relations Centre, Queen's University.
- Eaton, J., Jinkins, D., Tybout, J., & Xu, D. (2016, October). Two-sided search in international markets. In *2016 Annual Meeting of the Society for Economic Dynamics*.
- Ebisui, M. (2012). Non-standard workers: Good practices of social dialogue and collective bargaining. *E-Journal of International and Comparative Labour Studies*, 1(3-4).
- Edison Anthony Raj, A., & Rajakrishnan, V. S. (2014). A Study on Industrial Disputes and its effects: Exceptional reference to Indian Industries. *EDUVED International Journal of Interdisciplinary Research*, 1(6), 1-8.

- Edwards, J. R., & Bagozzi, R. P. (2000). On the nature and direction of relationships between constructs and measures. *Psychological methods*, 5(2), 155.
- Edwards, P. (1995). The employment relationship. *Industrial relations: theory and practice in Britain*. Oxford: Blackwell, 256.
- Edwards, P. (Ed.). (2009). *Industrial relations: theory and practice*. John Wiley & Sons.
- Edwards, P., Bélanger, J., & Wright, M. (2006). The bases of compromise in the workplace: A theoretical framework. *British journal of industrial relations*, 44(1), 125-145.
- Eichhorn, B. R. (2014). Common method variance techniques. *Cleveland State University, Department of Operations & Supply Chain Management*. Cleveland, OH: SAS Institute Inc.
- Elahi, S., Hosen, M. D., & Nizam, M. E. H. (2019). Comparative analysis in RMG industries before and after Rana Plaza incident in Bangladesh. *J Textile Eng Fashion Technol*, 5(4), 202-211.
- El-Garaihy, W. H., Mobarak, A.-K. M., & Albahussain, S. A. (2014). Measuring the Impact of Corporate Social Responsibility Practices on Competitive Advantage: A Mediation Role of Reputation and Customer Satisfaction. *International Journal of Business and Management*, 9(5), 109–124.
- El-Haj, T. A. (2014). Friends, Associates, and Associations: Theoretically and Empirically Grounding the Freedom of Association. *Ariz. L. Rev.*, 56, 53.
- Ellegaard, C., Johansen, J., & Drejer, A. (2003). Managing industrial buyer- supplier relations—the case for attractiveness. *Integrated Manufacturing Systems*.
- Emerson, R. W. (2015). Convenience sampling, random sampling, and snowball sampling: How does sampling affect the validity of research?. *Journal of Visual Impairment & Blindness*, 109(2), 164-168.
- Emmenegger, P., Graf, L., & Strebel, A. (2020). Social versus liberal collective skill formation systems? A comparative-historical analysis of the role of trade unions in German and Swiss VET. *European Journal of Industrial Relations*, 26(3), 263-278.
- Esposito Vinzi, V., Chin, W. W., Henseler, J., & Wang, H. (2010). *Handbook of partial least squares: Concepts, methods and applications*. Heidelberg, Dordrecht, London, New York: Springer.
- Estes, R. J., & Tiliouine, H. (2014). Development trends in Islamic societies: From collective wishes to concerted actions. *Social Indicators Research*, 116(1), 67-114.

- Ethical Trading Initiative. (2010). Working with trade unions to improve working conditions: the benefits for retailers and suppliers. *London: Ethical Training Initiative.*
- Etikan, I., Musa, S. A., & Alkassim, R. S. (2016). Comparison of convenience sampling and purposive sampling. *American journal of theoretical and applied statistics*, 5(1), 1-4.
- Ewing, K. D. (1984). *Trade Unions, the Labour Party and the Law*. Edinburgh University Press.
- Export Promotion Bureau (2019). *Readymade Garments Industry of Bangladesh*, http://epb.gov.bd/site/view/epb_export_data/2019-2020/July-June/6659.
- Ezaz, W. M. I. (2018). Impact of Repression of Trade Unions on Working Conditions: A Bangladesh Perspective.
- Faini, R. (1999). Trade unions and regional development. *European Economic Review*, 43(2), 457-474.
- Faiz, M., & Maitra, P. (2020). Concentration and Diversification of Export Economy of Bangladesh: Comparison and Policy Implication with Other Asian Countries. *South Asian Journal of Social Studies and Economics*, 19-36.
- Fajana, S. (2005) *Industrial Relations in Nigeria: Theory and Features* (3rd ed). Lagos: Nigeria: Labofin and Company.
- Fallon Jr, R. H. (1992). Individual rights and the powers of government. *Ga. L. Rev.*, 27, 343.
- Farhana, K., Syduzzaman, M., & Munir, M. S. (2015). Present status of workers in ready-made garments industries in Bangladesh. *European Scientific Journal*, 11(7).
- Faridah, I., Hashim, A. E., Salimin, R. M., & Mahmood, M. A. (2010). Behaviour Based Safety Approach: A Mechanism for Workplace Safety Improvement. In *Proceedings of International Conference of Construction Project Management (ICCPM)*.
- Farnham, D., & Pimlott, J. (1995). *Understanding industrial relations*. Burns & Oates
- Farrell, A. M. (2010). Insufficient discriminant validity: A comment on Bove, Pervan, Beatty, and Shiu (2009). *Journal of business research*, 63(3), 324-327.
- Fashoyin, T. (2005). Tripartism and other actors in social dialogue. *Int'l J. Comp. Lab. L. & Indus. Rel.*, 21, 37.
- Feldman, S. (2009). Historicizing garment manufacturing in Bangladesh: gender, generation, and new regulatory regimes. *Journal of International Women's Studies*, 11(1), 268-288.
- Fells, R. E. (1989). The employment relationship, control and strategic choice in the study of industrial relations. *Labour & Industry: a journal of the social and economic relations of work*, 2(3), 470-492.

- Ferdous, A. (2011). Working conditions in the Bangladesh readymade garments industry: is social compliance making a difference?.
- Fernando, Y., Zailani, S., & Janbi, L. (2008). The determinant factors of safety compliance at petrochemical processing area. Moderator effects of employees experience and engineering background. In *Proceedings of the 9th Asia Pasific Industrial Engineering & Management Systems Conference* (pp. 1442-1452).
- Fick, B. J. (2009). Not just collective bargaining: The role of trade unions in creating and maintaining a democratic society. *WorkingUSA*, 12(2), 249-264.
- Fidler, J. E. (1981). *The British business elite: Its attitudes to class, status, and power*. Routledge.
- Findlay, P., Commander, J., & Warhurst, C. (2011). The role of trade unions in effective skills utilisation: three Scottish case studies. In *a report for Scottish Union Learning and the Scottish Trades Union Congress, Scottish Centre for Employment Research, University of Strathclyde, Glasgow*.
- Flanders, A. (1975), *Management and Unions: The Theory and Reforms of Industrial Relations*, Faber and Faber, London.
- Fleming, J., & Peetz, D. (2005). Essential service unionism and the new police industrial relations.
- Fong, C. C. (2005). *A Pseudo Longitudinal Study of Using Intranet for Supporting Management Accounting: Evidence from Hong Kong Public Hospitals*. Curtin University of Technology.
- Ford, D. (1984). *Buyer/seller relationships in international industrial markets*. *Industrial Marketing Management*, 13(2), 101–112.
- Fornell, C., & Larcker, D. F. (1981). Evaluating Structural Equation Models with Unobservable Variables and Measurement Error. *Journal of Marketing Research*, 18(1), 39–50.
- Foster, B., & Rasmussen, E. (2010). *Employers' Attitudes to Collective Bargaining* (pp. 116-132). Auckland: Auckland University Press.
- Fox, A. (1966). Industrial sociology and industrial relations: An assessment of the contribution which industrial sociology can make towards understanding and resolving some of the problems now being considered by the Royal Commission (No. 3). HM Stationery Office.
- Fox, A. (1973). Industrial relations: a social critique of pluralist ideology. *Man and organization*, 185-233.

- Frank, D. (2005). *Bananeras: Women transforming the banana unions of Latin America*. South End Press.
- Freeman, R. (1992). Is declining unionization of the US good, bad or irrelevant. *Unions and economic competitiveness*.
- Freeman, R. B., & Kleiner, M. M. (1990). Employer behavior in the face of union organizing drives. *ILR Review*, 43(4), 351-365.
- Freeman, R. B., Boxall, P. F., & Haynes, P. (Eds.). (2007). *What workers say: Employee voice in the Anglo-American workplace*. Cornell University Press.
- Freeman, R. E., & Phillips, R. A. (2002). Stakeholder theory: A libertarian defense. *Business ethics quarterly*, 12(3), 331-349.
- Freeman, R. E., Harrison, J. S., Wicks, A. C., Parmar, B. L., & De Colle, S. (2010). *Stakeholder theory: The state of the art*. Cambridge University Press.
- Fudge, J. (2015). Constitutionalizing labour rights in Canada and Europe: Freedom of association, collective bargaining, and strikes. *Current Legal Problems*, 68(1), 267-305.
- Fugard, A. J., & Potts, H. W. (2015). Supporting thinking on sample sizes for thematic analyses: a quantitative tool. *International Journal of Social Research Methodology*, 18(6), 669-684.
- Gaffar Khan, A., UIHuq, S. M., & Islam, N. (2019). Job Satisfaction of Garments Industry in a Developing Country. *Management Studies and Economic Systems*, 4(2), 115-122.
- Galenson, W. (ed). 1992. *Labor and Economic Growth in Five Asian Countries: South Korea, Malaysia, Taiwan, Thailand and the Philippines*. New York: Greenwood Publishing Group.
- Gall, M. D., Gall, J. P., & Borg, W. R. (2003). *Educational research: An introduction* (7th ed.). Boston, MA: Pearson.
- Gallagher, D. G., & Clark, P. F. (1989). Research on union commitment: Implications for labor. *Lab. Stud. J.*, 14, 52.
- Geare, A., Edgar, F., & McAndrew, I. (2006). Employment relationships: Ideology and HRM practice. *The International Journal of Human Resource Management*, 17(7), 1190-1208.
- Gefen, D., Straub, D., & Boudreau, M. C. (2000). Structural equation modeling and regression: Guidelines for research practice. *Communications of the association for information systems*, 4(1), 7.

- Geisser, S. (2012). The Predictive Sample Reuse Method with Applications. *Journal of the American Statistical Association*, (February), 320–328.
- Gereffi, G. (1999). International trade and industrial upgrading in the apparel commodity chain. *Journal of international economics*, 48(1), 37-70.
- Ghasemi, A., & Zahediasl, S. (2012). Normality tests for statistical analysis: a guide for non-statisticians. *International journal of endocrinology and metabolism*, 10(2), 486.
- Ghayur, S. (2009). Evolution of the industrial relations system in Pakistan, *International Labor Organization*, Cornell University ILR School.
- Ghosh, A., & Ray, P. (2012). A contemporary model for industrial relations: Relook from global perspective. *Management and Labour Studies*, 37(1), 17-30.
- Gibb, S., & Ishaq, M. (2020). Decent work: what matters most and who can make a difference?. *Employee Relations: The International Journal*.
- Godard, J. (2002). Institutional environments, employer practices, and states in liberal market economies. *Industrial Relations: A Journal of Economy and Society*, 41(2), 249-286.
- Goedeke, S., Daniels, K., Thorpe, M., & Du Preez, E. (2015). Building extended families through embryo donation: the experiences of donors and recipients. *Human Reproduction*, 30(10), 2340-2350.
- Gold, A. H., Malhotra, A., & Segars, A. H. (2001). Knowledge management: An organizational capabilities perspective. *Journal of management information systems*, 18(1), 185-214.
- Goldberg, S. B., Sander, F. E., Rogers, N. H., & Cole, S. R. (2014). *Dispute resolution: Negotiation, mediation and other processes*. Wolters Kluwer Law & Business.
- Goberman, L., Hauptmeier, M., & Heery, E. (2019). The decline of Employers' Associations in
- Gospel, H. (1983). Managerial structure and strategies: an introduction. *Managerial Strategies and Industrial Relations: An Historical and Comparative Study (London, 1983)*, 1, 24.
- Gough, R. (2020). Employee Voice at Work. *Journal of Industrial Relations*, 62(2), 320–322.
- Gourevitch, P., Martin, A., Ross, G., Bornstein, S., Markovits, A., & Allen, C. (2016). *Unions and Economic Crisis: Britain, West Germany and Sweden*. Routledge.
- Greene, A. M. (2015). Voice and workforce diversity. *Finding a voice at work*, 67-94.

- Greene, J. C., Caracelli, V. J., & Graham, W. F. (1989). Toward a conceptual framework for mixed-method evaluation designs. *Educational evaluation and policy analysis, 11*(3), 255-274.
- Grix, J. (2004). *The Foundations of Research*. New York, NY: Palgrave Macmillan.
- Guba, E. G., & Lincoln, Y. S. (1994). Competing paradigms in qualitative research. *Handbook of qualitative research, 2*(163-194), 105.
- Guerci, M., & Shani, A. B. R. (2014). Stakeholder involvement in human resource management practices: Evidence from Italy. *management revue, 80*-102.
- Guest, D. (1989). Personnel and HRM. *Personnel management, 21*(1), 48-51.
- Guest, G., Bunce, A., & Johnson, L. (2006). How many interviews are enough? An experiment with data saturation and variability. *Field methods, 18*(1), 59-82.
- Gumbrell-McCormick, R., & Hyman, R. (2013). *Trade unions in Western Europe: hard times, hard choices*. Oxford University Press.
- Gupta, A. (2014). Trade Unions & Industrial Relations. *Global Journal of Research in Management, 4*(1), 86.
- Gupta, S., Bostrom, R. P., & Huber, M. (2010). End-user training methods: what we know, need to know. *ACM SIGMIS Database: the DATABASE for Advances in Information Systems, 41*(4), 9-39.
- Habib, M. R. I. (2016). Backward Linkages in the Ready Made Garment Industry of Bangladesh: Appraisal and Policy Implications. *The South East Asian Journal of Management, 129*-146.
- Habibur, R. M., & Siddiqu, S. M. (2015). Female RMG worker: Economic Contribution in Bangladesh. *International Journal of Scientific and Research Publications, 5*(9).
- Haider, M. Z. (2007). Competitiveness of the Bangladesh ready-made garment industry in major international markets. *Asia-Pacific Trade and Investment Review, 3*(1), 3-27.
- Hair Jr, J. F., Hult, G. T. M., Ringle, C., & Sarstedt, M. (2017a). *A primer on partial least squares structural equation modeling (PLS-SEM)*. Sage publications.
- Hair Jr, J. F., Sarstedt, M., Ringle, C. M., & Gudergan, S. P. (2017). *Advanced issues in partial least squares structural equation modeling*. saGe publications.
- Hair, J. F. (2015). *Essentials of business research methods*. ME Sharpe.
- Hair, J. F., Black, W. C., Babin, B. J., & Anderson, R. E. (2010). *Multivariate data analysis* (7th ed.). Englewood Cliffs: Prentice Hall.

- Hair, J. F., Ringle, C. M., & Sarstedt, M. (2011). PLS-SEM: Indeed a Silver Bullet. *The Journal of Marketing Theory and Practice*, 19(2), 139–152.
- Hair, J. F., Sarstedt, M., Hopkins, L., & Kuppelwieser, V. G. (2014). *Partial least squares structural equation modeling (PLS-SEM): An emerging tool in business research*. *European Business Review* (Vol. 26).
- Hak-Soo, O. (2010). Occurrence Mechanism and Resolution Process of Labor Disputes: Cases of Community Unions (Kyushu Area). *Labor Review*, 7(1), 83.
- Hamja, A., Maalouf, M., & Hasle, P. (2019). The effect of lean on occupational health and safety and productivity in the garment industry—a literature review. *Production & Manufacturing Research*, 7(1), 316-334.
- Han, S. L., Wilson, D. T., & Dant, S. P. (1993). Buyer-supplier relationships today. *Industrial marketing management*, 22(4), 331-338.
- Hanami, T. A. (2013). *Labour law and industrial relations in Japan*. Springer.
- Hankins, M., Fraser, A., Hodson, A., Hooley, C., & Smith, H. (2007). Measuring patient satisfaction for the Quality and Outcomes Framework. *The British Journal of General Practice : The Journal of the Royal College of General Practitioners*, 57(542), 737–740.
- Haq, A. Z. M. (2018). The Role of a Buying House in Readymade Garment Industries of Bangladesh. *International Journal of Service Science, Management and Engineering*, 5(3), 93.
- Haque, M. (2018). *Mathematical models to explain the export of Bangladesh* (Doctoral dissertation, BRAC University).
- Harcourt, J. M. (1993). Three Theoretical Approaches to Industrial Relations: A Reconciliation?. *Indian Journal of Industrial Relations*, 220-227.
- Hasan, K. F., Mia, M. S., Rahman, M. M., Ullah, A. A., & Ullah, M. S. (2016). Role of textile and clothing industries in the growth and development of trade & business strategies of Bangladesh in the global economy. *International Journal of Textile Science*, 5(3), 39-48.
- Hasan, K., Islam, A., & Arifuzzaman, M. (2015). A Study on the major causes of labour unrest and its effect on the RMG sector of Bangladesh. *International Journal of Scientific & Engineering Research*, 6(11), 199-212.
- Hasan, M. (2017). Supply Chain Management in Readymade Garments Industry, Bangladesh. *Asian Business Review*, 7(3), 14-110.
- Hasan, M. (2018). Minimum Wage in Readymade Garments Industry in Bangladesh. *American Journal of Trade and Policy*, 5(3), 111-120.

- Hasan, M. (2019). *Readymade Garment (RMG) in Bangladesh: A study on Social Compliance with Special Focus on Ashulia Industrial Area* (Doctoral dissertation, University of Dhaka).
- Hasan, M. M. (2018). Fragility analysis of typical RMG buildings of Bangladesh for progressive collapse.
- Hasan, M. M., Hossain, B. S., Alam, M. J., Chowdhury, K. A., Al Karim, A., & Chowdhury, N. M. K. (2018). The Prospects of Blue Economy to Promote Bangladesh into a Middle-Income Country. *Open Journal of Marine Science*, 8(03), 355.
- Hasan, M. M., Parven, T., Khan, S., Mahmud, A., & Yajuan, L. (2018). Trends and impacts of different barriers on Bangladeshi RMG industry's sustainable development. *International Research Journal of Business Studies*, 11(3), 245-260.
- Hasan, M. Z., Haque, S., & Khan, E. A. N. (2020). Buyer Paying Lower Price of Bangladeshi Apparel: An Empirical Investigation on Causes. *American Scientific Research Journal for Engineering, Technology, and Sciences (ASRJETS)*, 72(1), 152-161.
- Hassan, S. H., Ramayah, T., Mohamed, O., & Maghsoudi, A. (2015). E-lifestyle, customer satisfaction, and loyalty among the generation Y mobile users. *Asian Social Science*, 11(4), 157–168.
- Hauptmeier, M. (2015). Employer and Worker Collective Action: A Comparative Study of Germany, South Africa, and the United States-by Andrew Lawrence. *ILR Rev.: J. Work & Pol'y*, 68, 969.
- Havard, C., Rorive, B., & Sobczak, A. (2009). Client, employer and employee: Mapping a complex triangulation. *European Journal of Industrial Relations*, 15(3), 257-276.
- Hayter, S. (Ed.). (2011). *The role of collective bargaining in the global economy: Negotiating for social justice*. Edward Elgar Publishing.
- Hayter, S., & Lee, C. H. (Eds.). (2018). *Industrial relations in emerging economies: The quest for inclusive development*. Edward Elgar Publishing.
- Headey, B. W. (1970). Trade unions and national wages policies. *The Journal of Politics*, 32(2), 407-439.
- Heath, R., & Mobarak, A. M. (2015). Manufacturing growth and the lives of Bangladeshi women. *Journal of Development Economics*, 115, 1-15.
- Heery, E. (2015). Unions and the organising turn: Reflections after 20 years of organising works. *The Economic and Labour Relations Review*, 26(4), 545-560.

- Heery, E. (2016). British industrial relations pluralism in the era of neoliberalism. *Journal of Industrial Relations*, 58(1), 3-24.
- Heery, E., & Frege, C. (2006). New actors in industrial relations. *British Journal of Industrial Relations*, 44(4), 601-604.
- Heise, S. (2018): "Firm-to-Firm Relationships and Price Rigidity: Theory and Evidence," mimeo.
- Henseler, J., Ringle, C. M., & Sarstedt, M. (2015). A new criterion for assessing discriminant validity in variance-based structural equation modeling. *Journal of the academy of marketing science*, 43(1), 115-135.
- Henseler, J., Ringle, C. M., & Sinkovics, R. R. (2009). The use of partial least squares path modeling in international marketing. In *New challenges to international marketing*. Emerald Group Publishing Limited.
- Hertzog, M. A. (2008). Considerations in determining sample size for pilot studies. *Research in nursing & health*, 31(2), 180-191.
- Hicks, J., Sappey, R. B., Basu, P. K., & Burgess, J. (2009). Australian Christian churches and 'new' actors in industrial relations theory. *International Journal of Employment Studies*, 17(1), 164.
- Hill, R. (1998). What sample size is "enough" in internet survey research. *Interpersonal Computing and Technology: An electronic journal for the 21st century*, 6(3-4), 1-12.
- Himi, S. A., & Rahman, A. (2013). WORKERS' UNREST IN GARMENT INDUSTRIES IN BANGLADESH: AN EXPLORATORY STUDY. *Journal of Organisation & Human Behaviour*, 2(3).
- Hitt, M. A., & Tyler, B. B. (1991). Strategic decision models: Integrating different perspectives. *Strategic management journal*, 12(5), 327-351.
- Hom, P. W., Tsui, A. S., Wu, J. B., Lee, T. W., Zhang, A. Y., Fu, P. P., & Li, L. (2009). Explaining employment relationships with social exchange and job embeddedness. *Journal of Applied Psychology*, 94(2), 277.
- Hopkins, B., & Dawson, C. (2016). Migrant workers and involuntary non-permanent jobs: agencies as new IR actors?. *Industrial Relations Journal*, 47(2), 163-180.
- Höpner, M. (2005). What connects industrial relations and corporate governance? Explaining institutional complementarity. *Socio-Economic Review*, 3(2), 331-358.
- Hoque, Z., & Hopper, T. (1997). Political and industrial relations turbulence, competition and budgeting in the nationalised jute mills of Bangladesh. *Accounting and business Research*, 27(2), 125-143.

- Hosen, M. D., Elahi, S., Nizam, M. E. H., Ali, S. B., & Shifat, R. I. (2019). Comparative analysis in RMG industries before and after Rana Plaza incident in Bangladesh. *Journal of Textile Engineering & Fashion Technology*, 5(5).
- Hoshen, M. (2014). Brand and Quality Control of Garment Products in the Bangladesh Garment Industry, Karelia University of Applied Sciences, Finland.
- Hossain, J. (2012). *Economic Security for the Working Poor? Trade-Linked Labor Standards, Workers' Rights, and the Politics of Representation of Bangladesh's Garment Workers* (Doctoral dissertation, University of Trento).
- Hossain, J., & Akter, A. (2015). State of Bangladesh's RMG Sector Tripartism and the Scope of Harmonious Industrial and Labour Relations.
- Hossain, J., Ahmed, M., & Akter, A. (2010). Bangladesh Labour Law: Reform Directions. *People Tree Foundation*.
- Hossain, M. A., & Arefin, S. (2015). The Role of Buyers Compliance to Improve Workplace Environment of Garments Factories in Bangladesh. *International Journal of Humanities and Management Sciences (IJHMS)*, 3(4), 2320-4044.
- Hossain, M. & Ahmed, K. S. (2013). Illumination Conditions and Visual Comfort in Production Spaces of Ready-Made Garments Factories in Dhaka. *IACSIT International Journal of Engineering and Technology*, 5(5).
- Hossain, M. S. (2019). *Antecedents And Outcome Of Corporate Community Development Practices: A Study Among The Islamic Banks In Bangladesh* (Doctoral dissertation, Universiti Sains Malaysia).
- Hossain, M. U., & Roy, I. (2016). Supply chain management for sustainable RMG growth in Bangladesh. *International Journal of Science and Research*, 5(4), 1242-1248.
- Hossain, S., Kabir, R., & Latifee, E. H. (2019). Export Competitiveness of Bangladesh Readymade Garments Sector: Challenges and Prospects. *International Journal of Research in Business and Social Science*, 8(3), 45-63.
- Hossain, T., & Shirazi, H. (2018). Quality of Work Life among Women Employees Working in RMG Sector of Bangladesh. *Global Disclosure of Economics and Business*, 7(1), 27-40.
- Hossain, C. G., Sarker, M. A. R., & Afroze, R. (2012). Recent unrest in the RMG sector of Bangladesh: is this an outcome of poor labour practices?. *International Journal of Business and Management*, 7(3), 206-218.
- Howell, C. (2005). *Trade unions and the state: the construction of industrial relations institutions in Britain, 1890-2000*. Princeton University Press.

- Huang, K. P., Tung, J., Lo, S. C., & Chou, M. J. (2013). A review and critical analysis of the principles of scientific management. *International Journal of Organizational Innovation (Online)*, 5(4), 78.
- Huang, L., Wu, C., & Wang, B. (2019). Challenges, opportunities and paradigm of applying big data to production safety management: From a theoretical perspective. *Journal of cleaner production*, 231, 592-599.
- Hulland, J. (1999). Use of partial least squares (PLS) in strategic management research: A review of four recent studies. *Strategic management journal*, 20(2), 195-204.
- Huws, U. (2014). *Labor in the global digital economy: The cybertariat comes of age*. NYU Press.
- Hyman, R. (1975). What is Industrial Relations?. In *Industrial Relations* (pp. 9-31). Palgrave Macmillan, London.
- Hyman, R. (1996). Institutional transfer: industrial relations in Eastern Germany. *Work, Employment and Society*, 10(4), 601-639.
- Hyman, R. (2002). The future of unions. *Just Labour*.
- Hyman, R. (2007). How can trade unions act strategically?. *Transfer: European Review of Labour and Research*, 13(2), 193-210.
- Hyman, R. (2007): "An Anglo-European perspective on industrial relations research". *Arbetsmarknad&Arbetsliv*, vol 13, nos 3-4, pp 29-41.
- Hyman, R. (2008). The state in industrial relations. *The Sage handbook of industrial relations*, 258-83.
- Hyman, R. (2013). The role of government in industrial relations. In *Labour Administration in Uncertain Times*. Edward Elgar Publishing.
- Hyman, R. 1975. *Industrial Relations: A Marxist Introduction*. London: Macmillan.
- Hyman, R. 2015. 'Three scenarios for industrial relations in Europe', *International Labour Review*, 154(1), 5–14.
- Hyman, R., & Gumbrell-McCormick, R. (2010). Trade unions, politics and parties: is a new configuration possible?. *Transfer: European Review of Labour and Research*, 16(3), 315-331.
- Ibrahim, I. M. (2013). *Impact of trade union on improving employees working conditions: The case study of COTWU and TUGHE* (Doctoral dissertation, The Open University of Tanzania).
- International Labor Organization (2019). *Trade Unions in Bangladesh : Promoting Safe and Healthy Workplaces in the Ready Made Garment (RMG) Sector information: consultation with donors and Government response*.

- International Labor Organization (2017). *Promoting pathways to decent work*, <https://www.ilo.org/global/research/projects/active-labour-market-policies/pathways/lang--en/index.htm>.
- Ishaque, M., (2019). RMG Industry Outlook 2019. <http://textilefocus.com/rmg-industry-outlook-2019/>
- Islam, F., & Asaduzzaman, M. (2015). Legal framework for trade unionism in Bangladesh. *Annual Report of the Ministry of Labour and Employment, 2012(13)*, 21.
- Islam, H. (2018). Labor law and its implication in RMG Sector in Bangladesh.
- Islam, M. A., Barna, S. D., Raihan, H., Khan, M. N. A., & Hossain, M. T. (2020). Depression and anxiety among university students during the COVID-19 pandemic in Bangladesh: A web-based cross-sectional survey. *PloS one, 15(8)*.
- Islam, M. A., Jantan, A. H., Hashim, H., Chong, C. W., & Abdullah, M. M. (2018). Factors Influencing Female Progression in Leadership Positions in the Ready-Made Garment (RMG) Industry in Bangladesh. *Journal of International Business and Management (JIBM), 1(1)*, 1-13.
- Islam, M. M., & Adnan, A. T. M. (2016). Improving ready-made garment productivity by changing worker attitude. *European Scientific Journal, 12(4)*.
- Islam, M. R., & Morgan, W. J. (2011). Non-governmental organizations in Bangladesh: their contribution to social capital development and community empowerment. *Community Development Journal, 47(3)*, 369-385.
- Islam, M. R., & Haque, M. (2018). The trends of export and its consequences to the GDP of Bangladesh. *Journal of Social Sciences and Humanities, 1(1)*, 63-67.
- Islam, M. S., Rakib, M. A., & Adnan, A. (2016). Ready-made garments sector of Bangladesh: Its contribution and challenges towards development. *Stud, 5(2)*.
- Islam, M., & Rahman, M. (2015). Promoting Bangladesh Labor Law to Managing Human Resources in Enterprises-Perspectives & Challenges. *International Journal of Advances in Management and Economics, 4*.
- Islam, N., & Chowdhuri, A. S. M. M. B. (2012). Socioeconomic factors of readymade garments workers in Bangladesh. *D. U. Journal of Marketing, 15*.
- Islam, S. (2017). Gender Difference-How Does it Affect Trade Union Struggle? A Qualitative Study on Female Workers of Bangladeshi RMG Industries. *Socioeconomica-Naučničasopis zateorijui praksudruštveno-ekonomskog razvoja, 6(12)*, 165-178.
- Islam, S. S. (1985). The Role of the State in the Economic Development of Bangladesh during the Mujib Regime (1972-1975). *The Journal of Developing Areas, 19(2)*, 185-208.

- Ismail, M., Alias, S. N., & Rasdi, R. M. (2015). Community as stakeholder of the corporate social responsibility programme in Malaysia: Outcomes in community development. *Social Responsibility Journal*, *11*(1), 109–130.
- Jackson, M. P., Leopold, J. W., Tuck, K., & Shams, S. R. (2016). *Decentralization of Collective Bargaining: An Analysis of Recent Experience in the UK*. Springer.
- Jacoby, S. M. (2018). *The embedded corporation: Corporate governance and employment relations in Japan and the United States*. Princeton University Press.
- Jakobsen, M., & Jensen, R. (2015). Common method bias in public management studies. *International Public Management Journal*, *18*(1), 3-30.
- Jarvis, C. B., MacKenzie, S. B., & Podsakoff, P. M. (2003). A critical review of construct indicators and measurement model misspecification in marketing and consumer research. *Journal of consumer research*, *30*(2), 199-218.
- Jensen, C., & Meckling, H. (1976). Ttheory of the firm: Managerial behaviour, agency costs and ownership structure, *3*, 305–360.
- Jewer, J., & McKay, K. N. (2012). Antecedents and consequences of board IT governance: Institutional and strategic choice perspectives. *Journal of the Association for Information Systems*, *13*(7), 1.
- Jiang, B. (2009). Implementing supplier codes of conduct in global supply chains: Process explanations from theoretic and empirical perspectives. *Journal of business ethics*, *85*(1), 77-92.
- Johanson, G. A., & Brooks, G. P. (2010). Initial scale development: sample size for pilot studies. *Educational and psychological measurement*, *70*(3), 394-400.
- Johansson, M., & Partanen, T. (2002). Role of trade unions in workplace health promotion. *International journal of health services*, *32*(1), 179-193.
- Johnson, R. B., & Onwuegbuzie, A. J. (2004). Mixed methods research: A research paradigm whose time has come. *Educational researcher*, *33*(7), 14-26.
- Johnson, R. B., Onwuegbuzie, A. J., & Turner, L. A. (2007). Toward a definition of mixed methods research. *Journal of mixed methods research*, *1*(2), 112-133.
- Johnson, T., & Owens, L. (2002). Survey response rate reporting in the professional literature. *American Association for Public Opinion Research - Section on Survey Research Methods*, 127–133.
- Johnston, H., & Land-Kazlauskas, C. (2018). Organizing on-demand: Representation, voice, and collective bargaining in the gig economy. *Conditions of work and employment series*, *94*.

- Joo, S., Larkin, B., & Walker, N. (2017). Institutional isomorphism and social responsibility in professional sports. *Sport, Business and Management: An International Journal*, 7(1).
- Kabeer, N., Haq, L., & Sulaiman, M. (2019). *Multi-stakeholder initiatives in Bangladesh after Rana Plaza: Global norms and workers' perspectives* (No. 19-193). Working Paper Series.
- Kabir, H., Maple, M., & Fatema, S. R. (2018). Vulnerabilities of women workers in the readymade garment sector of Bangladesh: A case study of Rana Plaza. *Journal of International Women's Studies*, 19(6), 224-235.
- Kabir, M., Singh, S., & Ferrantino, M. J. (2019). *The Textile-Clothing Value Chain in India and Bangladesh: How Appropriate Policies Can Promote (or Inhibit) Trade and Investment*. The World Bank.
- Kabir, M.M., Uddin, M.S. & Akter, N. (2018). Effect of Some Factors of Organizational Culture In Retaining Employees in Readymade Garments Industries in Bangladesh: An Observation, *Stamford Journal of Business Studies*.
- Kahn-Freund, O. (1967). A note on status and contract in British labour law. *The Modern Law Review*, 30(6), 635-644.
- Kaium, A. (2020). Assessment and Improvement of Safety Climate in Readymade Garment Industry.
- Karmaker, C. L., & Saha, M. (2016). A case study on constraints affecting the productivity of readymade garment (RMG) industry in Bangladesh. *International journal of managing value and supply chains (IJMVSC)*, 7(3), 69-78.
- Katz, H. C., Kochan, T. A., & Gobeille, K. R. (1983). Industrial relations performance, economic performance, and QWL programs: An interplant analysis. *ILR Review*, 37(1), 3-17.
- Kaufman, B. E. (2010). The theoretical foundation of industrial relations and its implications for labor economics and human resource management. *ILR Review*, 64(1), 74-108.
- Kaufman, B. E. (2012). An institutional economic analysis of labor unions. *Industrial Relations: A Journal of Economy and Society*, 51, 438-471.
- Kaufman, B. E. (2013). The economic organization of employment: Systems in human resource management and industrial relations. In *Handbook of Economic Organization*. Edward Elgar Publishing.
- Kaufman, B. E. (Ed.). (2004). *Theoretical perspectives on work and the employment relationship*. Cornell University Press.

- Kays, H. E., Prodhan, S., Karia, N., Karim, A. N. M., & Sharif, S. B. (2019). Improvement of operational performance through value stream mapping and Yamazumi chart: A case of Bangladeshi RMG industry. *Int J Recent TechnolEng*, 8(4), 11977-11986.
- Keane, J., & teVelde, D. W. (2008). The role of textile and clothing industries in growth and development strategies. *Overseas Development Institute, Working Paper*, (May), 1–71.
- Keiser, S., Garner, M. B., & Vandermar, D. (2017). *Beyond design: The synergy of apparel product development*. Bloomsbury Publishing USA.
- Kemp, L. J. (2013). Modern to postmodern management: developments in scientific management. *Journal of Management History*.
- Kersley, B., Alpin, C., Forth, J., Bryson, A., Bewley, H., Dix, G., & Oxenbridge, S. (2013). *Inside the workplace: findings from the 2004 Workplace Employment Relations Survey*. Routledge.
- Khaled, S. M. S. (2010). Problems of Bangladesh Garments Sector and their Solution—An Islamic Perspective. *Thoughts on Economics*, 20(3), 23-50.
- Khan, A. R. (2015). *The Economy of Bangladesh: A Quarter Century of Development*. Springer.
- Khan, M. R. I., & Wichterich, C. (2015). Safety and labour conditions: The accord and the national tripartite plan of action for the garment industry of Bangladesh (Global Labour University Working Paper N. o 38).
- Khan, N. R., Dipti, T. R., Ferdousi, S. K., Hossain, M. Z., Ferdousi, S., Sony, S. A., & Islam, M. S. (2015). Occupational Health Hazards Among Workers of Garment Factories in Dhaka City, Bangladesh. *Journal of Dhaka Medical College*, 24(1), 36-43.
- Khan, S. (2010). Trade unionism and minimum wages issue in the apparel industry. *The Financial Express*, 5.
- Khan, T. H. (2013). Labour and Rights. *State of Labour in Bangladesh: UnnayanOnnesan*.
- Khatri, A., Peerzada, M. H., Mohsin, M., & White, M. (2015). A review on developments in dyeing cotton fabrics with reactive dyes for reducing effluent pollution. *Journal of Cleaner Production*, 87, 50-57.
- Khatun, R. & Shamsuzzaman, M. (2015). Employee's Views on Job Satisfaction : A Study on Garment Industry (AKH Group), Bangladesh, *International Journal of Research in Management & Business Studies*, 2 (2).

- Khatun, T., & Afroze, S. (2019). The Relationship between Gender Equality in Bangladesh and Middle-Income Country Status by 2021. *Australian Academy of Accounting and Finance Review*, 4(2), 66-79.
- Khondker, B. H., Razzaque, A., & Ahmed, N. (2005). Exports, employment and working conditions: emerging issues in the post-MFA RMG industry. *International Labour Office*.
- Klasen, S. (2019). What explains uneven female labor force participation levels and trends in developing countries?. *The World Bank Research Observer*, 34(2), 161-197.
- Kline, R. B. (2011). Principles and practice of structural equation modeling (3. Baskı). *New York, NY: Guilford*.
- Kochan, T. A. (2004). Collective actors in industrial relations: what future?. *Industrielle Beziehungen: Zeitschrift für Arbeit, Organisation und Management*, 11(1/2), 6-14.
- Kochan, T. A., Katz, H. C., & McKersie, R. B. (2018). *The transformation of American industrial relations*. Cornell University Press.
- Kochan, T. A., McKersie, R. B., & Cappelli, P. (1983). Strategic choice and industrial relations theory and practice.
- Kochan, T. A., McKersie, R. B., & Cappelli, P. (1984). Strategic choice and industrial relations theory. *Industrial relations*, 23(1), 16-39.
- Kochan, T. A., McKersie, R. B., & Cappelli, P. (2002). Strategic choice and industrial relations theory. *Industrial Relations: Critical Perspectives on Business and Management*, 23(1), 69.
- Kochan, T., Katz, H., & McKersie, R. (1986). *The Transformation of American Industrial Relations*. New York, Basic Books.
- Kochan, T., Lansbury, R., & Verma, A. (Eds.). (2005). *Employment relations in the growing Asian economies*. Routledge.
- Kohl, H. (2009). Freedom of association, employees' rights and social dialogue in Central and Eastern Europe and the Western Balkans. *Friedrich Ebert Foundation, Warsaw*.
- Kolben, K. (2009). Labor rights as human rights. *Va. J. Int'l L.*, 50, 449.
- Komorita, S. S., & Graham, W. K. (1965). Number of scale points and the reliability of scales. *Educational and Psychological Measurement*, 25(4), 987-995.
- Korajczyk, R. W. (1961). *The Human Relations Approach and Its Critics*.
- Księżak, P. (2016). The CSR challenges in the clothing industry. *Journal of Corporate Responsibility and Leadership*, 3(2), 51-65.

- Kurpad, M. R. (2014). Made in Bangladesh: challenges to the ready-made garment industry. *Journal of International Trade Law and Policy*.
- Kurubetti, A., & Nagendra, A. (2014). Industrial Relations at Cummins India Limited: a Case Study. *Procedia Economics and Finance*, 11, 86-94.
- Kuruville, S., & Zhang, H. (2016). Labor unrest and incipient collective bargaining in China. *Management and Organization Review*, 12(1), 159-187.
- Kuruville, S., & Verma, A. (2006). International labor standards, soft regulation, and national government roles. *Journal of Industrial Relations*, 48(1), 41-58.
- Labowitz, S., & Baumann-Pauly, D. (2014). Business as usual is not an option: supply chains and sourcing after Rana Plaza. *Stern Center for Business and Human Rights*, http://stern.nyu.edu/sites/default/files/assets/documents/con_047408.pdf.
- Lach, D. (2014). Challenges of interdisciplinary research: Reconciling qualitative and quantitative methods for understanding human-landscape systems. *Environmental management*, 53(1), 88-93.
- Laiho, T. (2011). *Agency theory and ownership structure - Estimating the effect of ownership structure on firm performance*. Aalto University.
- Lamb, R., & Kling, R. (2003). Reconceptualizing users as social actors in information systems research. *MIS quarterly*, 197-236.
- Landis, H., & Grossett, L. (2014). *Employment and the Law: A practical guide for the Workplace*. Juta and Company Ltd.
- Latifee, E. H. (2016). RMG sector towards a thriving future. *The Daily Star*.
- Lee, C. H. (2009). *Industrial relations and collective bargaining in China*. Geneva: ILO.
- Leggett, C. J. (2005). *Strategic choice and the transformations of Singapore's industrial relations* (Doctoral dissertation, Griffith University).
- Lester, R. A. (2015). *As unions mature: An analysis of the evolution of American unionism*. Princeton University Press.
- Leung, M. Y., Chong, A., Ng, S. T., & Cheung, M. C. (2004). Demystifying stakeholders' commitment and its impacts on construction projects. *Construction Management & Economics*, 22(7), 701-715.
- Levinson, H. M. (1967). Unionism, concentration, and wage changes: toward a unified theory. *ILR Review*, 20(2), 198-205.

- Lewin, D. (1987). Industrial relations as a strategic variable. *Human Resources and the Performance of the Firm*, 1-41.
- Lewin, D. (2001). 'IR and HR perspectives on workplace conflict: What can each learn from the other?' *Human Resource Management Review*, 11(4), 453–85.
- Lewin, D., & Feuille, P. (1983). Behavioral research in industrial relations. *ILR Review*, 36(3), 341-360.
- Lewis, D. (2011). *Bangladesh: politics, economy and civil society*. Cambridge University Press.
- Li, Q. (2013). A novel Likert scale based on fuzzy sets theory. *Expert Systems with Applications*, 40(5), 1609-1618.
- Lignier, P., Evans, C., & Tran-Nam, B. (2014). Tangled up in tape: The continuing tax compliance plight of the small and medium enterprise business sector. *Austl. Tax F.*, 29, 217.
- Lincoln, J. R., & Boothe, J. N. (1993). Unions and work attitudes in the United States and Japan. *Industrial Relations: A Journal of Economy and Society*, 32(2), 159-187.
- Lindell, M. K., & Whitney, D. J. (2001). Accounting for common method variance in cross-sectional research designs. *Journal of Applied Psychology*, 86(1), 114–121.
- Liu, E., & Hanauer, N. (2011). *The gardens of democracy: A new American story of citizenship, the economy, and the role of government*. Sasquatch Books.
- Lohr, S. L. (2009). *Sampling: design and analysis*. Nelson Education.
- Lowry, P. B., & Gaskin, J. (2014). Partial least squares (PLS) structural equation modeling (SEM) for building and testing behavioral causal theory: When to choose it and how to use it. *IEEE Transactions on Professional Communication*, 57(2), 123–146.
- Lund, D. B. (2003). Organizational culture and job satisfaction. *Journal of business & industrial marketing*.
- Lune, H., & Berg, B. L. (2017). *Qualitative research methods for the social sciences*.
- Mahmud, S. (2010). Why do garment workers in Bangladesh fail to mobilize?. In *In L Thompson & C Tapscott (eds) Citizenship and Social Movements: Perspectives from the Global South*. London: Zed, 10.
- Malinowski, B., Minkler, M., & Stock, L. (2015). Labor unions: A public health institution. *American Journal of Public Health*, 105(2), 261–271.

- Mamun, M. A., & Griffiths, M. D. (2020). PTSD-related suicide six years after the Rana Plaza collapse in Bangladesh. *Psychiatry research*, 287, e112645.
- Mannan, M. A. (2015). *Annual Report on IBBL*. Dhaka Bangladesh.
- Marginson, P., & Galetto, M. (2016). Engaging with flexibility and security: Rediscovering the role of collective bargaining. *Economic and Industrial Democracy*, 37(1), 95-117.
- Marsden, D. (1995). The impact of industrial relations practices on employment and unemployment, Centre for Economic Performance, London School of Economics, Discussion Paper No. 240.
- Marsden, R. (1982). Industrial relations: a critique of empiricism. *Sociology*, 16(2), 232-250.
- Marshall, R. (1992). The future role of government in industrial relations. *Industrial Relations: A Journal of Economy and Society*, 31(1), 31-49.
- Martínez Lucio, M., & Stuart, M. (2011). The state, public policy and the renewal of HRM. *The International Journal of Human Resource Management*, 22(18), 3661-3671.
- Mason, C., & Brown, R. (2014). Entrepreneurial ecosystems and growth oriented entrepreneurship. *Final Report to OECD, Paris*, 30(1), 77-102.
- Masters, M. F., Gibney, R., Shevchuk, I., & Zagenczyk, T. (2008). The state as employer. *The SAGE handbook of industrial relations*. London: Sage, 305-324.
- Masum, M. (2016). The Bangladesh textile-clothing industry: a demand-supply review. *社会システム研究*, 33, 109-139.
- Masum, M. H., Fakir, A. A., & Hossain, M. K. (2017). Industries: A comprehensive study from Bangladesh. *Research Journal of Finance and Accounting*, 8(10).
- Mausumi, N. (2017). Stakeholder Roles In Improving Occupational Health and Safety (OHS): A Case Study of Bangladesh Garment Industry. *International Journal of Business Research and Management*.
- Mausumi, N. (2018). Role of Government in Promoting Corporate Social Responsibility: Analysis of the Bangladesh Ready-made Garment (RMG) Industry. *Global Journal of Management And Business Research*.
- Mausumi, N., & Rahman, M. (2018). Impact of Stakeholder Initiatives: Bangladesh Garment Industry. *SCMS Journal of Indian Management*, 15(2), 31-41.
- Maxcy, S. J. (2003). Pragmatic threads in mixed methods research in the social sciences: The search for multiple modes of inquiry and the end of the philosophy of formalism. *Handbook of mixed methods in social and behavioral research*, (51-89).

- McAlexander, J. H., Kim, S. K., & Roberts, S. D. (2003). Loyalty: The Influences of Satisfaction and Brand Loyalty: The Influences of Satisfaction and Brand Community Integration. *Journal of Marketing Theory and Practice*, 11(4), 1–12.
- McCaghy, C. H., Capron, T. A., Jamieson, J. D., & Carey, S. H. H. (2016). *Deviant behavior: Crime, conflict, and interest groups*. Routledge.
- McCleary, K., Goetzel, R. Z., Roemer, E. C., Berko, J., Kent, K., & De La Torre, H. (2017). Employer and employee opinions about workplace health promotion (wellness) programs: results of the 2015 Harris Poll Nielsen Survey. *Journal of occupational and environmental medicine*, 59(3), 256-263.
- McKersie, R. B., & Cappelli, P. (1984). Strategic choice and industrial relations theory. *Industrial relations*, 23(1), 16-39.
- Meade, J. E. (1972). The theory of labour-managed firms and of profit sharing. *The Economic Journal*, 82(325), 402-428.
- Meline, T., & Wang, B. (2004). Effect-size reporting practices in AJSLP and other ASHA journals, 1999–2003. *American Journal of Speech-Language Pathology*.
- Meltz, N. M. (1993). Industrial relations systems as a framework for organizing contributions to industrial relations theory. *Industrial Relations Theory: Its Nature, Scope and Pedagogy*, 161, 182.
- Messick, S. (1998). Test validity: A matter of consequence. *Social Indicators Research*, 45(1-3), 35-44.
- Meyer, J. W. (2010). World society, institutional theories, and the actor. *Annual review of sociology*, 36, 1-20.
- Mia, A. R. (2016). Rights of women workers in the Ready-Made Garment (RMG) sector of Bangladesh: Law and Practice. *Sonargaon University Journal*, 1(1).
- Mia, S., & Akter, M. (2019). Ready-Made Garments Sector of Bangladesh: Its Growth, Contribution and Challenges. *Economics*, 7(1), 17-26.
- Miah, M. D., & Suzuki, Y. (2018). The Development Discourse in the Context of Bangladesh: An Analytical View. In *Power, Property Rights, and Economic Development* (pp. 41-65). Palgrave Macmillan, Singapore.
- Mian, M. E. U. (2020). *A STUDY ON COMPETITIVENESS OF READY-MADE GARMENTS FOR EXPORT-LED ECONOMIC GROWTH IN BANGLADESH: ISSUES AND CHALLENGES* (Doctoral dissertation, University of Saskatchewan).
- Mian, M. N., & Rashid, M. M. (2014). A Critical Analysis of Legal Aid in Bangladesh. *International Journal of Social Science Research*, 2(1), 141-143.

- Mishra, P., Pandey, C. M., Singh, U., Gupta, A., Sahu, C., & Keshri, A. (2019). Descriptive statistics and normality tests for statistical data. *Annals of cardiac anaesthesia*, 22(1), 67.
- Mizan, A. S. (2018). Continuing the Colonial Legacy in the Legislative Drafting in Bangladesh: Impact on the Legal Consciousness and the Rule of Law and Human Rights. *IJDLR*, 6, 3.
- Moazzem, K. G. (2019). New Minimum Wage of the RMG Sector Addressing the Issues of Non-Compliance in Implementation.
- Moazzem, K. G., & Azim, S. S. (2018). Workers' Organizations in RMG Enterprises: How to Address Institutional Challenges?.
- Mohibullah, A. T. M., Hosen, M., Abir, I. H., Takebira, U. M., Jannat, F., & Shakil, I. K. (2018). Improvement of forward linkage to sustain the global apparel market of Bangladesh. *Journal of Textile Engineering & Fashion Technology*, 4(4).
- Mohiuddin, A. K. (2020). A Pandemic Review of Covid-19 Situation in Bangladesh. *The American Journal of Medical Sciences and Pharmaceutical Research*, 2(05), 38-50.
- Mohiuddin, M. (2008). Bangladesh as an emerging tiger in apparel market: Challenges and strategies. *DIU Journal of Business and Economics*, 3(2).
- Mohiuddin, M. (2014). Labor Management Relations Following the Labor Laws of Ready Made Garments in Bangladesh: The Present Perspective. *IOSR Journal of Business and Management*, 16(3), 32.
- MoLE, <http://mwb.portal.gov.bd/site/page/284c73eb-9dd5-4304-8e48-613336b1b162/->, 2018
- Monappa, (2001), *Industrial Relations*, Tata McGraw-Hill Publishing Company Limited, New Delhi
- Monarch, R. (2018): "It's Not You, It's Me": Prices, Quality and Switching in U.S.- China Trade Relationships," mimeo.
- Monarch, R. & T. Schmidt-Eisenlohr (2017): "Learning and the Value of Trade Relationships," International Finance Discussion Papers 1218.
- Moore, T. T., & Chang, J. C. J. (2006). Ethical decision making in software piracy: Initial development and test of a four-component model. *Mis Quarterly*, 167-180.
- Morgan, D. L. (2007). Paradigms lost and pragmatism regained: Methodological implications of combining qualitative and quantitative methods. *Journal of mixed methods research*, 1(1), 48-76.
- Morris, M. G., & Venkatesh, V. (2000). Age differences in technology adoption decisions: Implications for a changing work force. *Personnel psychology*, 53(2), 375-403.

- Morris, M., & Staritz, C. (2017). Industrial upgrading and development in Lesotho's apparel industry: global value chains, foreign direct investment, and market diversification. *Oxford Development Studies*, 45(3), 303-320.
- Moss, P., & Tilly, C. (2001). *Stories employers tell: Race, skill, and hiring in America*. Russell Sage Foundation.
- Mostafiz, F., & Akter, R. (2016). Role of the government and BGMEA in Improving the Workplace Environment of Garments Factories in Bangladesh, *Daffodil International University Journal of Business and Economics*, 1(1), p. 47-59.
- Müller-Jentsch, W. (2004). Theoretical approaches to industrial relations. *Theoretical Perspectives on Work and the Employment Relationship*. Champaign: Industrial Relations Research Association, 1-40.
- MUNSHI, F. (2018). Do Minimum Wages Reduce Employment? Some Empirical Evidence from Bangladesh. *Bangladesh Development Studies*, 41(3).
- Nahar, L. (2019). *A Study on the Significance of Transport Sector on the Garments Industry in Dhaka City* (Doctoral dissertation, University of Dhaka).
- Nemoto, T., & Beglar, D. (2014). Likert-scale questionnaires. In *JALT 2013 Conference Proceedings* (pp. 1-8).
- Neuman, W. L., & Wiegand, B. (2000). *Criminal justice research methods: Qualitative and quantitative approaches*. Boston: Allyn and bacon.
- Neumayer, E., & De Soysa, I. (2006). Globalization and the right to free association and collective bargaining: An empirical analysis. *World development*, 34(1), 31-49.
- Newhall, S. (2017). Ethical Reform in Bangladesh's Ready Made Garment Industry: Building on the Alliance and the Accord. *Siegel Institute Ethics Research Scholars*, 1(1), 5.
- Nguyen, H. H. D., & Yang, J. (2012). Chinese employees' interpersonal conflict management strategies. *International Journal of Conflict Management*, 23(4), 382 – 412.
- Noe, R. A., Hollenbeck, J. R., Gerhart, B., & Wright, P. M. (2015). Human resource management. *Gaining a Competitive*.
- Nowak, P. (2015). The past and future of trade unionism. *Employee Relations*, 37(6), 683–691.
- Nunnally, J. C. (1978). An overview of psychological measurement. In *Clinical diagnosis of mental disorders* (pp. 97-146). Springer, Boston, MA.
- Nunnally, J. C. (1994). *Psychometric theory 3E*. Tata McGraw-hill education.

- Nur, T. (2019). The Role of Trade Unions in Protecting Rights of Labourers in the Readymade Garments (Rmg) Sector of Bangladesh: A Comparative Analysis of Bangladesh, Chinese and Indian Laws. *Thammasat Business Law Journal*, 9, 73-96.
- Nuruzaman, N., Haque, A., & Azad, R. (2016). Is Bangladeshi RMG sector fit in the global apparel business? Analyses the supply chain management. *The South East Asian Journal of Management*, 53-72.
- Nuruzzaman, M. (2013). *Improving competitiveness of readymade garment (RMG) industry of Bangladesh-Analysis of supply chains* (Doctoral dissertation, Curtin University).
- Nuruzzaman, M. (2015). Improving competitiveness in manufacturing-wholesaling-retailing supply chains. *Sustaining competitive advantage via business intelligence, knowledge management, and system dynamics*, 22, 221-457.
- Nwokocha, I. (2015). Employers and the enhancement of industrial harmony in private sector organizations in Nigeria. *IOSR Journal of Humanities and Social Science*, 20(5), 28-35.
- O'Reilly, S., & Kumar, A. (2016). Closing the loop: An exploratory study of reverse ready-made garment supply chains in Delhi NCR. *International Journal of Logistics Management*, 27(2), 486–510. <https://doi.org/10.1108/IJLM-03-2015-0050>.
- Obisi, C. (2016). Disputes resolution through social dialogue: evidence from Nigerian organizations. *Indian Journal of Industrial Relations*, 58-70.
- Ocampo, J. A. (2007). Industrial Development for the 21st Century: Sustainable Development Perspectives. *Industrial Development for the 21st Century: Sustainable Development Perspectives*, 1–4.
- Oka, C. (2010). Channels of buyer influence and labor standard compliance: the case of Cambodia's garment sector. In *Advances in Industrial and Labor Relations*. Emerald Group Publishing Limited.
- Okaka, E. O. (2005). Government Intervention In Industrial Relations In Nigeria 1861-2004 and The Trade Union Amendment Act 2005. *University of Benin (Unpublished M. Sc. Thesis)*.
- Okaka, E. O., & Eriaguna, E. (2011). Government agents in Nigeria's industrial relations system. *Journal of Research in National Development*, 9(1), 187-192.
- Omotayo, O. A., & Ome-Egeonu, A. L. L. W. E. L. L. (2015). The State in Industrial Relations System: An Impartial or a Biased Party?. *International Journal of Social Sciences and Management Research*, 1, 43-47.
- Omotayo, O. A., & Ome-Ogeonu, A. (2014). Dunlopian Industrial-Relations System. A Myth or Heuristic Device?. *Research on Humanities and Social Sciences*, 4(25).

- Omran, M. A., & Ramdhony, D. (2015). Theoretical perspectives on corporate social responsibility disclosure: a critical review. *International Journal of Accounting and Financial Reporting*, 5(2), 38-55.
- Oswald, A. J., Proto, E., & SgROI, D. (2015). Happiness and productivity. *Journal of Labor Economics*, 33(4), 789-822.
- Pages, C., & Ahsan, A. (2007). *Are all labor regulations equal? Assessing the effects of job security, labor dispute, and contract labor laws in India*. The World Bank.
- Palpacuer, F., Gibbon, P., & Thomsen, L. (2005). New Challenges for Developing Country Suppliers in Global Clothing Chains: A Comparative European Perspective. *World Development*, 33(3), 409–430.
- Paras, M. K., & Curteza, A. (2018). Revisiting upcycling phenomena: a concept in clothing industry. *Research Journal of Textile and Apparel*. 22(1), 46–58.
- Parashar, B. K., & Thakur, S. (2018). The Role of Trade Unions to Sustain Cordial Labor-Management Relations. *International Journal of Research in Social Sciences*, 8(3), 122-146.
- Passey, S. L., & Passi, S. L. (1990). Role of Trade Unions: Need for New Attitudes, Beliefs and Practices. *Indian Journal of Industrial Relations*, 387-392.
- Peng, C. Y. J., Harwell, M., Liou, S. M., & Ehman, L. H. (2006). Advances in missing data methods and implications for educational research. *Real data analysis*, 3178.
- Peng, M. W., & Heath, P. S. (1996). The growth of the firm in planned economies in transition: Institutions, organizations, and strategic choice. *Academy of management review*, 21(2).
- Phillips, R., Freeman, R. E., & Wicks, A. C. (2003). What stakeholder theory is not. *Business ethics quarterly*, 13(4), 479-502.
- Pisano, G. P. (2017). Toward a prescriptive theory of dynamic capabilities: connecting strategic choice, learning, and competition. *Industrial and Corporate Change*, 26(5), 747-762.
- Plowman, D. (1978). Employer Associations: challenges and responses. *Journal of Industrial Relations*, 20(3), 237-262.
- Podsakoff, P. M., MacKenzie, S. B., & Lee, J. (2003). Common Method Biases in Behavioral Research : A Critical Review of the Literature and Recommended Remedies. *Journal of Applied Psychology*, 88(5), 879–903.
- Podsakoff, P. M., MacKenzie, S. B., & Podsakoff, N. P. (2012). Sources of method bias in social science research and recommendations on how to control it. *Annual review of psychology*, 63, 539-569.

- Pohler, D. (2020). Robert B McKersie, A Field in Flux: Sixty Years of Industrial Relations. *Journal of Industrial Relations*, 62(2), 322–324.
- Poole, M. (2013). *Industrial relations: origins and patterns of national diversity* (Vol. 4). Routledge.
- Porter, M. E. (1980). *Competitive Strategy*, New York Free Press.
- Pratt, J. (2008). Hidden Hands in the Market: Ethnographies of Fair Trade, Ethical Consumption, and Corporate Social Responsibility. *Research in Economic Anthropology*, 28, 213–240.
- Preena, R. (2020). Are Trade Unions Suitable for Organizations in the 21st Century?.
- Priyadarshi, P. (2011). Employer brand image as predictor of employee satisfaction, affective commitment & turnover. *Indian Journal of Industrial Relations*, 510-522.
- Pruitt, D. G. (1983). Strategic choice in negotiation. *American Behavioral Scientist*, 27(2), 167-194.
- Pun, N., Chan, C. K. C., & Chan, J. (2010). The role of the state, labour policy and migrant workers' struggles in globalized China. *Global Labour Journal*.
- Purcell, J., & Sisson, K. (1983). *Strategies and practice in the management of industrial relations*.
- Quader, M. A., Wazed, M. A., Aziz, A., & Mojumder, J. C. INDUSTRIAL SICKNESS IN BANGLADESH: AN EMPIRICAL ANALYSIS, International Conference on Mechanical Engineering and Renewable Energy 2013
- Quddus, M. A., & Ahsan, A. N. (2014). A shop-floor kaizen breakthrough approach to improve working environment and productivity of a sewing floor in RMG industry. *Journal of Textile and Apparel, Technology and Management*, 8(4).
- Rabby, M. G. (2019). Value Chain Management of Consumer Knitex Limited.
- Rahim, M. A. (2010). *Managing conflict in organizations*. Transaction Publishers.
- Rahim, M. M. (2017). Improving social responsibility in RMG industries through a new governance approach in laws. *Journal of Business Ethics*, 143(4), 807-826.
- Rahim, M. M., & Islam, S. S. (2019). “Freedom of association” in the Bangladesh garments industry—a policy schizophrenia in labour regulation. *International Labour Review*. doi:10.1111/ilr.12152.
- Rahman, A. (2018). *Women Workers in the Ready-Made Garments Industry in Bangladesh: The Challenges of Empowerment Using Amartya Sen’s Capability Approach* (Doctoral dissertation, Flinders University, College of Humanities, Arts and Social Sciences.).

- Rahman, K. M., & Chowdhury, E. H. (2020). Growth Trajectory and Developmental Impact of Ready-Made Garments Industry in Bangladesh. In *Bangladesh's Economic and Social Progress* (pp. 267-297). Palgrave Macmillan, Singapore.
- Rahman, M. A., & Hossain, M. S. (2010). Compliance practices in garment industries in Dhaka city. *Journal of Business and Technology (Dhaka)*, 5(2), 71-87.
- Rahman, M. H., & Siddiqui, S. A. (2015). Female RMG worker: economic contribution in Bangladesh. *International Journal of Scientific and Research Publications*, 5(9), 1-9.
- Rahman, M. M., & Ara, L. A. (2015). TPP, TTIP and RCEP: implications for South Asian economies. *South Asia Economic Journal*, 16(1), 27-45.
- Rahman, M. M., & Kashem, M. A. (2017). Carbon emissions, energy consumption and industrial growth in Bangladesh: Empirical evidence from ARDL cointegration and Granger causality analysis. *Energy Policy*, 110, 600-608.
- Rahman, M. T., Habibullah, M., & Abdullah-Al-Masum, M. (2017). Readymade garment industry in Bangladesh: Growth, contribution and challenges. *Journal of Economics and Finance*, 8(3), 1-7.
- Rahman, M., Bhattacharya, D., & Moazzem, K. G. (2008). *Bangladesh apparel sector in post MFA era: A study on the ongoing restructuring process*. Centre for Policy Dialogue.
- Rahman, M., Moazzem, K. G., & Hossain, S. S. (2009). *Impact of the global economic crisis on the employment and labour market of Bangladesh: A preliminary assessment*. Centre for Policy Dialogue.
- Rahman, S. (2019). Post-Rana Plaza responses: Changing role of the Bangladeshi government. In *Labor, Global Supply Chains, and the Garment Industry in South Asia* (pp. 131-148). Routledge.
- Rahman, Z., & Langford, T. (2012). Why labour unions have failed Bangladesh's garment workers. *Labour in the global south*, 213.
- Raihan, S., & Khan, S. S. (2020). *Structural transformation, inequality dynamics, and inclusive growth in Bangladesh* (No. wp-2020-44). World Institute for Development Economic Research (UNU-WIDER).
- Rajapakshe, W. (2018). An analysis of major factors affecting labor turnover in the apparel industry in Sri Lanka: Policy Alternations for Solving the Problem. *International Journal of Academic Research in Economics and Management Sciences*, 7(3), 214-231.
- Rajesh, S., & Manoj, P. K. (2015). Politicization of trade unions and challenges to industrial relation in India: a study with a focus on norther Karala. *International Journal of Business Administration and Research Review*, 1(2), 45-57.

- Raju, B. S. N. (2015). Industrial Relations as a strategy for enhancing organizational productivity & performance. *Indian Journal of Industrial Relations*, 162-170.
- Rakib, M. A., & Adnan, A. (2015). Challenges of ready-made garments sector in Bangladesh: Ways to overcome. *BUFT Journal*, 3, 77-90.
- Rasel, M. S., Das, D., & Khan, M. R. (2019). Current Scenario of Textile Sector in Bangladesh, A Comprehensive Review.
- Rashid, F., & Taibb, C. A. (2020). Total Quality Management (TQM) Adoption in Bangladesh Ready-Made Garments (RMG) Industry: A Conceptual Model. *American Journal of Industrial and Business Management*, 6(11), 1085-1101.
- Rashid, M. M., & Rashid, M. A. (2015). Health and Safety Environment of Readymade Garment Industry in Bangladesh: A Case Study of ZaheenKnitwears Limited. *Manarat International University Studies*, 4(1), 71-82.
- Rashid, M. M., Ahmad, S., & Sarkar, M. R. (2014). Compliance of safety, health and welfare in RMG of Bangladesh. *Technology (BUET)*, 1877, 7058.
- Ravenswood, K., & Kaine, S. (2015). The role of government in influencing labour conditions through the procurement of services: Some political challenges. *Journal of Industrial Relations*, 57(4), 544-562.
- Rayhan, S. J., Saha, S., & Hassan, M. M. (2014). Factors Affecting the Customer Buying Behavior in Relation to Readymade Garments in Bangladesh. *International Research Journal of Marketing*, 2(2), 36-42.
- Razzaue, A., Eusuf, A., & Shamannay, U. (2007). Trade, development and poverty linkage: A case study of ready made garment industry in Bangladesh. *UnnayanShamannay*, 4-8.
- Rehman, A. A., & Alharthi, K. (2016). An introduction to research paradigms. *International Journal of Educational Investigations*, 3(8), 51-59.
- Reinhold, K., & Tint, P. (2009). Lighting of workplaces and health risks. *ElektronikairElektrotechnika*, 90(2), 11-14.
- Revathi, R., & Aithal, P. S. (2019). A Review on Impact of Information Communication & Computation Technology (ICCT) on Selected Primary, Secondary, and Tertiary Industrial Sectors.
- Rhee, Y. W. (1990). The catalyst model of development: Lessons from Bangladesh's success with garment exports. *World Development*, 18(2), 333-346.
- Richards, K. (2003). *Qualitative inquiry in TESOL*. New York, NY: Palgrave Macmillan.

- Richardson, H. A., Tehseen, M. J., & Sturman, M. C. (2009). A tale of three perspectives: Examining post hoc statistical techniques for detection and correction of common method variance. *Organizational Research Methods*, 12(4), 762-800.
- Richardson, J. (2013). *An Introduction to the study of Industrial Relations* (Vol. 5). Routledge.
- Rigby, M., & O'Brien-Smith, F. (2010). TU interventions in work-life balance. *Work, Employment and Society*, 24(2), 203-220.
- Robinson, A. M., & Zhang, H. (2005). Employee share ownership: safeguarding investments in human capital. *British Journal of Industrial Relations*, 43(3), 469-488.
- Rock, M. (2001). Globalisation and Bangladesh: The case of export- oriented garment manufacture. *South Asia: Journal of South Asian Studies*, 24(1), 201-225.
- Rodin, L. (2016). 'Developmental talk as confession: The role of trade unions in workplace governance. *ephemera: theory & politics in organization*, 16(2).
- Rogers, J., & Streeck, W. (Eds.). (2009). *Works Councils: consultation, representation, and cooperation in industrial relations*. University of Chicago Press.
- Rogowski, R. (2010). Industrial relations as a social system. *Industrielle Beziehungen/The German Journal of Industrial Relations*, 97-126.
- Rönmar, M. (2019). Autonomous Collective Bargaining in Sweden under Pressure. *Collective Bargaining and Collective Action: Labour Agency and Governance in the 21st Century?*.
- Rose, E. D. (2004). *Employment relations*. Pearson Education.
- Ross, P., & Bamber, G. J. (2009). Strategic choices in pluralist and unitarist employment relations regimes: A study of Australian telecommunications. *ILR Review*, 63(1), 24-41.
- Rossiter, J. R. (2002). The C-OAR-SE procedure for scale development in marketing. *International journal of research in marketing*, 19(4), 305-335.
- Rubya, T. (2015). The Ready-Made Garment Industry: An Analysis of Bangladesh's Labor Law Provisions after the Savar Tragedy. *Brooklyn Journal of International Law*, 40(2), 7.
- Saha, A. K., & Islam, M. S. (2017). Experience in Readymade Garments Export: A Study on Global Context. *The Millennium University Journal*, 2(1), 25-36.
- Saha, P., & Mazumder, S. (2015). Impact of working environment on less productivity in RMG industries: A study on Bangladesh RMG sector. *Global Journal of Management And Business Research*.

- Saini, D. S. (2014). Indian industrial relations law: Case for reform. *THE INDIAN JOURNAL OF INDUSTRIAL RELATIONS*, 118-132.
- Salamon, M. (2000). *Industrial relations: Theory and practice*. Pearson Education.
- Salminen, J. (2018). The accord on fire and building safety in Bangladesh: a new paradigm for limiting buyers' liability in global supply chains?. *The American Journal of Comparative Law*, 66(2), 411-451.
- Samaddar, K. K. (2016). Occupational Health and Safety Management in RMG Sector of Bangladesh. *International journal of scientific & technology research*, 5(12), 176-193.
- Sandelowski, M. (1995). Sample size in qualitative research. *Research in nursing & health*, 18(2), 179-183.
- Sandoval, Z. V. (2016). THE RE-DESIGN PROCESS OF AN INSTRUMENT TO EVALUATE USABILITY IN ONLINE COURSES. *Issues in Information Systems*, 17(3).
- Sarkar, A., Qian, L., & Peau, A. K. (2020). Overview of green business practices within the Bangladeshi RMG industry: competitiveness and sustainable development perspective. *Environmental Science and Pollution Research*, 1-14.
- Sarkar, A., Qian, L., & Peau, A. K. (2020). Structural equation modeling for three aspects of green business practices: a case study of Bangladeshi RMG's industry. *Environmental Science and Pollution Research*, 1-19.
- Sarkar, P., Anjum, A., & Khan, E. A. (2017). Overview of major industries in Bangladesh. *Journal of Chemical Engineering*, 30(1), 51-58.
- Sarker, M. A. R., & Afroze, R. (2014). Can HRM practices improve job satisfaction of Ready Made Garment (RMG) workers in Bangladesh? An alternative solution to recent unrest. *International Journal of Business and Management*, 9(10), 185.
- Sarooshi, D. (2003). The essentially contested nature of the concept of sovereignty: implications for the exercise by international organizations of delegated powers of government. *Mich. J. Int'l L.*, 25, 1107.
- Sarowar, G. (2015). Industrial Dispute Settlement Mechanism and Its Effectiveness in Bangladesh: A Legal Study, *Manarat International University Studies*, 4(1), 103-110.
- Saundry, R., Jones, C., & Antcliff, V. (2011). Discipline, representation and dispute resolution—exploring the role of trade unions and employee companions in workplace discipline. *Industrial Relations Journal*, 42(2), 195-211.
- Schafer, J. L. (1999). Multiple imputation: a primer. *Statistical methods in medical research*, 8(1), 3-15.

- Schlomer, G. L., Bauman, S., & Card, N. A. (2010). Best practices for missing data management in counseling psychology. *Journal of Counseling psychology*, 57(1), 1.
- Schoen, R. F. (2019, July). Women and rural industrialization: Garment production reaches old land and new labor in Bangladesh. In *Women's Studies International Forum* (Vol. 75, p. 102248). Pergamon.
- Scholtz, B., Mahmud, I., Mahmud, I., & Ramayah, T. (2016). Does usability matter? An analysis of the impact of usability on technology acceptance in ERP settings. *Interdisciplinary Journal of Information, Knowledge, and Management*, 11, 309–330.
- Scotland, J. (2012). Exploring the philosophical underpinnings of research: Relating ontology and epistemology to the methodology and methods of the scientific, interpretive, and critical research paradigms. *English language teaching*, 5(9), 9-16.
- Sekaran, U., & Bougie, R. (2016). *Research methods for business: A skill building approach*. John Wiley & Sons.
- Sekiguchi, T. (2005). The strategic choice model and industrial relations in Japan. *Osaka KeidaiRonshu*, 56(4), 91-102.
- Sen, S., Antara, N., Sen, S., & Chowdhury, S. (2020). The apparel workers are in the highest vulnerability due to COVID-19: a study on the Bangladesh Apparel Industry. *Sen S, Antara N, Sen S, Chowdhury S. The apparel workers are in the highest vulnerability due to COVID-19: a study on the Bangladesh Apparel Industry. Asia Pacific J Multidiscip Res*, 8(3).
- Shah, R., & Goldstein, S. M. (2006). Use of structural equation modeling in operations management research: Looking back and forward. *Journal of Operations Management*, 24(2), 148–169.
- Sharma, V. (2015). Imperfect work conditions in Bangladesh RMG sector. *International Journal of Law and Management*, 57(1), 28-37.
- Shaw, J. A., Connelly, D. M., & Zecevic, A. A. (2010). Pragmatism in practice: Mixed methods research for physiotherapy. *Physiotherapy theory and practice*, 26(8), 510-518.
- Shea, A., Nakayama, M., & Heymann, J. (2010). Improving labour standards in clothing factories: Lessons from stakeholder views and monitoring results in Cambodia. *Global Social Policy*, 10(1), 85-110.
- Sheldon, P. (2018). Employers, managers and employment relations. In *The Routledge Companion to Employment Relations* (pp. 199-215). Routledge.
- Sherer, P. D., & Morishima, M. (1989). Roads and roadblocks to dual commitment: Similar and dissimilar antecedents of union and company commitment. *Journal of Labor Research*, 10(3), 311-330.

- Shimu, A. A., & Islam, M. S. (2018). Impacts of macro economic variables on the RMG export growth of Bangladesh. *Economics and Business*, 32(1), 112-125.
- Shirom, A. (1985). The labor relations system: A proposed conceptual framework. *Relations Industrielles/Industrial Relations*, 40(2), 303-323.
- Shoron, A. A. (2015). Workers' Safety in Bangladeshi Readymade Garments Industry.
- Shrestha, B. R. (2012). The effect of trade unionism on workers: A case Study on PAM, 3–86.
- Shumon, M., Rahman, S., & Ahsan, K. (2018). Understanding buyer stringent environmental requirements in the context of sustainable supply chain. In *ISL 2018: Big Data Enabled Supply Chain Innovations* (pp. 487-497). Nottingham University Business School.
- Shumon, R., Halim, Z., Rahman, S., & Ahsan, K. (2019). How do suppliers address stringent environmental requirements from buyers? An exploratory study in the Bangladesh ready-made garment industry. *International Journal of Physical Distribution & Logistics Management*.
- Siddiqua, S., Chowdhury, M. A. M., & Islam, M. R. (2014). Industrial Relation and Dispute Settlement Procedure in RMG Sector of Bangladesh: A Critical Review. *International Journal of Innovation and Applied Studies*, 9(3), 1233.
- Siddiqui, J., & Uddin, S. (2016). Human rights disasters, corporate accountability and the state: Lessons learned from Rana Plaza. *Accounting, Auditing and Accountability Journal*, 29(4), 679–704.
- Siddiqui, J., Mehjabeen, M., & Rahman, S. S. (2019). Accountability and labour governance in a 'State of denial'. In *The Routledge Companion to Accounting in Emerging Economies* (pp. 221-232). Routledge.
- Siltaoja, M. E. (2006). Value priorities as combining core factors between CSR and reputation—a qualitative study. *Journal of Business Ethics*, 68(1), 91-111.
- Silvia, S. J., & Schroeder, W. (2007). Why are German employers associations declining? Arguments and evidence. *Comparative Political Studies*, 40(12), 1433-1459.
- Simmering, N. (2015). Common method bias in PLS-SEM: A full collinearity assessment approach. *International Journal of e-Collaboration (ijec)*, 11(4), 1-10.
- Simms, M. (2015). Union organizing as an alternative to partnership. Or what to do when employers can't keep their side of the bargain. *Finding a voice at work*, 127-152.
- Singh, P. (2015). An Exploratory Study On Factors Affecting Industrial Relation With Reference To Employees Morale And Productivity. *International Journal of Recent Scientific Research*, 6(7), 5128-5130.

- Sinha, P. R. N., Sinha, I. B., & Shekhar, S. P. (2017). *Industrial Relations, Trade Unions and Labour Legislation*. Pearson Education India.
- Sinkovics, N., Hoque, S. F., & Sinkovics, R. R. (2016). Rana Plaza collapse aftermath: are CSR compliance and auditing pressures effective?. *Accounting, Auditing & Accountability Journal*, 29(4), 617-649.
- Sisson, K. (2008). *Putting the record straight: industrial relations and the employment relationship* (No. 88). Warwick Papers in Industrial Relations.
- Sittha, P. V. (2012). Governance and Poverty Reduction in Thailand. *Modern Economy*, 03(05), 487-497.
- Sivarethinamohan, R. (2010). *Industrial relations and labour welfare: Text and cases*. PHI Learning Pvt. Ltd.
- Smith, C. (2012). The short overview of the labour process perspective and history of the International Labour Process Conference. In *International Labour Process Conference, Leeds*.
- Snape, E., Redman, T., & Chen, A. W. (2000). Commitment to the union: a survey of research and the implications for industrial relations and trade unions. *International Journal of Management Reviews*, 2(3), 205-230.
- Sobhan, R. (2014). Bangladesh's Disaster: Perspectives on the Political Economy'. *Indian Review of Global Affairs*, 20.
- Soper, D.S. (2020). A-priori Sample Size Calculator for Structural Equation Models [Software]. Available from <http://www.danielsoper.com/statcalc>
- Stansbury, J. D. (2008). Organized Workers and the Making of Los Angeles, 1890-1915.
- Stefanović, G. (2012). Role of trade unions in the prevention of mobbing (or bullying). *SEER: Journal for Labour and Social Affairs in Eastern Europe*, 401-411.
- Stein, A. A. (1999). The limits of strategic choice: Constrained rationality and incomplete explanation. *Strategic choice and international relations*, 197-228.
- Streeck, W. (1987). The uncertainties of management in the management of uncertainty: Employers, labor relations and industrial adjustment in the 1980s. *Work, employment and Society*, 1(3), 281-308.
- Su, Y. (2017). Taylor scientific management theory carding and significance of organization management. *Social Sciences*, 6(4), 102-107.
- Suen, L. J. W., Huang, H. M., & Lee, H. H. (2014). A comparison of convenience sampling and purposive sampling. *Hu Li ZaZhi*, 61(3), 105.
- Sugihara, K. (2013). Labour-intensive industrialization in global history: An interpretation of East Asian experiences. In *Labour-intensive industrialization in global history*, 34-78). Routledge.

- Summers, C. W. (2000). Employment at will in the United States: The divine right of employers. *U. Pa. J. Lab. & Emp. L.*, 3, 65.
- Sytsma, T. (2019). Rules of Origin Liberalization with Multi-Product Firms: Theory and Evidence from Bangladeshi Apparel Exporters. *Available at SSRN 3452286*.
- Taghizadeh, S. K., Krishnaswamy, J., Rahman, S. A., & Quazi, A. (2017). Service Innovation Management Practices and Pricing Practices for Performance in Malaysian Telecom. *Asian Academy of Management Journal*, 22(2), 129–155.
- Taher, M. A. (1999). Politicization of Trade Unions: Issues and challenges in Bangladesh perspective. *Indian Journal of Industrial Relations*, 403-420.
- Taneja, S., Pryor, M. G., & Toombs, L. A. (2011). Frederick W. Taylor's scientific management principles: Relevance and validity. *Journal of Applied Management and Entrepreneurship*, 16(3), 60.
- Tapia, M., Ibsen, C. L., & Kochan, T. A. (2015). Mapping the frontier of theory in industrial relations: the contested role of worker representation. *Socio-Economic Review*, 13(1), 157-184.
- Taplin, I. M., & Winterton, J. (2004). The European clothing industry: Meeting the competitive challenge. *Journal of Fashion Marketing and Management: An International Journal*, 8(3), 256–261.
- Tarannum, T., & Ansary, M. A. (2018). Safety in RMG sector: performance and progress of DIFE after Rana Plaza. *Safety in Garment Industry*, 2.
- Tashakkori, A., & Creswell, J. W. (2007). Exploring the nature of research questions in mixed methods research.
- Tehseen, S., Ramayah, T., & Sajilan, S. (2017). Testing and controlling for common method variance: A review of available methods. *Journal of Management Sciences*, 4(2), 142-168.
- Thabane, L., Ma, J., Chu, R., Cheng, J., Ismaila, A., Rios, L. P., & Goldsmith, C. H. (2010). A tutorial on pilot studies: the what, why and how. *BMC medical research methodology*, 10(1), 1. the UK, 1976–2014. *Journal of Industrial Relations*, 61(1), 11-32.
- Thompson, E. P. (2016). *The making of the English working class*. Open Road Media.
- Thompson, P., & Newsome, K. (2004). Labor process theory, work, and the employment relation. *Theoretical perspectives on work and the employment relationship*, 2004, 133-62.
- Thurley, K., & Wood, S. (1983). *Industrial relations and management strategy* (Vol. 4). CUP Archive.

- Tiberti, M., Stefani, G., & Lombardi, G. (2016). Efficiency and Capital Structure in the Italian Cereal Sector. *International Journal of Food System Dynamics*, 442–447.
- Traxler, F. (1999). The state in industrial relations: A cross-national analysis of developments and socioeconomic effects. *European Journal of Political Research*, 36(1), 55-85.
- Traxler, F. (2004). Employer associations, institutions and economic change: a crossnational comparison. *IndustrielleBeziehungen/The German Journal of Industrial Relations*, 42-60.
- Trentelman, C. K., Irwin, J., Petersen, K. A., Ruiz, N., & Szalay, C. S. (2016). The case for personal interaction: Drop-off/pick-up methodology for survey research. *Journal of Rural Social Sciences*, 31(3), 4.
- Treu, T. (Ed.). (2013). *Participation in public policy-making: the role of trade unions and employers' associations*. Walter de Gruyter.
- Tsoi, J. (2010). Stakeholders' perceptions and future scenarios to improve corporate social responsibility in Hong Kong and Mainland China. *Journal of business ethics*, 91(3), 391-404.
- Turnbull, P., Blyton, P., Mcgurk, J., & Lucio, M. M. (2000). Strategic Choice and Industrial Relations: A Case Study of British Airways.
- Uddin, M. (2014). How Bangladeshi Ready Made Garments Industry can be competitive in the global Market.
- Uddin, M. (2014). Role of Labour Administration Departments in Protecting Labour Rights: Bangladesh Perspective. *Indian JL & Just.*, 5, 47.
- Uddin, M., & Tangem, S. (2015). A Study on the Relationship between Working Environment and Labor Unrest in Ready-Made Garment (RMG) Industry of Bangladesh. *International Journal of Management Sciences and Business Research*, 4.
- Uddin, M.S. & Jahed, A.M. (2007). "Garments Industry: A Prime Mover of the Socio Economic Development of Bangladesh", *The Cost and Management*, 35(1), 59-70.
- Ullah, A. (2015). Garment Industry in Bangladesh: An Era of Globalization and Neo-Liberalization. *Middle East Journal of Business*, 55(2031), 1-13.
- Ullah, A. (2016). Is Marxism Still Valid in Industrial Relations Theory?. *Middle East Journal of Business*, 55(3034), 1-6.
- Ullah, N., Sunny, M. M. A., & Rahman, M. H. (2013). Compliance Management Practices on Readymade Garment Industry in Bangladesh: An Exclusive Study. In *9th Asian Business Research Conference* (1-9).

- Ungku Abdul Aziz, U. A. H. (1967). Government and industrial relations in Malaysia.
- Upadhyay, K. K., & Pandey, A. C. (2016). Occupational exposure and awareness of occupational safety and health among cloth dyeing workers in Jaipur India. *Iranian Journal of Health, Safety and Environment*, 3(2), 540-546.
- Uzoh, B. C. (2015). The Role of Government in the Industrial Relations System and Wage Related Industrial Unrest in the Public Service in Nigeria, *International Journal of Current Innovation Research*, 1 (2), 23-29.
- Van Buren III, H. J. (2005). An employee-centered model of corporate social performance. *Business Ethics Quarterly*, 687-709.
- Van Buren, H. J., & Greenwood, M. (2011). Bringing stakeholder theory to industrial relations. *Employee Relations*.
- Van Kaam, A. L. (1959). Phenomenal analysis: Exemplified by a study of the experience of "really feeling understood." *Journal of Individual Psychology*, 15, 66-72.
- Vaughn, L., Balch, A., Johns, J., & Currie, S. (2019). Transparency in supply chains and the lived experiences of workers and their families in the garment sectors of Bangladesh and Myanmar. *Journal of the British Academy*, 7(s1), 35-60.
- Venn, D. (2009). Legislation, collective bargaining and enforcement: Updating the OECD employment protection indicators.
- Verma, A., Kochan, T.A. & Lansbury, R.D. (eds). 1995. *Employment Relations in the Changing Asian Economies*. Londong: Routledge.
- Visser, J. (2016). What happened to collective bargaining during the great recession?. *IZA Journal of Labor Policy*, 5(1), 9.
- Waiganjo, E. W. (2012). A critical evaluation of the applicability of unitarism perspective in contemporary employment relations.
- Wallerstein, M., Golden, M., & Lange, P. (1997). Unions, employers' associations, and wage-setting institutions in Northern and Central Europe, 1950–1992. *ILR Review*, 50(3), 379-401.
- Wardell, M. L., Steiger, T. L., & Meiksins, P. (Eds.). (1999). *Rethinking the labor process*. SUNY Press.
- Waters, R. D., Bortree, D. S., & Tindall, N. T. (2013). Can public relations improve the workplace? Measuring the impact of stewardship on the employer-employee relationship. *Employee relations*.
- Werts, C. E., Linn, R. L., & Jöreskog, K. G. (1974). Intraclass reliability estimates: Testing structural assumptions. *Educational and Psychological measurement*, 34(1), 25-33.

- Westland, J. C. (2010). Lower bounds on sample size in structural equation modeling. *Electronic commerce research and applications*, 9(6), 476-487.
- White, R. G., Lansky, A., Goel, S., Wilson, D., Hladik, W., Hakim, A., & Frost, S. D. (2012). Respondent driven sampling-where we are and where should we be going?.
- Whittington, R. (1988). Environmental structure and theories of strategic choice. *Journal of Management studies*, 25(6), 521-536.
- Wibberley, G., Bennett, T., Jones, C., & Hollinrake, A. (2018). The role of trade unions in supporting victims of domestic violence in the workplace. *Industrial Relations Journal*, 49(1), 69-85.
- Wilkinson, B. (2020). *Labour and industry in the Asia-Pacific: lessons from the newly-industrialized countries* (Vol. 54). Walter de Gruyter GmbH & Co KG.
- Williams, S., & Adam-Smith, D. (2010). *Contemporary employment relations: a critical introduction*. Oxford University Press.
- Wirtz, B. W., & Birkmeyer, S. (2015). Open government: Origin, development, and conceptual perspectives. *International Journal of Public Administration*, 38(5), 381-396.
- Wolfe, E. W., & Smith, J. E. (2007). Instrument development tools and activities for measure validation using Rasch models: part II--validation activities. *Journal of applied measurement*, 8(2), 204-234.
- Woolfson, C., Calite, D., & Kallaste, E. (2008). Employee 'voice 'and working environment in post-communist New Member States: an empirical analysis of Estonia, Latvia and Lithuania. *Industrial Relations Journal*, 39(4), 314-334.
- Worker Driven Social Responsibility Network (WDSRN), 2019
- Wyverkens, E., Provoost, V., Ravelingien, A., De Sutter, P., Pennings, G., & Buysse, A. (2014). Beyond sperm cells: a qualitative study on constructed meanings of the sperm donor in lesbian families. *Human Reproduction*, 29(6), 1248-1254.
- Xi, J. (2019). Employee Relations and Harmony in China. In *International Comparative Employee Relations*. Edward Elgar Publishing.
- Yang, Y., & Mlachila, M. (2007). The end of textiles quotas: A case study of the impact on Bangladesh. *The Journal of Development Studies*, 43(4), 675-699.
- Yasmin, A. & Shoru, S., (2017). The Industrial Relation in Bangladesh and India: A Comparative Analysis.
- Yin, R. 2003. Case Study Research: Design and Method. London: Sage Publications.

- Yunus, M., & Yamagata, T. (2012). The garment industry in Bangladesh. *Dynamics of the Garment Industry in Low-Income Countries: Experience of Asia and Africa (Interim Report)*. ChousakenkyuHoukokusho, IDE-JETRO, 6, 29.
- Yvonne Feilzer, M. (2010). Doing mixed methods research pragmatically: Implications for the rediscovery of pragmatism as a research paradigm. *Journal of mixed methods research*, 4(1), 6-16.
- Zaid, M. K. S. A., & Al-Manasra, E. A. (2013). The Impact of Corporate Social Responsibility Dimensions on Organizational Attractiveness in Jordanian Commercial Banks. *European Journal of Business and Management*, 5(12), 175-183.
- Zeitlin, J. (1987). From labour history to the history of industrial relations. *Economic History Review*, 159-184.
- Zhou, Q., Li, Q., & Gong, S. (2019). How Job Autonomy Promotes Employee's Sustainable Development? A Moderated Mediation Model. *Sustainability*, 11(22), 6445.
- Zhu, Q., Liu, J., & Lai, K. H. (2015). Corporate social responsibility practices and performance improvement among Chinese national state-owned enterprises. *International Journal of Production Economics*, 171, 417-426.

APPENDIX-A

Semi-structured questionnaire for the qualitative part

Interview questionnaire

The primary objective of this interview is to understand the perceptions of the actors i.e. trade union leaders, employers, government agents and international buyers as well their roles and relationships with industrial relations in RMG industry of Bangladesh.

Introductory questions

Your name.....

Years of Experience.....

Your present position, duties and responsibilities.....

Main question:

1. What is your opinion regarding the roles of trade unions in industrial relations in RMG industry of Bangladesh?

Probing questions:

- i. What do you think of having trade unions in RMG industry of Bangladesh?
- ii. Do trade unions play proper roles in practicing labor laws in the RMG industry? How?
- iii. What is your opinion about the work environment in the RMG industry?
- iv. Can you tell me about the freedom of association in RMG industry?
- v. Do parties of the industry have confidence in the power of trade unions in collective bargaining?
- vi. How does RMG use trade unions to settle dispute?
- vii. How do trade unions play roles to turn the RMG industry into a safe place to work?

Main question:

2. What do you think about the roles of employers in industrial relations in RMG industry of Bangladesh?

Probing questions:

- i. Do the employers give employees the opportunity to work under labor law?
- ii. Do you think that the employers arrange all kinds of work environments to work in the industry?
- iii. Are employers interested to allow the employees in forming trade unions? Why?
- iv. What kind of attitude do the employers have towards collective bargaining in RMG?
- v. What kind of steps do the employers take to resolve the conflict in the RMG?
- vi. Does the employers encourage to follow buyers' compliance? How?
- vii. Do you think that the employers' values and activities in the industry seem to be the same?
- viii. Do the employers think the employees problems are their own problems?

Main question:

3. What roles government agents do play in industrial relations in RMG industry of Bangladesh?

Probing questions:

- i. How does a government agent assist all actors in the RMG industry in practicing labor law?
- ii. Could you please tell me what measures the government agent takes to protect the working environment in the RMG industry?
- iii. What is your opinion regarding the government agent's view towards forming association in RMG industry?
- iv. Are government agents satisfied with the opportunity for collective bargaining in RMG?
- v. What roles does the government agent play to resolve the dispute in the RMG?
- vi. In the RMG industry, what are responses of government agents relating to the maintenance of buyers' codes of conducts?
- vii. What is your opinion regarding the support by the officials of RMG to the government agents?

Main question:

4. What roles do the foreign buyers play towards industrial relations in RMG industry of Bangladesh?

Probing questions:

- i. The foreign buyers bound the all parties to practice labor laws in the RMG. Do you agree? Why?
- ii. What types of steps do the foreign buyers take to ensure the safety of everyone in the work environment?
- iii. What are the foreign buyers' opinion regarding the formation of associations in RMG?
- iv. How do foreign buyers react regarding the collective bargaining in RMG industry?
- v. Have foreign buyers anything to do to settle the dispute among the actors in RMG?
- vi. What are the foreign buyers opinions regarding the following of their compliance in RMG industry of Bangladesh?

Main questions:

5. What is your perception about the industrial relations situations in your industry?

Probing questions:

- i. What do you think regarding the labor law practices in your industry?
- ii. Please put your opinion about the working environment of your industry.
- iii. What is your opinion regarding the collective bargaining situation in your industry?
- iv. Can you please put your experience regarding the conflict dissolution procedure in your industry?
- v. Does your industry provide freedom to the employees to form their associations?
- vi. What is your observation regarding in maintaining the buyers' compliacee in your industry?
- vii. What is your views regarding the work principles and activities in your industry?

সাক্ষাৎকার প্রশ্নাবলী:

এই সাক্ষাৎকারের উদ্দেশ্য বাংলাদেশ তৈরী পোষাক শিল্পের এ্যাক্টরবৃন্দের (ট্রেড ইউনিয়ন নিয়োগকর্তা, সরকারের এজেন্ট, বিদেশি ক্রেতা) মধ্যে শিল্প সম্পর্ক জানা এবং অনুসন্ধান করা।

পরিচিতি বিষয়ক প্রশ্ন:

আপনার নাম.....

অভিজ্ঞতার বছর.....

আপনার বর্তমান পদবী, কর্তব্য এবং দায়িত্ব.....

মূল প্রশ্ন:

ক. বাংলাদেশের তৈরি পোষাক শিল্পে শিল্প সম্পর্কের ক্ষেত্রে ট্রেড ইউনিয়নের ভূমিকা সম্পর্কে আপনার মতামত কি?

অনুসন্ধানমূলক প্রশ্ন:

১. বাংলাদেশের তৈরি পোষাক শিল্পে ট্রেড ইউনিয়ন থাকার বিষয়টিকে আপনি কীভাবে দেখেন?
২. তৈরি পোষাক শিল্পে শ্রম আইন প্রয়োগে ট্রেড ইউনিয়ন কি যথাযথ ভূমিকা পালন করে? কীভাবে?
৩. তৈরি পোষাক শিল্পে কাজের পরিবেশ সম্পর্কে আপনার মতামত কী?
৪. তৈরি পোষাক শিল্পে ট্রেড ইউনিয়ন গঠনের স্বাধীনতা প্রসঙ্গে আপনার মতামত কী?
৫. তৈরি পোষাক শিল্পে যৌথ দরকষাকষিতে ট্রেড ইউনিয়নের ক্ষমতার ওপর পক্ষসমূহের আস্থা রয়েছে কী?
৬. তৈরি পোষাক শিল্পে ট্রেড ইউনিয়নকে দ্বন্দ্ব মিটানোর জন্য কীভাবে ব্যবহার করা হয়?
৭. তৈরি পোষাক শিল্পকে কাজের নিরাপদ স্থানে পরিণত করতে কীভাবে ট্রেড ইউনিয়নগুলি ভূমিকা পালন করে?

মূল প্রশ্ন:

খ. বাংলাদেশের তৈরি পোষাক শিল্পে শিল্প সম্পর্কের ক্ষেত্রে নিয়োগকর্তাদের ভূমিকার বিষয়ে আপনার মতামত সম্পর্কে জানতে চাই।

অনুসন্ধানমূলক প্রশ্ন:

১. মালিকপক্ষ কী শ্রম আইনানুযায়ী কর্মীদের কাজ করতে সুযোগ প্রদান করেন?
২. আপনি কি মনে করেন যে মালিকপক্ষ শিল্পে কাজ করার জন্য সব ধরনের কর্ম পরিবেশের ব্যবস্থা করেন?
৩. মালিকপক্ষ কি ট্রেড ইউনিয়ন গঠন করতে দিতে আগ্রহী? কেন?
৪. মালিক প্রতিষ্ঠানে যৌথ দরকষাকষি বিষয়ে কী ধরনের মনোভাব পোষণ করেন?
৫. মালিক শিল্পে দ্বন্দ্ব মিটানোর জন্য কী ধরনের পদক্ষেপ গ্রহণ করেন?
৬. মালিক কি শিল্পে ক্রেতাদের কম্প্লাইন্স অনুসরণে উৎসাহিত করেন? কীভাবে?
৭. শিল্পে মালিকের মূল্যবোধ এবং কর্মকাণ্ড কী একই রকম বলে আপনি মনে করেন?
৮. মালিক কী ট্রেড ইউনিয়নের সমস্যাকে নিজের সমস্যা মনে করেন?

মূল প্রশ্ন:

গ. বাংলাদেশের তৈরি পোষাক শিল্পে শিল্প সম্পর্কের ক্ষেত্রে সরকারী এজেন্টরা কী ধরনের ভূমিকা পালন করেন?

অনুসন্ধানমূলক প্রশ্ন :

১. সরকারের এজেন্টরা তৈরি পোষাক শিল্পে কীভাবে সকল পক্ষসমূহকে শ্রম আইন অনুশীলনের সহায়তা প্রদান করেন?
২. আপনি কী বলতে পারবেন, তৈরি পোষাক শিল্পে কাজের পরিবেশ রক্ষার জন্য সরকারী এজেন্টরা কী ব্যবস্থা গ্রহণ করেন?
৩. তৈরি পোষাক শিল্পে ট্রেড ইউনিয়ন গঠনের বিষয়ে সরকারী এজেন্টের দৃষ্টিভঙ্গি সম্পর্কে আপনার মতামত কী?
৪. সরকারী এজেন্টরা কী তৈরি পোষাক শিল্পে যৌথ দরকষাকষির সুযোগের বিষয়ে সন্তুষ্ট?
৫. তৈরি পোষাক শিল্পে বিরোধ নিষ্পত্তির জন্য সরকারী এজেন্ট কী ভূমিকা পালন করেন?
৬. তৈরি পোষাক শিল্পে ক্রেতাদের কম্প্লাইন্স রক্ষণাবেক্ষণ সম্পর্কিত সরকারী এজেন্টদের প্রতিক্রিয়া কী?
৭. তৈরি পোষাক শিল্পের কর্তৃপক্ষের প্রতি সরকারী এজেন্টদের সহযোগিতা সম্পর্কে আপনার মতামত কী?

মূল প্রশ্ন:

ঘ. বাংলাদেশের তৈরি পোষাক শিল্পে শিল্প সম্পর্কে বিদেশি ক্রেতারা কী ধরনের ভূমিকা পালন করেন?

অনুসন্ধানমূলক প্রশ্ন :

১. বিদেশি ক্রেতারা তৈরি পোষাক শিল্পে সকল পক্ষকে শ্রম আইন অনুশীলনের জন্য বাধ্য করেন। আপনি কি একমত? কেন?
২. তৈরি পোষাক শিল্পে কার্মপরিবেশে প্রত্যেকের নিরাপত্তা নিশ্চিত করতে বিদেশি ক্রেতারা কী ধরনের পদক্ষেপ গ্রহণ করেন?
৩. তৈরি পোষাক শিল্পে ট্রেড ইউনিয়ন গঠনের বিষয়ে বিদেশি ক্রেতাদের মতামত কী?
৪. তৈরি পোষাক শিল্পে যৌথ দরকষাকষির বিষয়ে বিদেশি ক্রেতাদের প্রতিক্রিয়া কী?
৫. তৈরি পোষাক শিল্পে পক্ষদের মধ্যে বিরোধ নিষ্পত্তির জন্য বিদেশি ক্রেতারা কী কী ভূমিকা পালন করেন?
৬. তৈরি পোষাক শিল্পে কম্প্লাইন্স অনুসরণ সম্পর্কে বিদেশি ক্রেতাদের মতামত কী?

মূল প্রশ্ন :

ঙ. আপনার শিল্পে শিল্প সম্পর্কের পরিস্থিতি সম্পর্কে আপনার মতামত কী?

অনুসন্ধানমূলক প্রশ্ন :

১. আপনার শিল্পে শ্রম আইন অনুশীলন সম্পর্কে আপনি কী মনে করেন?
২. আপনার শিল্পে কাজের পরিবেশ সম্পর্কে আপনার মতামত কী?
৩. আপনার শিল্পে যৌথ দরকষাকষি পরিস্থিতি সম্পর্কে আপনার মতামত কী?
৪. আপনার শিল্পে দ্বন্দ্ব নিরসনের প্রক্রিয়া সম্পর্কে আপনার অভিজ্ঞতার বিষয়ে কিছু জানাবেন কি?
৫. আপনার শিল্পে কী কর্মীদের ইউনিয়ন গঠনের জন্য স্বাধীনতা প্রদান করে?
৬. আপনার শিল্পে ক্রেতাদের কম্প্লাইন্স অনুসরণ করার বিষয়ে আপনার পর্যবেক্ষণ কী?
৭. আপনার শিল্পের কর্মনীতি এবং কার্যকলাপ সম্পর্কিত আপনার মতামত কী?

APPENDIX-B

Structured Questionnaire for the quantitative part

Questionnaire

Dear Respondent

I am a Ph.D. candidate of the Department of Management Studies, University of Rajshahi. I am conducting a study on “*Industrial Relations in Ready-Made Garment Industry of Bangladesh*” as part of my PhD research. The objective of this research is to obtain your valuable input on the investigated roles of the actors of industrial relations and their relationships.

Thank you for agreeing to complete this questionnaire. Your participation in this research is voluntary. The confidentiality and anonymity of the respondents will be respected and protected. I will ensure and guarantee that none of the respondents that cooperate in the research will be identified or be capable of identification in the writing up of the research for academic publication. Any data presented will be aggregated, as I am interested in general trends, not in a particular individual or organization.

Your assistance in completing this questionnaire would be valuable not only to me but would also make an important contribution to our knowledge regarding industrial relations in RMG industry of Bangladesh. I will value your honest response to the questionnaire and your kind participation is greatly appreciated. This study has been approved by the Academic Council and Syndicate of the University of Rajshahi. If needed, verification of approval can be obtained by writing to the Registrar, University of Rajshahi-6205, Bangladesh, phone: +880721-750244. If you need further information about the study, please feel free to contact me. My contact details are provided below. Alternatively, you can contact my supervisors Professor Sheikh M. Nurullah (+8801726-718845) and Professor Dr. A.K.M. Moniruzzaman (+8801712-562578).

Consent to participate

Your involvement in the research is voluntary. You have the right to withdraw from this survey at any stage if you desire.

Please make sure that you have completed all the items listed in these below questionnaire.

Thank you very much for your time and effort to complete this survey.

Yours Sincerely,

Md. Shawan Uddin

Assistant Professor

Ph.D. Candidate

Department of Management Studies

University of Rajshahi-6205, Bangladesh

Cell # 01556-307564, e-mail: shawanmgt@ru.ac.bd

Section: B

<p>Listed below are the statements that measure the relationships between the roles of actors involved and state of industrial relations in RMG industry of Bangladesh.</p> <p>Please read each statement carefully, then indicate the extent to which you disagree or agree by checking the appropriate number on a scale of 1 (Strongly Disagree) to 6 (Strongly agree). Please marks tick (√) the most appropriate answer.</p>	Strongly Disagree	Disagree	Somewhat Disagree	Somewhat agree	Agree	Strongly Agree
	1	2	3	4	5	6

1	I feel a sense of pride of having trade unions.	1	2	3	4	5	6
2	I feel satisfied of labor law practices.	1	2	3	4	5	6
3	Trade unions play roles for effective working environment.	1	2	3	4	5	6
4	I feel the need of freedom of association.	1	2	3	4	5	6
5	I think trade unions play roles in collective bargaining.	1	2	3	4	5	6
6	My industry provides the opportunities to trade unions to solve dispute.	1	2	3	4	5	6
7	Trade unions follow the buyers' codes of conducts properly.	1	2	3	4	5	6
8	Employers encourage to work in accordance with labor laws.	1	2	3	4	5	6
9	Employers ensure almost any type of conditions of working in the industry.	1	2	3	4	5	6
10	Employers encourage freedom of association.	1	2	3	4	5	6
11	Employers interested in collective bargaining process.	1	2	3	4	5	6
12	The employers think the employees problems are their problems.	1	2	3	4	5	6
13	The employers strictly follow buyers' codes of conduct.	1	2	3	4	5	6
14	Employers' values and practices are very similar.	1	2	3	4	5	6
15	Government agents ensure of practicing regulatory framework.	1	2	3	4	5	6
16	Government agents can deal openly with working environment.	1	2	3	4	5	6
17	Government agents always show respect to organizing association.	1	2	3	4	5	6
18	Government agents ensure opportunity for collective bargaining.	1	2	3	4	5	6
19	Government agents assist in dispute resolution.	1	2	3	4	5	6
20	Government agents are keen to follow buyers' codes of conduct.	1	2	3	4	5	6

21	Government agents get all sorts of assistance from the all parties in RMG.	1	2	3	4	5	6
22	Foreign buyers promote regulatory framework practices to protect the unfair.	1	2	3	4	5	6
23	Foreign buyers make sure that everyone is safe in work environment.	1	2	3	4	5	6
24	Foreign buyers encourage all parties to participate in their respective associations.	1	2	3	4	5	6
25	Foreign buyers encourage collective bargaining.	1	2	3	4	5	6
26	Foreign buyers are satisfied in dispute resolution procedure.	1	2	3	4	5	6
27	RMG industries are very much alert to maintain foreign buyers' codes of conduct.	1	2	3	4	5	6

Please marks tick (√) the most appropriate answer of this section based on the following scale.

Strongly disagree	Disagree	Moderately disagree	Somewhat disagree	Somewhat agree	Moderately agree	Agree	Strongly agree
1	2	3	4	5	6	7	8

		1	2	3	4	5	6	7	8
28	My industry practices labor laws.	1	2	3	4	5	6	7	8
29	My industry maintains its working environment accordingly.	1	2	3	4	5	6	7	8
30	My industry acknowledges freedom of association.	1	2	3	4	5	6	7	8
31	In my industry, collective bargaining procedures are followed.	1	2	3	4	5	6	7	8
32	My industry always appreciates dispute resolution.	1	2	3	4	5	6	7	8
33	My industry discloses its buyers' codes of conduct	1	2	3	4	5	6	7	8
34	I have the faith that work policies of my industry are well developed and organized.	1	2	3	4	5	6	7	8

জরিপ প্রশ্নোত্তর পত্র

মহোদয়,

রাজশাহী বিশ্ববিদ্যালয় ম্যানেজমেন্ট স্টাডিজ বিভাগের পিএইচডি প্রোগ্রামের আমি একজন গবেষক। আমার গবেষণা কর্মের শিরোনাম “**Industrial Relations in Ready-Made Garment Industry of Bangladesh**” এই গবেষণার উদ্দেশ্য বাংলাদেশ তৈরী পোষাক শিল্পের এ্যাক্টরবৃন্দের (ট্রেড ইউনিয়ন নিয়োগকর্তা, সরকারের এজেন্ট, বিদেশি ক্রেতা) মধ্যে শিল্প সম্পর্ক জানা এবং অনুসন্ধান করা।

এই জরিপ প্রশ্নোত্তর পত্রটি পূরণে সম্মত হওয়ায় আপনাকে ধন্যবাদ। আমি নিশ্চয়তা প্রদান করছি যে, এই প্রশ্নোত্তরে আপনার মতামত শুধুমাত্র আমার গবেষণার কাজে ব্যবহার করা হবে এবং আপনার মতামত ও পরিচয়ের বিষয়ে গোপনীয়তা বজায় রাখা হবে। এই গবেষণায় উপস্থাপিত তথ্য-উপাত্ত সর্বজনীন স্বার্থ সংশ্লিষ্ট, ইহা কোন সুনির্দিষ্ট ব্যক্তি বা প্রতিষ্ঠান কেন্দ্রিক নয়।

এই জরিপটি পূরণের মাধ্যমে আপনার মতামত ও তথ্য-উপাত্ত আমার গবেষণা কাজের সহায়কের সংগে সংগে বাংলাদেশের তৈরী পোষাক শিল্প সংক্রান্ত আরও জ্ঞান সমৃদ্ধিতে অবদান রাখবে। এই জরিপ পত্রে আপনার অংশগ্রহণ এবং মতামতের প্রতি আমি সর্বোচ্চ মূল্যায়ণ প্রদান করব। এই গবেষণাটি রাজশাহী বিশ্ববিদ্যালয়ের একাডেমিক কাউন্সিল এবং সিন্ডিকেট কর্তৃক অনুমোদিত হয়েছে। প্রয়োজনে বিষয়টি রেজিস্ট্রার, রাজশাহী বিশ্ববিদ্যালয়, রাজশাহী-৬২০৫, বাংলাদেশ, ফোন নং +৮৮০৭২১-৭৫০২৪৪, ফ্যাক্স নং +৮৮০৭২১-৭৫০০৬৪ কর্তৃক যাচাই করা যেতে পারে।

উল্লেখিত জরিপ বা প্রশ্নমালা বা প্রশ্ন সংক্রান্ত আপনার কোন জিজ্ঞাসা থাকলে অনুগ্রহ করে আপনি আমার সংগে যোগাযোগ করতে পারেন। এছাড়াও, প্রয়োজনে আমার সম্মানিত গবেষণা তত্ত্বাবধায়ক প্রফেসর শেখ ম. নূরউল্লাহ (০১৭২৬-৭১৮৮৪৫) ও প্রফেসর ড. এ.কে.এম. মনিরুজ্জামান (০১৭১২-৫৬২৫৭৮) মহোদয়বৃন্দের সংগেও যোগাযোগ করা যেতে পারে।

আপনার বিশ্বস্ত

মো. শাওন উদ্দিন

সহকারী অধ্যাপক

পিএইচডি গবেষক

ম্যানেজমেন্ট স্টাডিজ বিভাগ

রাজশাহী বিশ্ববিদ্যালয়

মোবাইল নম্বর +৮৮ ০১৫৫৬-৩০৭৫৬৪

ই-মেইল-shawanmgt@ru.ac.bd

৯. ফার্মের আকার :

ক. ক্ষুদ্র

খ. মাঝারি

গ. বৃহৎ

পরিচ্ছদ- খ*

<p>নিম্নে বর্ণিত বিবৃতিসমূহ বাংলাদেশের তৈরি পোষাক শিল্পে বিভিন্ন এ্যাক্টরদের ভূমিকার সম্পর্ক এবং শিল্প সম্পর্ক পরিমাপক।</p> <p>দয়া করে প্রতিটি বিবৃতি মনোযোগ সহকারে পড়ুন, তারপরে ১ (দৃঢ়ভাবে অসম্মত) ও ৬ (দৃঢ়ভাবে সম্মত) স্কেলের যথাযথ সংখ্যাটি অনুসারে করে আপনি কতটা অসম্মত বা সম্মত তা নির্দেশ করুন। দয়া করে সবচেয়ে উপযুক্ত উত্তরটিতে (✓) টিক দিন।</p>	দৃঢ়ভাবে অসম্মত	অসম্মত	কিছুটা অসম্মত	কিছুটা সম্মত	সম্মত	দৃঢ়ভাবে সম্মত
	১	২	৩	৪	৫	৬

		১	২	৩	৪	৫	৬
১	ট্রেড ইউনিয়ন থাকার বিষয়ে আমি গর্ব অনুভব করি।	১	২	৩	৪	৫	৬
২	শ্রম আইন প্রয়োগে আমি সন্তুষ্ট।	১	২	৩	৪	৫	৬
৩	ট্রেড ইউনিয়নগুলি কার্যকরী কর্মপরিবেশের জন্য ভূমিকা পালন করে।	১	২	৩	৪	৫	৬
৪	আমি ট্রেড ইউনিয়ন গঠনের স্বাধীনতার প্রয়োজনীয়তা অনুভব করি।	১	২	৩	৪	৫	৬
৫	আমি মনে করি যৌথ দরকষাকষিতে ট্রেড ইউনিয়ন ভূমিকা পালন করে।	১	২	৩	৪	৫	৬
৬	আমার শিল্পে ট্রেড ইউনিয়নকে দ্বন্দ্ব মিটানোর সুযোগ দেওয়া হয়ে থাকে।	১	২	৩	৪	৫	৬
৭	ট্রেড ইউনিয়ন ক্রেতাদের বিধি নিয়ম যথাযথভাবে অনুসরণ করে।	১	২	৩	৪	৫	৬
৮	শ্রম আইনানুযায়ী কর্মীদের কাজ করতে নিয়োগকর্তা উৎসাহ প্রদান করেন।	১	২	৩	৪	৫	৬
৯	শিল্পে কাজ করার জন্য নিয়োগকর্তা যেকোনো ধরনের কর্মপরিবেশের ব্যবস্থা করে থাকেন।	১	২	৩	৪	৫	৬

১০	ট্রেড ইউনিয়ন গঠনে নিয়োগকর্তা উৎসাহ প্রদান করেন।	১	২	৩	৪	৫	৬
১১	যৌথ দরকষাকষি প্রক্রিয়া বিষয়ে নিয়োগকর্তা অত্যন্ত যত্নশীল।	১	২	৩	৪	৫	৬
১২	শ্রমিকের সমস্যাকে নিয়োগকর্তা নিজেদের সমস্যা হিসেবে বিবেচনা করেন।	১	২	৩	৪	৫	৬
১৩	নিয়োগকর্তা ক্রেতাদের নিয়ম নীতি কঠোরভাবে অনুসরণ করেন।	১	২	৩	৪	৫	৬
১৪	নিয়োগকর্তার মূল্যবোধ এবং তাদের কর্মকান্ড অনুরূপ বলে আমি মনে করি।	১	২	৩	৪	৫	৬
১৫	সরকারের এজেন্টরা শ্রম আইন প্রয়োগ নিশ্চিত করেন।	১	২	৩	৪	৫	৬
১৬	সরকারের এজেন্টরা কর্ম পরিবেশ রক্ষায় প্রকাশ্যে ব্যবস্থা গ্রহণ করে থাকেন।	১	২	৩	৪	৫	৬
১৭	সরকারের এজেন্টরা ট্রেড ইউনিয়ন গঠনের প্রতি সম্মান প্রদর্শন করে থাকেন।	১	২	৩	৪	৫	৬
১৮	সরকারের এজেন্টরা যৌথ দরকষাকষির সুযোগ নিশ্চিত করেন।	১	২	৩	৪	৫	৬
১৯	সরকারের এজেন্টরা দ্বন্দ্ব নিরসনে সহযোগিতা প্রদান করে থাকেন।	১	২	৩	৪	৫	৬
২০	সরকারের এজেন্টরা ক্রেতাদের নিয়ম নীতি প্রতিপালনের বিষয়ে দৃষ্টিপাত করে থাকেন।	১	২	৩	৪	৫	৬
২১	সরকারের এজেন্টরা তৈরি পোষাক শিল্পের সকল পক্ষের সহযোগিতা পেয়ে থাকেন।	১	২	৩	৪	৫	৬
২২	বিদেশি ক্রেতারা অন্যায় কর্মকান্ড বিরোধে শ্রম আইন প্রয়োগের আহ্বান প্রকাশ করেন।	১	২	৩	৪	৫	৬
২৩	বিদেশি ক্রেতারা কর্ম পরিবেশে সকলের নিরপত্তা নিশ্চিত করেন।	১	২	৩	৪	৫	৬
২৪	বিদেশি ক্রেতারা সকল পক্ষকে নিজনিজ সংগঠনে অংশ গ্রহণে উৎসাহ প্রদান করে থাকেন।	১	২	৩	৪	৫	৬
২৫	বিদেশি ক্রেতারা যৌথ দরকষাকষির বিষয়ে উৎসাহ প্রদান করে থাকেন।	১	২	৩	৪	৫	৬
২৬	বিদেশি ক্রেতারা দ্বন্দ্ব নিরসনের প্রক্রিয়ার বিষয়ে সন্তুষ্ট।	১	২	৩	৪	৫	৬

২৭	তৈরি পোষাক শিল্পগুলি বিদেশি ক্রেতাদের কম্প্লাইন্স প্রতিপালন বিষয়ে তৎপর।	১	২	৩	৪	৫	৬
----	--	---	---	---	---	---	---

এই অংশে নিম্নোল্লিখিত ভিন্ন স্কেলে দয়া করে সবচেয়ে উপযুক্ত উত্তরটিতে (✓) টিক দিন।

দৃঢ়ভাবে অসম্মত	অসম্মত	মোটামুটি অসম্মত	কিছুটা অসম্মত	কিছুটা সম্মত	মোটামুটি সম্মত	সম্মত	দৃঢ়ভাবে সম্মত
১	২	৩	৪	৫	৬	৭	৮

২৮	আমার শিল্প প্রতিষ্ঠান শ্রম আইনানুযায়ী চলে।	১	২	৩	৪	৫	৬	৭	৮
২৯	আমার শিল্প প্রতিষ্ঠান যথাযথ কর্ম পরিবেশ বজায় রাখে।	১	২	৩	৪	৫	৬	৭	৮
৩০	আমার শিল্প প্রতিষ্ঠান স্বাধীন শ্রমিক সংগঠনের স্বীকৃতি প্রদান করে।	১	২	৩	৪	৫	৬	৭	৮
৩১	আমার শিল্প প্রতিষ্ঠানে যৌথ দরকষাকষি পদ্ধতি অনুসরণ করা হয়।	১	২	৩	৪	৫	৬	৭	৮
৩২	আমার শিল্প প্রতিষ্ঠান সর্বদা দ্বন্দ্ব নিরসনের উৎসাহ প্রদান করে।	১	২	৩	৪	৫	৬	৭	৮
৩৩	আমার শিল্প প্রতিষ্ঠান বিদেশি ক্রেতাদের কম্প্লাইন্স প্রতিপালন সংক্রান্ত বিষয়ে সকলকে অবগত করে থাকে।	১	২	৩	৪	৫	৬	৭	৮
৩৪	আমার শিল্প প্রতিষ্ঠানের কর্মনীতি সুগঠিত ও সুসংহত বলে আমি বিশ্বাস করি।	১	২	৩	৪	৫	৬	৭	৮

APPENDIX C

Descriptive Analysis

I. Demographic Profile of the Respondents

Gender					
		Frequency	Percent	Valid Percent	Cumulative Percent
Valid	Male	233	71.24	71.24	71.24
	Female	94	28.76	28.76	100.0
	Total	327	100.0	100.0	

Age					
		Frequency	Percent	Valid Percent	Cumulative Percent
Valid	20-30 Years	94	28.7	28.7	28.7
	31-40 Years	135	41.3	41.3	70.0
	41-50 Years	81	24.8	24.8	94.8
	50 Years and Above	17	5.2	5.2	100.0
	Total	327	100.0	100.0	

Marital Status					
		Frequency	Percent	Valid Percent	Cumulative Percent
Valid	Unmarried	59	18.0	18.0	18.0
	Married	268	82.0	82.0	100.0
	Total	327	100.0	100.0	

Education					
		Frequency	Percent	Valid Percent	Cumulative Percent
Valid	Below SSC	48	14.7	14.7	14.7
	Below HSC	54	16.5	16.5	31.2
	Below Bachelor	23	7.0	7.0	38.2
	Below Masters	122	37.3	37.3	75.5
	Masters and Above	80	24.5	24.5	100.0
	Total	327	100.0	100.0	

Employment					
		Frequency	Percent	Valid Percent	Cumulative Percent
Valid	Union Leader	111	33.9	33.9	33.9
	Factory Owner	128	39.1	39.1	73.1
	Government Representative	51	15.6	15.6	88.7
	Foreign Buyer	37	11.3	11.3	100.0
	Total	327	100.0	100.0	

Service Type					
		Frequency	Percent	Valid Percent	Cumulative Percent
Valid	Permanent	259	79.2	79.2	79.2
	Temporary	9	2.8	2.8	82.0
	Probationary	22	6.7	6.7	88.7
	Others	37	11.3	11.3	100.0
	Total	327	100.0	100.0	

Experience in RMG Industry					
		Frequency	Percent	Valid Percent	Cumulative Percent
Valid	Less than 2 Years	34	10.4	10.4	10.4
	More than 2 Years to 5 Years	34	10.4	10.4	20.8
	More than 5 Years to 10 Years	135	41.3	41.3	62.1
	More than 10 Years	124	37.9	37.9	100.0
	Total	327	100.0	100.0	

Monthly Salary					
		Frequency	Percent	Valid Percent	Cumulative Percent
Valid	USD 100 - USD 200	42	12.80	12.80	12.80
	USD 200 - USD 300	59	18.0	18.0	30.80
	USD 300 - USD 400	22	6.70	6.70	37.5
	USD 400 - USD 500	9	2.80	2.80	40.40
	USD 500 - USD 600	67	20.5	20.50	60.9
	USD 600 and More	128	39.1	39.10	100.0
	Total	327	100.0	100.0	

Firm Size					
		Frequency	Percent	Valid Percent	Cumulative Percent
Valid	Large Scale	157	48.01	48.01	48.01
	Medium Scale	150	45.87	45.87	93.88
	Small Scale	20	6.12	6.12	100.0
	Total	327	100.0	100.0	

APPENDIX D

Items correlation of the variable:

I. Item Correlation for Trade Unions

Correlations								
		TU1	TU2	TU3	TU4	TU5	TU6	TU7
TU1	Pearson Correlation	1	-.009	.561**	.511**	.443**	.393**	.458**
	Sig. (2-tailed)		.871	.000	.000	.000	.000	.000
	N	327	327	327	327	327	327	327
TU2	Pearson Correlation	-.009	1	.019	-.098	.122*	.271**	.153**
	Sig. (2-tailed)	.871		.734	.076	.027	.000	.006
	N	327	327	327	327	327	327	327
TU3	Pearson Correlation	.561**	.019	1	.488**	.571**	.494**	.594**
	Sig. (2-tailed)	.000	.734		.000	.000	.000	.000
	N	327	327	327	327	327	327	327
TU4	Pearson Correlation	.511**	-.098	.488**	1	.452**	.306**	.460**
	Sig. (2-tailed)	.000	.076	.000		.000	.000	.000
	N	327	327	327	327	327	327	327
TU5	Pearson Correlation	.443**	.122*	.571**	.452**	1	.474**	.537**
	Sig. (2-tailed)	.000	.027	.000	.000		.000	.000
	N	327	327	327	327	327	327	327
TU6	Pearson Correlation	.393**	.271**	.494**	.306**	.474**	1	.566**
	Sig. (2-tailed)	.000	.000	.000	.000	.000		.000
	N	327	327	327	327	327	327	327
TU7	Pearson Correlation	.458**	.153**	.594**	.460**	.537**	.566**	1
	Sig. (2-tailed)	.000	.006	.000	.000	.000	.000	
	N	327	327	327	327	327	327	327
**. Correlation is significant at the 0.01 level (2-tailed).								
*. Correlation is significant at the 0.05 level (2-tailed).								

II. Item Correlation for Employers

Correlations								
		EM1	EM2	EM3	EM4	EM5	EM6	EM7
EM1	Pearson Correlation	1	.656**	.631**	.615**	.633**	.611**	.615**
	Sig. (2-tailed)		.000	.000	.000	.000	.000	.000
	N	327	327	327	327	327	327	327
EM2	Pearson Correlation	.656**	1	.650**	.697**	.609**	.581**	.667**
	Sig. (2-tailed)	.000		.000	.000	.000	.000	.000
	N	327	327	327	327	327	327	327
EM3	Pearson Correlation	.631**	.650**	1	.716**	.632**	.633**	.679**
	Sig. (2-tailed)	.000	.000		.000	.000	.000	.000
	N	327	327	327	327	327	327	327
EM4	Pearson Correlation	.615**	.697**	.716**	1	.713**	.642**	.709**
	Sig. (2-tailed)	.000	.000	.000		.000	.000	.000
	N	327	327	327	327	327	327	327
EM5	Pearson Correlation	.633**	.609**	.632**	.713**	1	.688**	.717**
	Sig. (2-tailed)	.000	.000	.000	.000		.000	.000
	N	327	327	327	327	327	327	327
EM6	Pearson Correlation	.611**	.581**	.633**	.642**	.688**	1	.668**
	Sig. (2-tailed)	.000	.000	.000	.000	.000		.000
	N	327	327	327	327	327	327	327
EM7	Pearson Correlation	.615**	.667**	.679**	.709**	.717**	.668**	1
	Sig. (2-tailed)	.000	.000	.000	.000	.000	.000	
	N	327	327	327	327	327	327	327

** . Correlation is significant at the 0.01 level (2-tailed).

III. Item Correlation for Government Agents

		Correlations						
		GA1	GA2	GA3	GA4	GA5	GA6	GA7
GA1	Pearson Correlation	1	.543**	.415**	.323**	.331**	.334**	.256**
	Sig. (2-tailed)		.000	.000	.000	.000	.000	.000
	N	327	327	327	327	327	327	327
GA2	Pearson Correlation	.543**	1	.500**	.554**	.511**	.385**	.313**
	Sig. (2-tailed)	.000		.000	.000	.000	.000	.000
	N	327	327	327	327	327	327	327
GA3	Pearson Correlation	.415**	.500**	1	.540**	.488**	.372**	.330**
	Sig. (2-tailed)	.000	.000		.000	.000	.000	.000
	N	327	327	327	327	327	327	327
GA4	Pearson Correlation	.323**	.554**	.540**	1	.580**	.424**	.317**
	Sig. (2-tailed)	.000	.000	.000		.000	.000	.000
	N	327	327	327	327	327	327	327
GA5	Pearson Correlation	.331**	.511**	.488**	.580**	1	.449**	.427**
	Sig. (2-tailed)	.000	.000	.000	.000		.000	.000
	N	327	327	327	327	327	327	327
GA6	Pearson Correlation	.334**	.385**	.372**	.424**	.449**	1	.444**
	Sig. (2-tailed)	.000	.000	.000	.000	.000		.000
	N	327	327	327	327	327	327	327
GA7	Pearson Correlation	.256**	.313**	.330**	.317**	.427**	.444**	1
	Sig. (2-tailed)	.000	.000	.000	.000	.000	.000	
	N	327	327	327	327	327	327	327

** . Correlation is significant at the 0.01 level (2-tailed).

IV. Item Correlation for International Buyers

Correlations							
		IB1	IB2	IB3	IB4	IB5	IB6
IB1	Pearson Correlation	1	.278**	.432**	.429**	.346**	.062
	Sig. (2-tailed)		.000	.000	.000	.000	.263
	N	327	327	327	327	327	327
IB2	Pearson Correlation	.278**	1	.491**	.299**	.421**	.426**
	Sig. (2-tailed)	.000		.000	.000	.000	.000
	N	327	327	327	327	327	327
IB3	Pearson Correlation	.432**	.491**	1	.518**	.454**	.354**
	Sig. (2-tailed)	.000	.000		.000	.000	.000
	N	327	327	327	327	327	327
IB4	Pearson Correlation	.429**	.299**	.518**	1	.508**	.281**
	Sig. (2-tailed)	.000	.000	.000		.000	.000
	N	327	327	327	327	327	327
IB5	Pearson Correlation	.346**	.421**	.454**	.508**	1	.444**
	Sig. (2-tailed)	.000	.000	.000	.000		.000
	N	327	327	327	327	327	327
IB6	Pearson Correlation	.062	.426**	.354**	.281**	.444**	1
	Sig. (2-tailed)	.263	.000	.000	.000	.000	
	N	327	327	327	327	327	327

** . Correlation is significant at the 0.01 level (2-tailed).

V. Item Correlation for Industrial Relations

Correlations								
		IR1	IR2	IR3	IR4	IR5	IR6	IR7
IR1	Pearson Correlation	1	.633**	.510**	.608**	.609**	.590**	.544**
	Sig. (2-tailed)		.000	.000	.000	.000	.000	.000
	N	327	327	327	327	327	327	327
IR2	Pearson Correlation	.633**	1	.667**	.621**	.624**	.570**	.556**
	Sig. (2-tailed)	.000		.000	.000	.000	.000	.000
	N	327	327	327	327	327	327	327
IR3	Pearson Correlation	.510**	.667**	1	.728**	.649**	.608**	.531**
	Sig. (2-tailed)	.000	.000		.000	.000	.000	.000
	N	327	327	327	327	327	327	327
IR4	Pearson Correlation	.608**	.621**	.728**	1	.766**	.698**	.610**
	Sig. (2-tailed)	.000	.000	.000		.000	.000	.000
	N	327	327	327	327	327	327	327
IR5	Pearson Correlation	.609**	.624**	.649**	.766**	1	.781**	.697**
	Sig. (2-tailed)	.000	.000	.000	.000		.000	.000
	N	327	327	327	327	327	327	327
IR6	Pearson Correlation	.590**	.570**	.608**	.698**	.781**	1	.744**
	Sig. (2-tailed)	.000	.000	.000	.000	.000		.000
	N	327	327	327	327	327	327	327
IR7	Pearson Correlation	.544**	.556**	.531**	.610**	.697**	.744**	1
	Sig. (2-tailed)	.000	.000	.000	.000	.000	.000	
	N	327	327	327	327	327	327	327

** . Correlation is significant at the 0.01 level (2-tailed).